

TABLE OF CONTENTS
THREADS AND THREADING

SCREW THREAD SYSTEMS	
1712	Screw Thread Forms
1712	V-Thread, Sharp V-thread
1712	US Standard Screw Thread
1712	Unified Screw Thread Forms
1713	International Metric Thread
1714	ISO Metric Thread System
1714	Definitions of Screw Threads
UNIFIED SCREW THREADS	
1719	American Standard for Unified Screw Threads
1719	Revised Standard
1719	Advantages of Unified Threads
1719	Thread Form
1720	Internal and External Screw Thread Design Profile
1720	Thread Series
1721	Inch Screw Thread
1722	Diameter-Pitch Combination
1723	Standard Series Combinations
1750	Coarse-Thread Series
1751	Fine-Thread Series
1751	Extra-Fine-Thread Series
1752	Constant Pitch Series
1753	4-Thread Series
1754	6-Thread Series
1755	8-Thread Series
1756	12-Thread Series
1757	16-Thread Series
1758	20-Thread Series
1759	28-Thread Series
1760	Thread Classes
1760	Coated 60-deg. Threads
1762	Screw Thread Selection
1762	Pitch Diameter Tolerance
1762	Screw Thread Designation
1763	Designating Coated Threads
1763	Designating UNS Threads
1763	Hole Sizes for Tapping
1763	Minor Diameter Tolerance
1764	Unified Miniature Screw Thread
1764	Basic Thread Form
1765	Design Thread Form
1766	Design Form Dimensions
1766	Formulas for Basic Dimensions
1767	Limits of Size and Tolerances
1768	Minimum Root Flats
1769	UNJ Profile

CALCULATING THREAD DIMENSIONS	
1770	Introduction
1770	Metric Application
1770	Purpose
1771	Calculating And Rounding
1771	Rounding of Decimal Values
1771	Calculations from Formulas
1772	Examples
1772	Inch Screw Threads
1772	Metric Screw Threads
1772	Thread Form Constants
METRIC SCREW THREADS	
1783	M Profile Metric Screw Threads
1783	Comparison with Inch Threads
1783	Interchangeability
1783	Definitions
1784	Basic M Profile
1784	M Crest and Root Form
1785	General Symbols
1785	M Profile Screw Thread Series
1785	Mechanical Fastener Coarse Pitch
1786	M Profile Data
1787	Limits and Fits
1791	Limits for Coated Threads
1793	Dimensional Effect of Coating
1793	Formulas for M Profile
1797	Tolerance Grade Comparisons
1797	M Profile Limiting Dimension
1798	Internal Metric Thread
1800	External Metric Thread
1805	MJ Profile Metric Screw Threads
1805	Diameter-Pitch Combinations
1808	Trapezoidal Metric Thread
1808	Comparison of ISO and DIN
1815	ISO Miniature Screw Threads
1815	British Standard Metric Threads
1815	Basic Profile Dimensions
1816	Tolerance System
1816	Fundamental Deviations
1817	Tolerance Grades
1817	Tolerance Positions
1817	Tolerance Classes
1818	Lengths of Thread Engagements
1818	Design Profiles
1818	M Designation

TABLE OF CONTENTS
THREADS AND THREADING

METRIC SCREW THREADS

(Continued)

1819	Fundamental Deviation Formulas
1820	Crest Diameter Tolerance
1820	Limits and Tolerances, Table
1823	Diameter/Pitch Combinations
1823	Limits and Tolerances
1824	Diameter/Pitch Table
1825	Comparison of Thread Systems

ACME SCREW THREADS

1826	General Purpose Acme Threads
1826	Acme Thread Form
1828	Acme Thread Abbreviations
1828	Designation
1828	Basic Dimensions
1828	Formulas for Diameters
1828	Limiting Dimensions
1828	Single-Start Screw Thread Data
1828	Pitch Diameter Allowances
1828	Multiple Start Acme Threads
1833	Pitch Diameter Tolerances
1833	Centralizing Acme Threads
1835	Basic Dimensions
1835	Formulas for Diameters
1835	Limiting Dimensions
1836	Screw Thread Data
1837	Pitch Diameter Allowances
1837	Pitch Diameter Tolerances
1837	Tolerances and Allowances
1838	Designation
1844	Acme Centralizing Thread
1844	Stub Acme Threads
1844	Basic Dimensions
1844	Formulas for Diameters
1844	Limiting Dimensions
1844	Stub Acme Thread Designations
1847	Alternative Stub Acme Threads
1847	Former 60-Degree Stub Thread
1849	Square Thread

BUTTRESS THREADS

1850	Threads of Buttress Form
1850	British Standard Buttress Threads
1850	Lowenherz or Löwenherz Thread
1851	Buttress Inch Screw Threads
1851	Pitch Combinations
1851	Basic Dimensions
1851	Symbols and Form
1852	Buttress Thread Tolerances

BUTTRESS THREADS

(Continued)

1852	Class 2 Tolerances
1853	Buttress Thread Form
1856	Allowances for Easy Assembly
1856	External Thread Allowances
1857	Buttress Thread Designations
1857	Designation Sequence

WHITWORTH THREADS

1858	British Standard Whitworth (BSW) and Fine (BSF) Threads
1858	Standard Thread Form
1858	Whitworth Standard Thread Form
1858	Tolerance Formulas
1859	Basic Dimensions

PIPE AND HOSE THREADS

1861	American National Pipe Threads
1861	Thread Designation and Notation
1861	Taper Pipe Thread
1862	Basic Dimensions
1863	Length of Engagement
1863	Tolerances on Thread Elements
1864	Limits on Crest and Root
1865	Pipe Couplings
1865	Railing Joint
1865	Straight Pipe Threads
1865	Mechanical Joints
1867	Dryseal Pipe Thread
1867	Limits on Crest and Root
1867	Types of Dryseal Pipe Thread
1867	Limitation of Assembly
1869	Tap Drill Sizes
1869	Special Dryseal Threads
1870	Limitations for Combinations
1870	British Standard Pipe Threads
1870	Non-pressure-tight Joints
1871	Basic Sizes
1871	Pressure-tight Joints
1872	Limits of Size
1873	Hose Coupling Screw Threads
1875	Screw Thread Length
1875	Fire Hose Connection
1876	Basic Dimensions
1877	Limits of Size

OTHER THREADS

1878	Interference-Fit Threads
1879	Design and Application Data

TABLE OF CONTENTS
THREADS AND THREADING

OTHER THREADS

(Continued)

1880	External Thread Dimension
1880	Internal Thread Dimension
1881	Engagement Lengths
1882	Allowances for Coarse Thread
1882	Tolerances for Coarse Thread
1883	Variations in Lead and Diameter
1884	Spark Plug Threads
1884	BS Spark Plugs
1884	SAE Spark Plugs
1885	Lamp Base and Socket Threads
1886	Instrument & Microscope Threads
1886	British Association Thread
1887	Instrument Makers' Screw Thread
1887	Microscope Objective Thread
1890	Swiss Screw Thread
1891	Historical and Miscellaneous
1891	Aero-Thread
1891	Briggs Pipe Thread
1891	Casing Thread
1892	Cordeaux Thread
1892	Dardelet Thread
1892	"Drunken" Thread
1892	Echols Thread
1892	French Thread (S.F.)
1892	Harvey Grip Thread
1893	Lloyd & Lloyd Thread
1893	Lock-Nut Pipe Thread
1893	Philadelphia Carriage Bolt Thread
1893	SAE Standard Screw Thread
1893	Sellers Screw Thread

MEASURING SCREW THREADS

1894	Measuring Screw Threads
1894	Pitch and Lead of Screw Threads
1894	Thread Micrometers
1895	Ball-point Micrometers
1895	Three-wire Method
1896	Classes of Formulas
1896	Screw Thread Profiles
1896	Accuracy of Formulas
1897	Best Wire Sizes
1898	Measuring Wire Accuracy
1898	Measuring or Contact Pressure
1898	Three-Wire Formulas
1899	NIST General Formula
1900	Formulas for Pitch Diameters
1900	Effect of Small Thread Angle
1902	Dimensions Over Wires
1902	Formula Including Lead Angle

MEASURING SCREW THREADS

(Continued)

1903	Measuring Whitworth Threads
1904	Buckingham Exact Formula
1905	Accuracy of Formulas
	Acme and Stub Acme Thread
1906	Checking Pitch Diameter
1906	Checking Thread Thickness
1907	Wire Sizes
1907	Checking Thread Angle
1908	Best Wire Diameters
1910	Taper Screw Threads
1911	Buttress Threads
1912	Thread Gages
1912	Thread Gage Classification
1912	Gages for Unified Inch Threads
1915	Thread Forms of Gages
1915	Thread Gage Tolerances
1917	Tolerances for Cylindrical Gages
1919	Formulas for Limits

TAPPING AND THREAD CUTTING

1920	Selection of Taps
1922	Tap Rake Angles
1922	Cutting Speed
1922	Tapping Specific Materials
1925	Diameter of Tap Drill
1926	Hole Size Limits
1934	Tap Drill Sizes
1935	Tap Drills and Clearance Drills
1935	Tolerances of Tapped Holes
1936	Hole Sizes before Tapping
1937	Miniature Screw Threads
1938	Tapping Drill Sizes
1938	ISO Metric Threads
1939	Clearance Holes
1940	Cold Form Tapping
1941	Core Hole Sizes
1942	Tap Drill Sizes
1942	Removing a Broken Tap
1942	Tap Drills for Pipe Taps
1942	Power for Pipe Taps
1943	High-Speed CNC Tapping
1944	Coolant for Tapping
1944	Combined Drilling and Tapping
1945	Relief Angles for Cutting Tools
1947	Lathe Change Gears
1947	Change Gears for Thread Cutting
1947	Compound Gearing

TABLE OF CONTENTS

THREADS AND THREADING

TAPPING AND THREAD CUTTING

(Continued)

1947	Fractional Threads
1948	Change Gears for Metric Pitches
1948	Change Gears, Fractional Ratios
1949	Quick-Change Gearbox Output
1951	Finding Accurate Gear Ratios
1951	Lathe Change-gears
1952	Relieving Helical-Fluted Hobs

THREAD ROLLING

1953	Thread-Rolling Machine
1953	Flat-Die Type
1953	Cylindrical-Die Type
1953	Rate of Production
1954	Precision Thread Rolling
1954	Steels for Thread Rolling
1954	Diameter of Blank
1954	Automatic Screw Machines
1955	Factors Governing the Diameter
1955	Diameter of Threading Roll
1955	Kind of Thread on Roll
1956	Application of Thread Roll
1956	Thread Rolling Speeds and Feeds

THREAD GRINDING

1958	Thread Grinding
1958	Wheels for Thread Grinding
1958	Single-Edge Wheel
1959	Edges for Roughing and Finishing
1959	Multi-ribbed Wheels
1960	Ribbed Wheel for Fine Pitches
1960	Solid Grinding Threads
1960	Number of Wheel Passes
1960	Wheel and Work Rotation
1961	Wheel Speeds
1961	Work Speeds
1961	Truing Grinding Wheels
1961	Wheel Hardness or Grade
1962	Grain Size
1962	Grinding by Centerless Method

THREAD MILLING

1963	Thread Milling
1963	Single-cutter Method
1963	Multiple-cutter Method
1964	Planetary Method
1964	Classes of Work
1965	Pitches of Die-cut Threads

THREAD MILLING

(Continued)

1965	Changing Pitch of Screw
1965	Helical Milling
1965	Lead of a Milling Machine
1966	Change Gears for Helical Milling
1966	Short-lead Milling
1966	Helix
1967	Helix Angles
1968	Change Gears for Different Leads
1978	Lead of Helix
1981	Change Gears and Angles
	Determining Helix Angle
1982	For Given Lead and Diameter
1983	For Given Angle
1983	For Given Lead
1983	For Lead Given DP and Teeth
1983	Determine Lead of Tooth

SIMPLE, COMPOUND, DIFFERENTIAL, AND BLOCK INDEXING

1984	Milling Machine Indexing
1984	Hole Circles
1984	Holes in Brown & Sharpe
1984	Holes in Cincinnati
1984	Simple Indexing
1985	Compound Indexing
1986	Simple and Compound Indexing
1991	Angular Indexing
1991	Tables for Angular Indexing
1992	Angle of One Hole Moves
1993	Accurate Angular Indexing
2008	Indexing for Small Angles
2009	Differential Indexing
2009	Ratio of Gearing
2010	To Find the Indexing Movement
2010	Use of Idler Gears
2010	Compound Gearing
2011	Check Number of Divisions
2012	Simple and Different Indexing
2018	Indexing Movements of Plate
2019	Indexing High Numbers
2022	Indexing Tables
2022	Block or Multiple Indexing
2024	60-Tooth Worm Indexing
2025	Linear Indexing for Rack Cutting
2025	Linear Indexing Movements
2026	Counter Milling

SCREW THREAD SYSTEMS

Screw Thread Forms

Of the various screw thread forms which have been developed, the most used are those having symmetrical sides inclined at equal angles with a vertical center line through the thread apex. Present-day examples of such threads would include the Unified, the Whitworth and the Acme forms. One of the early forms was the Sharp V which is now used only occasionally. Symmetrical threads are relatively easy to manufacture and inspect and hence are widely used on mass-produced general-purpose threaded fasteners of all types. In addition to general-purpose fastener applications, certain threads are used to repeatedly move or translate machine parts against heavy loads. For these so-called translation threads a stronger form is required. The most widely used translation thread forms are the square, the Acme, and the buttress. Of these, the square thread is the most efficient, but it is also the most difficult to cut owing to its parallel sides and it cannot be adjusted to compensate for wear. Although less efficient, the Acme form of thread has none of the disadvantages of the square form and has the advantage of being somewhat stronger. The buttress form is used for translation of loads in one direction only because of its non-symmetrical form and combines the high efficiency and strength of the square thread with the ease of cutting and adjustment of the Acme thread.

V-Thread, Sharp V-thread.—The sides of the thread form an angle of 60 degrees with each other. The top and bottom or root of this thread form are theoretically sharp, but in actual practice the thread is made with a slight flat, owing to the difficulty of producing a perfectly sharp edge and because of the tendency of such an edge to wear away or become battered. This flat is usually equal to about one twenty-fifth of the pitch, although there is no generally recognized standard.

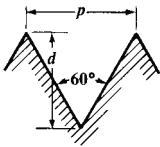

Owing to the difficulties connected with the V-thread, the tap manufacturers agreed in 1909 to discontinue the making of sharp V-thread taps, except when ordered. One advantage of the V-thread is that the same cutting tool may be used for all pitches, whereas, with the American Standard form, the width of the point or the flat varies according to the pitch.

The V-thread is regarded as a good form where a steam-tight joint is necessary, and many of the taps used on locomotive work have this form of thread. Some modified V-threads, for locomotive boiler taps particularly, have a depth of $0.8 \times$ pitch.

The American Standard screw thread is used largely in preference to the sharp V-thread because it has several advantages; see *American Standard for Unified Screw Threads*. If p = pitch of thread, and d depth of thread, then

$$d = p \times \cos 30 \text{ deg.} = 0.866 \times p = \frac{0.866}{\text{No. of threads per inch}}$$

United States Standard Screw Thread.—William Sellers of Philadelphia, in a paper read before the Franklin Institute in 1864, originally proposed the screw thread system that later became known as the U. S. Standard system for screw threads. A report was made to the United States Navy in May, 1868, in which the Sellers system was recommended as a standard for the Navy Department, which accounts for the name of U. S. Standard. The American Standard Screw Thread system is a further development of the United States Standard. The thread form which is known as the American (National) form is the same as the United States Standard form. See *American Standard for Unified Screw Threads*.

American National and Unified Screw Thread Forms.—The American National form (formerly known as the United States Standard) was used for many years for most screws, bolts, and miscellaneous threaded products produced in the United States. The American

National Standard for Unified Screw Threads now in use includes certain modifications of the former standard as is explained below and on page 1719. The basic profile is shown in Fig. 1 and is identical for both UN and UNR screw threads. In this figure H is the height of a sharp V-thread, P is the pitch, D and d are the basic major diameters, D_2 and d_2 are the basic pitch diameters, and D_1 and d_1 are the basic minor diameters. Capital letters are used to designate the internal thread dimensions (D, D_2, D_1), and lowercase letters to designate the external thread dimensions (d, d_2, d_1). Definitions of *Basic Size* and *Basic Profile of Thread* are given on page 1714.

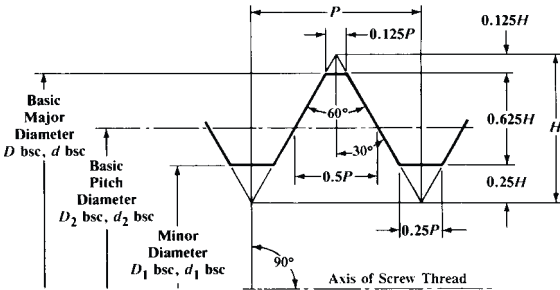
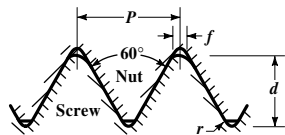

Fig. 1. Basic Profile of UN and UNF Screw Threads

In the past, other symbols were used for some of the thread dimensions illustrated above. These symbols were changed to conform with current practice in nomenclature as defined in ANSI/ASME B1.7M, "Nomenclature, Definitions, and Letter Symbols for Screw Threads." The symbols used above are also in accordance with terminology and symbols used for threads of the ISO metric thread system.

International Metric Thread System.—The *Système Internationale* (S.I.) Thread was adopted at the International Congress for the standardization of screw threads held in Zurich in 1898. The thread form is similar to the American standard (formerly U.S. Standard), excepting the depth which is greater. There is a clearance between the root and mating crest fixed at a maximum of $\frac{1}{16}$ the height of the fundamental triangle or $0.054 \times$ pitch. A rounded root profile is recommended. The angle in the plane of the axis is 60 degrees and the crest has a flat like the American standard equal to $0.125 \times$ pitch. This system formed the basis of the normal metric series (ISO threads) of many European countries, Japan, and many other countries, including metric thread standards of the United States.

Depth $d = 0.7035 P$ max.; $0.6855 P$ min.
 Flat $f = 0.125 P$
 Radius $r = 0.0633 P$ max.; $0.054 P$ min.
 Tap drill dia = major dia. – pitch



International Metric Fine Thread: The International Metric Fine Thread form of thread is the same as the International system but the pitch for a given diameter is smaller.

German Metric Thread Form: The German metric thread form is like the International Standard but the thread depth = $0.6945 P$. The root radius is the same as the maximum for the International Standard or $0.0633 P$.

ISO Metric Thread System.—ISO refers to the International Organization for Standardization, a worldwide federation of national standards bodies (for example, the American National Standards Institute is the ISO national body representing the United States) that develops standards on a very wide variety of subjects.

The basic profile of ISO metric threads is specified in ISO 68 and shown in Fig. 2. The basic profile of this thread is very similar to that of the Unified thread, and as previously discussed, H is the height of a sharp V-thread, P is the pitch, D and d are the basic major diameters, D_2 and d_2 are the basic pitch diameters, and D_1 and d_1 are the basic minor diameters. Here also, capital letters designate the internal thread dimensions (D , D_2 , D_1), and lowercase letters designate the external thread dimensions (d , d_2 , d_1). This metric thread is discussed in detail in the section *METRIC SCREW THREADS* starting on page 1783.

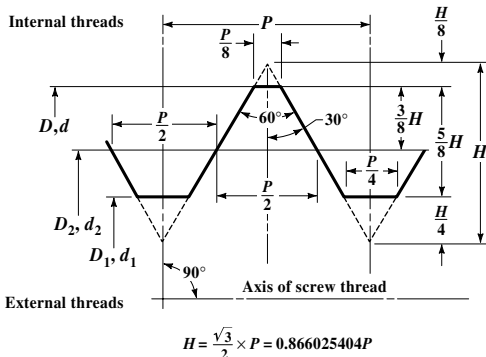

$$0.125H = 0.108253175P \quad 0.250H = 0.216506351P \quad 0.375H = 0.324759526P \quad 0.625H = 0.541265877P$$

Fig. 2. ISO 68 Basic Profile

Definitions of Screw Threads

The following definitions are based on American National Standard ANSI/ASME B1.7M-1984 (R2001) "Nomenclature, Definitions, and Letter Symbols for Screw Threads," and refer to both straight and taper threads.

Actual Size: An actual size is a measured size.

Allowance: An allowance is the prescribed difference between the design (maximum material) size and the basic size. It is numerically equal to the absolute value of the ISO term *fundamental deviation*.

Axis of Thread: Thread axis is coincident with the axis of its pitch cylinder or cone.

Basic Profile of Thread: The basic profile of a thread is the cyclical outline, in an axial plane, of the permanently established boundary between the provinces of the external and internal threads. All deviations are with respect to this boundary.

Basic Size: The basic size is that size from which the limits of size are derived by the application of allowances and tolerances.

Bilateral Tolerance: This is a tolerance in which variation is permitted in both directions from the specified dimension.

Black Crest Thread: This is a thread whose crest displays an unfinished cast, rolled, or forged surface.

Blunt Start Thread: "Blunt start" designates the removal of the incomplete thread at the starting end of the thread. This is a feature of threaded parts that are repeatedly assembled

by hand, such as hose couplings and thread plug gages, to prevent cutting of hands and crossing of threads. It was formerly known as a Higbee cut.

Chamfer: This is a conical surface at the starting end of a thread.

Class of Thread: The class of a thread is an alphanumerical designation to indicate the standard grade of tolerance and allowance specified for a thread.

Clearance Fit: This is a fit having limits of size so prescribed that a clearance always results when mating parts are assembled at their maximum material condition.

Complete Thread: The complete thread is that thread whose profile lies within the size limits. (See also *Effective Thread* and *Length of Complete Thread*.) *Note:* Formerly in pipe thread terminology this was referred to as "the perfect thread" but that term is no longer considered desirable.

Crest: This is that surface of a thread which joins the flanks of the thread and is farthest from the cylinder or cone from which the thread projects.

Crest Truncation: This is the radial distance between the sharp crest (crest apex) and the cylinder or cone that would bound the crest.

Depth of Thread Engagement: The depth (or height) of thread engagement between two coaxially assembled mating threads is the radial distance by which their thread forms overlap each other.

Design Size: This is the basic size with allowance applied, from which the limits of size are derived by the application of a tolerance. If there is no allowance, the design size is the same as the basic size.

Deviation: Deviation is a variation from an established dimension, position, standard, or value. In ISO usage, it is the algebraic difference between a size (actual, maximum, or minimum) and the corresponding basic size. The term deviation does not necessarily indicate an error. (See also *Error*.)

Deviation, Fundamental (ISO term): For standard threads, the fundamental deviation is the upper or lower deviation closer to the basic size. It is the upper deviation es for an external thread and the lower deviation EI for an internal thread. (See also *Allowance* and *Tolerance Position*.)

Deviation, Lower (ISO term): The algebraic difference between the minimum limit of size and the basic size. It is designated EI for internal and ei for external thread diameters.

Deviation, Upper (ISO term): The algebraic difference between the maximum limit of size and the basic size. It is designated ES for internal and es for external thread diameters.

Dimension: A numerical value expressed in appropriate units of measure and indicated on drawings along with lines, symbols, and notes to define the geometrical characteristic of an object.

Effective Size: See *Pitch Diameter, Functional Diameter*.

Effective Thread: The effective (or useful) thread includes the complete thread, and those portions of the incomplete thread which are fully formed at the root but not at the crest (in taper pipe threads it includes the so-called black crest threads); thus excluding the vanish thread.

Error: The algebraic difference between an observed or measured value beyond tolerance limits, and the specified value.

External Thread: A thread on a cylindrical or conical external surface.

Fit: Fit is the relationship resulting from the designed difference, before assembly, between the sizes of two mating parts which are to be assembled.

Flank: The flank of a thread is either surface connecting the crest with the root. The flank surface intersection with an axial plane is theoretically a straight line.

Flank Angle: The flank angles are the angles between the individual flanks and the perpendicular to the axis of the thread, measured in an axial plane. A flank angle of a symmetrical thread is commonly termed the half-angle of thread.

Flank Diametral Displacement: In a boundary profile defined system, flank diametral displacement is twice the radial distance between the straight thread flank segments of the

maximum and minimum boundary profiles. The value of flank diametral displacement is equal to pitch diameter tolerance in a pitch line reference thread system.

Height of Thread: The height (or depth) of thread is the distance, measured radially, between the major and minor cylinders or cones, respectively.

Helix Angle: On a straight thread, the helix angle is the angle made by the helix of the thread and its relation to the thread axis. On a taper thread, the helix angle at a given axial position is the angle made by the conical spiral of the thread with the axis of the thread. The helix angle is the complement of the lead angle. (See also page 1967 for diagram.)

Higbee Cut: See *Blunt Start Thread*.

Imperfect Thread: See *Incomplete Thread*.

Included Angle: This is the angle between the flanks of the thread measured in an axial plane.

Incomplete Thread: A threaded profile having either crests or roots or both, not fully formed, resulting from their intersection with the cylindrical or end surface of the work or the vanish cone. It may occur at either end of the thread.

Interference Fit: A fit having limits of size so prescribed that an interference always results when mating parts are assembled.

Internal Thread: A thread on a cylindrical or conical internal surface.

Lead: Lead is the axial distance between two consecutive points of intersection of a helix by a line parallel to the axis of the cylinder on which it lies, i.e., the axial movement of a threaded part rotated one turn in its mating thread.

Lead Angle: On a straight thread, the lead angle is the angle made by the helix of the thread at the pitch line with a plane perpendicular to the axis. On a taper thread, the lead angle at a given axial position is the angle made by the conical spiral of the thread with the perpendicular to the axis at the pitch line.

Lead Thread: That portion of the incomplete thread that is fully formed at the root but not fully formed at the crest that occurs at the entering end of either an external or internal thread.

Left-hand Thread: A thread is a left-hand thread if, when viewed axially, it winds in a counterclockwise and receding direction. Left-hand threads are designated LH.

Length of Complete Thread: The axial length of a thread section having full form at both crest and root but also including a maximum of two pitches at the start of the thread which may have a chamfer or incomplete crests.

Length of Thread Engagement: The length of thread engagement of two mating threads is the axial distance over which the two threads, each having full form at both crest and root, are designed to contact. (See also *Length of Complete Thread*.)

Limits of Size: The applicable maximum and minimum sizes.

Major Clearance: The radial distance between the root of the internal thread and the crest of the external thread of the coaxially assembled designed forms of mating threads.

Major Cone: The imaginary cone that would bound the crests of an external taper thread or the roots of an internal taper thread.

Major Cylinder: The imaginary cylinder that would bound the crests of an external straight thread or the roots of an internal straight thread.

Major Diameter: On a straight thread the major diameter is that of the major cylinder. On a taper thread the major diameter at a given position on the thread axis is that of the major cone at that position. (See also *Major Cylinder* and *Major Cone*.)

Maximum Material Condition: (MMC): The condition where a feature of size contains the maximum amount of material within the stated limits of size. For example, minimum internal thread size or maximum external thread size.

Minimum Material Condition: (Least Material Condition (LMC)): The condition where a feature of size contains the least amount of material within the stated limits of size. For example, maximum internal thread size or minimum external thread size.

Minor Clearance: The radial distance between the crest of the internal thread and the root of the external thread of the coaxially assembled design forms of mating threads.

Minor Cone: The imaginary cone that would bound the roots of an external taper thread or the crests of an internal taper thread.

Minor Cylinder: The imaginary cylinder that would bound the roots of an external straight thread or the crests of an internal straight thread.

Minor Diameter: On a straight thread the minor diameter is that of the minor cylinder. On a taper thread the minor diameter at a given position on the thread axis is that of the minor cone at that position. (See also *Minor Cylinder* and *Minor Cone*.)

Multiple-Start Thread: A thread in which the lead is an integral multiple, other than one, of the pitch.

Nominal Size: Designation used for general identification.

Parallel Thread: See *Screw Thread*.

Partial Thread: See *Vanish Thread*.

Pitch: The pitch of a thread having uniform spacing is the distance measured parallel with its axis between corresponding points on adjacent thread forms in the same axial plane and on the same side of the axis. Pitch is equal to the lead divided by the number of thread starts.

Pitch Cone: The pitch cone is an imaginary cone of such apex angle and location of its vertex and axis that its surface would pass through a taper thread in such a manner as to make the widths of the thread ridge and the thread groove equal. It is, therefore, located equidistantly between the sharp major and minor cones of a given thread form. On a theoretically perfect taper thread, these widths are equal to one-half the basic pitch. (See also *Axis of Thread* and *Pitch Diameter*.)

Pitch Cylinder: The pitch cylinder is an imaginary cylinder of such diameter and location of its axis that its surface would pass through a straight thread in such a manner as to make the widths of the thread ridge and groove equal. It is, therefore, located equidistantly between the sharp major and minor cylinders of a given thread form. On a theoretically perfect thread these widths are equal to one-half the basic pitch. (See also *Axis of Thread* and *Pitch Diameter*.)

Pitch Diameter: On a straight thread the pitch diameter is the diameter of the pitch cylinder. On a taper thread the pitch diameter at a given position on the thread axis is the diameter of the pitch cone at that position. *Note:* When the crest of a thread is truncated beyond the pitch line, the pitch diameter and pitch cylinder or pitch cone would be based on a theoretical extension of the thread flanks.

Pitch Diameter, Functional Diameter: The functional diameter is the pitch diameter of an enveloping thread with perfect pitch, lead, and flank angles and having a specified length of engagement. It includes the cumulative effect of variations in lead (pitch), flank angle, taper, straightness, and roundness. Variations at the thread crest and root are excluded. Other, nonpreferred terms are *virtual diameter*, *effective size*, *virtual effective diameter*, and *thread assembly diameter*.

Pitch Line: The generator of the cylinder or cone specified in *Pitch Cylinder* and *Pitch Cone*.

Right-hand Thread: A thread is a right-hand thread if, when viewed axially, it winds in a clockwise and receding direction. A thread is considered to be right-hand unless specifically indicated otherwise.

Root: That surface of the thread which joins the flanks of adjacent thread forms and is immediately adjacent to the cylinder or cone from which the thread projects.

Root Truncation: The radial distance between the sharp root (root apex) and the cylinder or cone that would bound the root. See also *Sharp Root (Root Apex)*.

Runout: As applied to screw threads, unless otherwise specified, runout refers to circular runout of major and minor cylinders with respect to the pitch cylinder. Circular runout, in accordance with ANSI Y14.5M, controls cumulative variations of circularity and coaxiality. Runout includes variations due to eccentricity and out-of-roundness. The amount of runout is usually expressed in terms of full indicator movement (FIM).

Screw Thread: A screw thread is a continuous and projecting helical ridge usually of uniform section on a cylindrical or conical surface.

Sharp Crest (Crest Apex): The apex formed by the intersection of the flanks of a thread when extended, if necessary, beyond the crest.

Sharp Root (Root Apex): The apex formed by the intersection of the adjacent flanks of adjacent threads when extended, if necessary, beyond the root.

Standoff: The axial distance between specified reference points on external and internal taper thread members or gages, when assembled with a specified torque or under other specified conditions.

Straight Thread: A straight thread is a screw thread projecting from a cylindrical surface.

Taper Thread: A taper thread is a screw thread projecting from a conical surface.

Tensile Stress Area: The tensile stress area is an arbitrarily selected area for computing the tensile strength of an externally threaded fastener so that the fastener strength is consistent with the basic material strength of the fastener. It is typically defined as a function of pitch diameter and/or minor diameter to calculate a circular cross section of the fastener correcting for the notch and helix effects of the threads.

Thread: A thread is a portion of a screw thread encompassed by one pitch. On a single-start thread it is equal to one turn. (See also *Threads per Inch* and *Turns per Inch*.)

Thread Angle: See *Included Angle*.

Thread Runout: See *Vanish Thread*.

Thread Series: Thread Series are groups of diameter/pitch combinations distinguished from each other by the number of threads per inch applied to specific diameters.

Thread Shear Area: The thread shear area is the total ridge cross-sectional area intersected by a specified cylinder with diameter and length equal to the mating thread engagement. Usually the cylinder diameter for external thread shearing is the minor diameter of the internal thread and for internal thread shearing it is the major diameter of the external thread.

Threads per Inch: The number of threads per inch is the reciprocal of the axial pitch in inches.

Tolerance: The total amount by which a specific dimension is permitted to vary. The tolerance is the difference between the maximum and minimum limits.

Tolerance Class: (metric): The tolerance class (metric) is the combination of a tolerance position with a tolerance grade. It specifies the allowance (fundamental deviation), pitch diameter tolerance (flank diametral displacement), and the crest diameter tolerance.

Tolerance Grade: (metric): The tolerance grade (metric) is a numerical symbol that designates the tolerances of crest diameters and pitch diameters applied to the design profiles.

Tolerance Limit: The variation, positive or negative, by which a size is permitted to depart from the design size.

Tolerance Position: (metric): The tolerance position (metric) is a letter symbol that designates the position of the tolerance zone in relation to the basic size. This position provides the allowance (fundamental deviation).

Total Thread: Includes the complete and all the incomplete thread, thus including the vanish thread and the lead thread.

Transition Fit: A fit having limits of size so prescribed that either a clearance or an interference may result when mating parts are assembled.

Turns per Inch: The number of turns per inch is the reciprocal of the lead in inches.

Unilateral Tolerance: A tolerance in which variation is permitted in one direction from the specified dimension.

Vanish Thread: (Partial Thread, Washout Thread, or Thread Runout): That portion of the incomplete thread which is not fully formed at the root or at crest and root. It is produced by the chamfer at the starting end of the thread forming tool.

Virtual Diameter: See *Pitch Diameter, Functional Diameter*.

Washout Thread: See *Vanish Thread*.

UNIFIED SCREW THREADS

American Standard for Unified Screw Threads

American Standard B1.1-1949 was the first American standard to cover those Unified Thread Series agreed upon by the United Kingdom, Canada, and the United States to obtain screw thread interchangeability among these three nations. These Unified threads are now the basic American standard for fastening types of screw threads. In relation to previous American practice, Unified threads have substantially the same thread form and are mechanically interchangeable with the former American National threads of the same diameter and pitch.

The principal differences between the two systems lie in: 1) application of allowances; 2) variation of tolerances with size; 3) difference in amount of pitch diameter tolerance on external and internal threads; and 4) differences in thread designation.

In the Unified system an allowance is provided on both the Classes 1A and 2A external threads whereas in the American National system only the Class I external thread has an allowance. Also, in the Unified system, the pitch diameter tolerance of an internal thread is 30 per cent greater than that of the external thread, whereas they are equal in the American National system.

Revised Standard.—The revised screw thread standard ANSI/ASME B1.1-1989 (R2001) is much the same as that of ANSI B1.1-1982. The latest symbols in accordance with ANSI/ASME B1.7M-1984 (R2001) Nomenclature, are used. Acceptability criteria are described in ANSI/ASME B1.3M-1992 (R2001), Screw Thread Gaging Systems for Dimensional Acceptability, Inch or Metric Screw Threads (UN, UNR, UNJ, M, and MJ).

Where the letters U, A or B do not appear in the thread designations, the threads conform to the outdated American National screw threads.

Advantages of Unified Threads.—The Unified standard is designed to correct certain production difficulties resulting from the former standard. Often, under the old system, the tolerances of the product were practically absorbed by the combined tool and gage tolerances, leaving little for a working tolerance in manufacture. Somewhat greater tolerances are now provided for nut threads. As contrasted with the old "classes of fit" 1, 2, and 3, for each of which the pitch diameter tolerance on the external and internal threads were equal, the Classes 1B, 2B, and 3B (internal) threads in the new standard have, respectively, a 30 per cent larger pitch diameter tolerance than the 1A, 2A, and 3A (external) threads. Relatively more tolerance is provided for fine threads than for coarse threads of the same pitch. Where previous tolerances were more liberal than required, they were reduced.

Thread Form.—The Design Profiles for Unified screw threads, shown on page 1720, define the maximum material condition for external and internal threads with no allowance and are derived from the Basic Profile, shown on page 1713.

UN External Screw Threads: A flat root contour is specified, but it is necessary to provide for some threading tool crest wear, hence a rounded root contour cleared beyond the $0.25P$ flat width of the Basic Profile is optional.

UNR External Screw Threads: To reduce the rate of threading tool crest wear and to improve fatigue strength of a flat root thread, the Design Profile of the UNR thread has a smooth, continuous, non-reversing contour with a radius of curvature not less than $0.108P$ at any point and blends tangentially into the flanks and any straight segment. At the maximum material condition, the point of tangency is specified to be at a distance not less than $0.625H$ (where H is the height of a sharp V-thread) below the basic major diameter.

UN and UNR External Screw Threads: The Design Profiles of both UN and UNR external screw threads have flat crests. However, in practice, product threads are produced with partially or completely rounded crests. A rounded crest tangent at $0.125P$ flat is shown as an option on page 1720.

UN Internal Screw Thread: In practice it is necessary to provide for some threading tool crest wear, therefore the root of the Design Profile is rounded and cleared beyond the $0.125P$ flat width of the Basic Profile. There is no internal UNR screw thread.

American National Standard Unified Internal and External Screw Thread Design Profiles (Maximum Material Condition). —

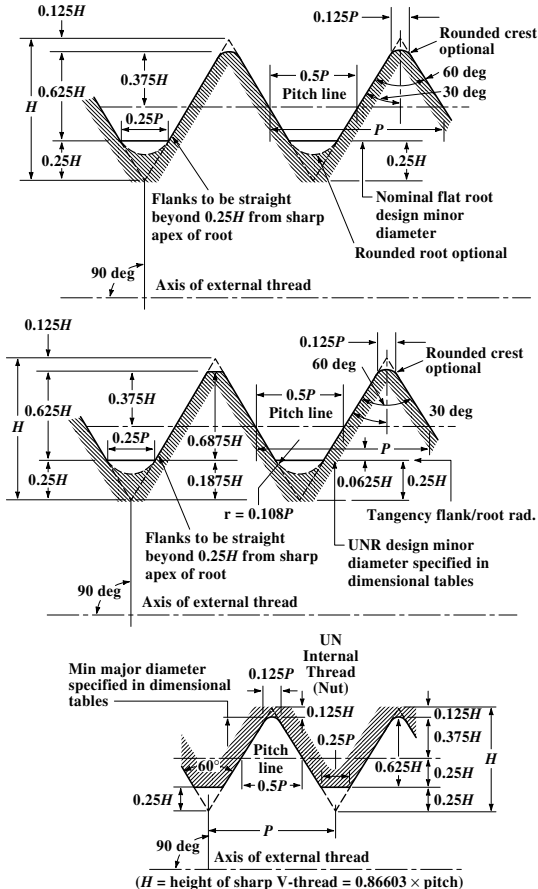

Thread Series.—Thread series are groups of diameter-pitch combinations distinguished from each other by the numbers of threads per inch applied to a specific diameter. The various diameter-pitch combinations of eleven standard series are shown in [Table 2](#). The limits of size of threads in the eleven standard series together with certain selected combinations of diameter and pitch, as well as the symbols for designating the various threads, are given in [Table 3](#). (Text continues on page 1750)

Table 1. American Standard Unified Inch Screw Thread Form Data

Threads per Inch <i>n</i>	Pitch <i>P</i>	Depth of Sharp V-Thread <i>0.86603P</i>	Depth of Int. Thd. and UN Ext. Thd. ^a <i>0.54127P</i>	Depth of UNR Ext. Thd. <i>0.59539P</i>	Truncation of Ext. Thd. Root <i>0.21651P</i>	Truncation of UNR Ext. Thd. Root ^b <i>0.16238P</i>	Truncation of Ext. Thd. Crest <i>0.10825P</i>	Truncation of Int. Thd. Root <i>0.10825P</i>	Truncation of Int. Thd. Crest <i>0.1265P</i>	Flat at Ext. Thd. Crest and Int. Thd. Root <i>0.125P</i>	Basic Flat at Int. Thd. Crest ^c <i>0.25P</i>	Maximum Ext. Thd. Root Radius <i>0.14434P</i>	Addendum of Ext. Thd. <i>0.32476P</i>
80	0.01250	0.01083	0.00677	0.00744	0.00271	0.00203	0.00135	0.00135	0.00271	0.00156	0.00312	0.00180	0.00406
72	0.01389	0.01203	0.00752	0.00827	0.00301	0.00226	0.00150	0.00150	0.00301	0.00174	0.00347	0.00200	0.00451
64	0.01563	0.01353	0.00846	0.00930	0.00338	0.00254	0.00169	0.00169	0.00338	0.00195	0.00391	0.00226	0.00507
56	0.01786	0.01546	0.00967	0.01063	0.00387	0.00290	0.00193	0.00193	0.00387	0.00223	0.00446	0.00258	0.00580
48	0.02083	0.01804	0.01128	0.01240	0.00451	0.00338	0.00226	0.00226	0.00451	0.00260	0.00521	0.00301	0.00677
44	0.02273	0.01968	0.01230	0.01353	0.00492	0.00369	0.00246	0.00246	0.00492	0.00284	0.00568	0.00328	0.00738
40	0.02500	0.02165	0.01353	0.01488	0.00541	0.00406	0.00271	0.00271	0.00541	0.00312	0.00625	0.00361	0.00812
36	0.02778	0.02406	0.01504	0.01654	0.00601	0.00451	0.00301	0.00301	0.00601	0.00347	0.00694	0.00401	0.00902
32	0.03125	0.02706	0.01691	0.01861	0.00677	0.00507	0.00338	0.00338	0.00677	0.00391	0.00781	0.00451	0.01015
28	0.03571	0.03093	0.01933	0.02126	0.00773	0.00580	0.00387	0.00387	0.00773	0.00446	0.00893	0.00515	0.01160
27	0.03704	0.03208	0.02005	0.02205	0.00802	0.00601	0.00401	0.00401	0.00802	0.00463	0.00926	0.00535	0.01203
24	0.04167	0.03608	0.02255	0.02481	0.00902	0.00677	0.00451	0.00451	0.00902	0.00521	0.01042	0.00601	0.01353
20	0.05000	0.04330	0.02706	0.02977	0.01083	0.00812	0.00541	0.00541	0.01083	0.00625	0.01250	0.00722	0.01624
18	0.05556	0.04811	0.03007	0.03308	0.01203	0.00902	0.00601	0.00601	0.01203	0.00694	0.01389	0.00802	0.01804
16	0.06250	0.05413	0.03383	0.03721	0.01353	0.01015	0.00677	0.00677	0.01353	0.00781	0.01562	0.00902	0.02030
14	0.07143	0.06186	0.03866	0.04253	0.01546	0.01160	0.00773	0.00773	0.01546	0.00893	0.01786	0.01031	0.02320
13	0.07692	0.06662	0.04164	0.04580	0.01655	0.01249	0.00833	0.00833	0.01665	0.00962	0.01923	0.01110	0.02498
12	0.08333	0.07217	0.04511	0.04962	0.01804	0.01353	0.00902	0.00902	0.01804	0.01042	0.02083	0.01203	0.02706
11½	0.08696	0.07531	0.04707	0.05177	0.01883	0.01412	0.00941	0.00941	0.01883	0.01087	0.02174	0.01255	0.02824
11	0.09091	0.07873	0.04921	0.05413	0.01968	0.01476	0.00984	0.00984	0.01968	0.01136	0.02273	0.01312	0.02952
10	0.10000	0.08660	0.05413	0.05954	0.02165	0.01624	0.01083	0.01083	0.02165	0.01250	0.02500	0.01443	0.03248
9	0.11111	0.09623	0.06014	0.06615	0.02406	0.01804	0.01203	0.01203	0.02406	0.01389	0.02778	0.01604	0.03608
8	0.12500	0.10825	0.06766	0.07442	0.02706	0.02030	0.01353	0.01353	0.02706	0.01562	0.03125	0.01804	0.04059
7	0.14286	0.12372	0.07732	0.08506	0.03093	0.02320	0.01546	0.01546	0.03093	0.01786	0.03571	0.02062	0.04639
6	0.16667	0.14434	0.09021	0.09923	0.03608	0.02706	0.01804	0.01804	0.03608	0.02083	0.04167	0.02406	0.05413
5	0.20000	0.17321	0.10825	0.11908	0.04330	0.03248	0.02165	0.02165	0.04330	0.02500	0.05000	0.02887	0.06495
4½	0.22222	0.19245	0.12028	0.13231	0.04811	0.03608	0.02406	0.02406	0.04811	0.02778	0.05556	0.03208	0.07217
4	0.25000	0.21651	0.13532	0.14885	0.05413	0.04059	0.02706	0.02706	0.05413	0.03125	0.06250	0.03608	0.08119

^a Also depth of thread engagement.^b Design profile.^c Also basic flat at external UN thread root.

All dimensions are in inches.

Table 2. Diameter-Pitch Combinations for Standard Series of Threads (UN/UNR)

Sizes ^a No. or Inches	Basic Major Dia. Inches	Threads per Inch											
		Series with Graded Pitches			Series with Uniform (Constant) Pitches								
		Coarse UNC	Fine ^b UNF	Extra fine ^c UNEF	4-UN	6-UN	8-UN	12-UN	16-UN	20-UN	28-UN	32-UN	
0	0.0600	...	80	Series designation shown indicates the UN thread form; however, the UNR thread form may be specified by substituting UNR in place of UN in all designations for external threads.									...
(1)	0.0730	64	72										...
2	0.0860	56	64	
(3)	0.0990	48	56	
4	0.1120	40	48	
5	0.1250	40	44	
6	0.1380	32	40	
8	0.1640	32	36	
10	0.1900	24	32	
(12)	0.2160	24	28	32	
1/4	0.2500	20	28	32	UNC	UNC	UNC	UNC	
5/16	0.3125	18	24	32	20	28	UNC	
3/8	0.3750	16	24	32	UNC	20	28	UNC	
7/16	0.4375	14	20	28	16	UNF	UNEF	32	
1/2	0.5000	13	20	28	16	UNF	UNEF	32	
5/8	0.5625	12	18	24	UNC	16	20	28	32	
(1 1/16)	0.6250	11	18	24	12	16	20	28	32	
(1 1/8)	0.6875	24	12	16	20	28	32	
(1 1/4)	0.7500	10	16	20	12	UNF	UNEF	28	32	
(1 3/16)	0.8125	20	12	16	UNEF	28	32	
(1 1/2)	0.8750	9	14	20	12	16	UNEF	28	32	
(1 5/16)	0.9375	20	12	16	UNEF	28	32	
1	1.0000	8	12	20	UNC	UNC	16	UNEF	28	32	
(1 1/8)	1.0625	18	8	12	16	20	28	...	
1 1/8	1.1250	7	12	18	8	UNF	16	20	28	...	
(1 3/16)	1.1875	18	8	12	16	20	28	...	
1 1/4	1.2500	7	12	18	8	UNF	16	20	28	...	
1 3/16	1.3125	18	8	12	16	20	28	...	
1 3/8	1.3750	6	12	18	...	UNC	8	UNF	16	20	28	...	
(1 5/16)	1.4375	18	...	6	8	12	16	20	28	...	
1 1/2	1.5000	6	12	18	...	UNC	8	UNF	16	20	28	...	
(1 7/16)	1.5625	18	...	6	8	12	16	20	
1 3/8	1.6250	18	...	6	8	12	16	20	
(1 9/16)	1.6875	18	...	6	8	12	16	20	
1 3/4	1.7500	5	6	8	12	16	20	
(1 11/16)	1.8125	6	8	12	16	20	
1 7/8	1.8750	6	8	12	16	20	
(1 13/16)	1.9375	6	8	12	16	20	
2	2.0000	4 1/2	6	8	12	16	20	
(2 1/8)	2.1250	6	8	12	16	20	
2 1/4	2.2500	4 1/2	6	8	12	16	20	
(2 3/8)	2.3750	6	8	12	16	20	
2 1/2	2.5000	4	UNC	6	8	12	16	20	
(2 5/8)	2.6250	4	6	8	12	16	20	
2 3/4	2.7500	4	UNC	6	8	12	16	20	
(2 7/8)	2.8750	4	6	8	12	16	20	
3	3.0000	4	UNC	6	8	12	16	20	
(3 1/8)	3.1250	4	6	8	12	16	
3 1/4	3.2500	4	UNC	6	8	12	16	
(3 3/8)	3.3750	4	6	8	12	16	
3 1/2	3.5000	4	UNC	6	8	12	16	
(3 5/8)	3.6250	4	6	8	12	16	
3 3/4	3.7500	4	UNC	6	8	12	16	
(3 7/8)	3.8750	4	6	8	12	16	
4	4.0000	4	UNC	6	8	12	16	

^a Sizes shown in parentheses are secondary sizes. Primary sizes of 4 1/4, 4 1/2, 4 3/4, 5, 5 1/4, 5 1/2, 5 3/4 and 6 inches also are in the 4, 6, 8, 12, and 16 thread series; secondary sizes of 4 1/8, 4 3/8, 4 5/8, 4 7/8, 5 1/8, 5 3/8, 5 5/8, and 5 7/8 also are in the 4, 6, 8, 12, and 16 thread series.

^b For diameters over 1 1/2 inches, use 12-thread series.

^c For diameters over 1 11/16 inches, use 16-thread series.

For UNR thread form substitute UNR for UN for external threads only.

Table 3. Standard Series and Selected Combinations — Unified Screw Threads

Nominal Size, Threads per Inch, and Series Designation ^a	External ^b							Internal ^b						
	Class	Allowance	Major Diameter			Pitch Diameter		UNR Minor Dia., ^c Max (Ref.)	Class	Minor Diameter		Pitch Diameter		Major Diameter
			Max ^d	Min	Min ^e	Max ^d	Min			Min	Max	Min	Max	Min
0-80 UNF	2A	0.0005	0.0595	0.0563	—	0.0514	0.0496	0.0446	2B	0.0465	0.0514	0.0519	0.0542	0.0600
	3A	0.0000	0.0600	0.0568	—	0.0519	0.0506	0.0451	3B	0.0465	0.0514	0.0519	0.0536	0.0600
1-64 UNC	2A	0.0006	0.0724	0.0686	—	0.0623	0.0603	0.0538	2B	0.0561	0.0623	0.0629	0.0655	0.0730
	3A	0.0000	0.0730	0.0692	—	0.0629	0.0614	0.0544	3B	0.0561	0.0623	0.0629	0.0648	0.0730
1-72 UNF	2A	0.0006	0.0724	0.0689	—	0.0634	0.0615	0.0559	2B	0.0580	0.0635	0.0640	0.0665	0.0730
	3A	0.0000	0.0730	0.0695	—	0.0640	0.0626	0.0565	3B	0.0580	0.0635	0.0640	0.0659	0.0730
2-56 UNC	2A	0.0006	0.0854	0.0813	—	0.0738	0.0717	0.0642	2B	0.0667	0.0737	0.0744	0.0772	0.0860
	3A	0.0000	0.0860	0.0819	—	0.0744	0.0728	0.0648	3B	0.0667	0.0737	0.0744	0.0765	0.0860
2-64 UNF	2A	0.0006	0.0854	0.0816	—	0.0753	0.0733	0.0668	2B	0.0691	0.0753	0.0759	0.0786	0.0860
	3A	0.0000	0.0860	0.0822	—	0.0759	0.0744	0.0674	3B	0.0691	0.0753	0.0759	0.0779	0.0860
3-48 UNC	2A	0.0007	0.0983	0.0938	—	0.0848	0.0825	0.0734	2B	0.0764	0.0845	0.0855	0.0885	0.0990
	3A	0.0000	0.0990	0.0945	—	0.0855	0.0838	0.0741	3B	0.0764	0.0845	0.0855	0.0877	0.0990
3-56 UNF	2A	0.0007	0.0983	0.0942	—	0.0867	0.0845	0.0771	2B	0.0797	0.0865	0.0874	0.0902	0.0990
	3A	0.0000	0.0990	0.0949	—	0.0874	0.0858	0.0778	3B	0.0797	0.0865	0.0874	0.0895	0.0990
4-40 UNC	2A	0.0008	0.1112	0.1061	—	0.0950	0.0925	0.0814	2B	0.0849	0.0939	0.0958	0.0991	0.1120
	3A	0.0000	0.1120	0.1069	—	0.0958	0.0939	0.0822	3B	0.0849	0.0939	0.0958	0.0982	0.1120
4-48 UNF	2A	0.0007	0.1113	0.1068	—	0.0978	0.0954	0.0864	2B	0.0894	0.0968	0.0985	0.1016	0.1120
	3A	0.0000	0.1120	0.1075	—	0.0985	0.0967	0.0871	3B	0.0894	0.0968	0.0985	0.1008	0.1120
5-40 UNC	2A	0.0008	0.1242	0.1191	—	0.1080	0.1054	0.0944	2B	0.0979	0.1062	0.1088	0.1121	0.1250
	3A	0.0000	0.1250	0.1199	—	0.1088	0.1069	0.0952	3B	0.0979	0.1062	0.1088	0.1113	0.1250
5-44 UNF	2A	0.0007	0.1243	0.1195	—	0.1095	0.1070	0.0972	2B	0.1004	0.1079	0.1102	0.1134	0.1250
	3A	0.0000	0.1250	0.1202	—	0.1102	0.1083	0.0979	3B	0.1004	0.1079	0.1102	0.1126	0.1250
6-32 UNC	2A	0.0008	0.1372	0.1312	—	0.1169	0.1141	0.1000	2B	0.104	0.114	0.1177	0.1214	0.1380
	3A	0.0000	0.1380	0.1320	—	0.1177	0.1156	0.1008	3B	0.1040	0.1140	0.1177	0.1204	0.1380
6-40 UNF	2A	0.0008	0.1372	0.1321	—	0.1210	0.1184	0.1074	2B	0.111	0.119	0.1218	0.1252	0.1380
	3A	0.0000	0.1380	0.1329	—	0.1218	0.1198	0.1082	3B	0.1110	0.1186	0.1218	0.1243	0.1380
8-32 UNC	2A	0.0009	0.1631	0.1571	—	0.1428	0.1399	0.1259	2B	0.130	0.139	0.1437	0.1475	0.1640
	3A	0.0000	0.1640	0.1580	—	0.1437	0.1415	0.1268	3B	0.1300	0.1389	0.1437	0.1465	0.1640
8-36 UNF	2A	0.0008	0.1632	0.1577	—	0.1452	0.1424	0.1301	2B	0.134	0.142	0.1460	0.1496	0.1640
	3A	0.0000	0.1640	0.1585	—	0.1460	0.1439	0.1309	3B	0.1340	0.1416	0.1460	0.1487	0.1640

UNIFIED SCREW THREADS

1723

Table 3. (Continued) Standard Series and Selected Combinations — Unified Screw Threads

Nominal Size, Threads per Inch, and Series Designation ^a	External ^b							Internal ^b						
	Class	Allow- ance	Major Diameter			Pitch Diameter		UNR Minor Dia., ^c Max (Ref.)	Class	Minor Diameter		Pitch Diameter		Major Diameter
			Max ^d	Min	Min ^e	Max ^d	Min			Min	Max	Min	Max	
10–24 UNC	2A	0.0010	0.1890	0.1818	—	0.1619	0.1586	0.1394	2B	0.145	0.156	0.1629	0.1672	0.1900
	3A	0.0000	0.1900	0.1828	—	0.1629	0.1604	0.1404	3B	0.1450	0.1555	0.1629	0.1661	0.1900
10–28 UNS	2A	0.0010	0.1890	0.1825	—	0.1658	0.1625	0.1464	2B	0.151	0.160	0.1668	0.1711	0.1900
	2A	0.0009	0.1891	0.1831	—	0.1688	0.1658	0.1519	2B	0.156	0.164	0.1697	0.1736	0.1900
10–32 UNF	3A	0.0000	0.1900	0.1840	—	0.1697	0.1674	0.1528	3B	0.1560	0.1641	0.1697	0.1726	0.1900
	2A	0.0009	0.1891	0.1836	—	0.1711	0.1681	0.1560	2B	0.160	0.166	0.1720	0.1759	0.1900
10–36 UNS	2A	0.0009	0.1891	0.1840	—	0.1729	0.1700	0.1592	2B	0.163	0.169	0.1738	0.1775	0.1900
10–40 UNS	2A	0.0009	0.1891	0.1840	—	0.1729	0.1700	0.1592	2B	0.163	0.169	0.1738	0.1775	0.1900
10–48 UNS	2A	0.0008	0.1892	0.1847	—	0.1757	0.1731	0.1644	2B	0.167	0.172	0.1765	0.1799	0.1900
10–56 UNS	2A	0.0007	0.1893	0.1852	—	0.1777	0.1752	0.1681	2B	0.171	0.175	0.1784	0.1816	0.1900
	2A	0.0010	0.2150	0.2078	—	0.1879	0.1845	0.1654	2B	0.171	0.181	0.1889	0.1933	0.2160
12–24 UNC	3A	0.0000	0.2160	0.2088	—	0.1889	0.1863	0.1664	3B	0.1710	0.1807	0.1889	0.1922	0.2160
	2A	0.0010	0.2150	0.2085	—	0.1918	0.1886	0.1724	2B	0.177	0.186	0.1928	0.1970	0.2160
12–28 UNF	3A	0.0000	0.2160	0.2095	—	0.1928	0.1904	0.1734	3B	0.1770	0.1857	0.1928	0.1959	0.2160
	2A	0.0009	0.2151	0.2091	—	0.1948	0.1917	0.1779	2B	0.182	0.190	0.1957	0.1998	0.2160
12–32 UNEF	3A	0.0000	0.2160	0.2100	—	0.1957	0.1933	0.1788	3B	0.1820	0.1895	0.1957	0.1988	0.2160
	2A	0.0009	0.2151	0.2096	—	0.1971	0.1941	0.1821	2B	0.186	0.192	0.1980	0.2019	0.2160
12–36 UNS	2A	0.0009	0.2151	0.2100	—	0.1989	0.1960	0.1835	2B	0.189	0.195	0.1998	0.2035	0.2160
12–40 UNS	2A	0.0009	0.2151	0.2100	—	0.1989	0.1960	0.1835	2B	0.189	0.195	0.1998	0.2035	0.2160
12–48 UNS	2A	0.0008	0.2152	0.2107	—	0.2017	0.1991	0.1904	2B	0.193	0.198	0.2025	0.2059	0.2160
12–56 UNS	2A	0.0007	0.2153	0.2112	—	0.2037	0.2012	0.1941	2B	0.197	0.201	0.2044	0.2076	0.2160
1/4–20 UNC	1A	0.0011	0.2489	0.2367	—	0.2164	0.2108	0.1894	1B	0.196	0.207	0.2175	0.2248	0.2500
	2A	0.0011	0.2489	0.2408	0.2367	0.2164	0.2127	0.1894	2B	0.196	0.207	0.2175	0.2224	0.2500
	3A	0.0000	0.2500	0.2419	—	0.2175	0.2147	0.1905	3B	0.1960	0.2067	0.2175	0.2211	0.2500
1/4–24 UNS	2A	0.0011	0.2489	0.2417	—	0.2218	0.2181	0.1993	2B	0.205	0.215	0.2229	0.2277	0.2500
1/4–27 UNS	2A	0.0010	0.2490	0.2423	—	0.2249	0.2214	0.2049	2B	0.210	0.219	0.2259	0.2304	0.2500
1/4–28 UNF	1A	0.0010	0.2490	0.2392	—	0.2258	0.2208	0.2064	1B	0.211	0.220	0.2268	0.2333	0.2500
	2A	0.0010	0.2490	0.2425	—	0.2258	0.2225	0.2064	2B	0.211	0.220	0.2268	0.2311	0.2500
	3A	0.0000	0.2500	0.2435	—	0.2268	0.2243	0.2074	3B	0.2110	0.2190	0.2268	0.2300	0.2500
1/4–32 UNEF	2A	0.0010	0.2490	0.2430	—	0.2287	0.2255	0.2118	2B	0.216	0.224	0.2297	0.2339	0.2500
	3A	0.0000	0.2500	0.2440	—	0.2297	0.2273	0.2128	3B	0.2160	0.2229	0.2297	0.2328	0.2500

Table 3. (Continued) Standard Series and Selected Combinations — Unified Screw Threads

Nominal Size, Threads per Inch, and Series Designation ^a	External ^b							Internal ^b						
	Class	Allow- ance	Major Diameter			Pitch Diameter		UNR Minor Dia., ^c Max (Ref.)	Class	Minor Diameter		Pitch Diameter		Major Diameter
			Max ^d	Min	Min ^e	Max ^d	Min			Min	Max	Min	Max	
1/4-36 UNS	2A	0.0009	0.2491	0.2436	—	0.2311	0.2280	0.2161	2B	0.220	0.226	0.2320	0.2360	0.2500
1/4-40 UNS	2A	0.0009	0.2491	0.2440	—	0.2329	0.2300	0.2193	2B	0.223	0.229	0.2338	0.2376	0.2500
1/4-48 UNS	2A	0.0008	0.2492	0.2447	—	0.2357	0.2330	0.2243	2B	0.227	0.232	0.2365	0.2401	0.2500
1/4-56 UNS	2A	0.0008	0.2492	0.2451	—	0.2376	0.2350	0.2280	2B	0.231	0.235	0.2384	0.2417	0.2500
5/16-18 UNC	1A	0.0012	0.3113	0.2982	—	0.2752	0.2691	0.2452	1B	0.252	0.265	0.2764	0.2843	0.3125
	2A	0.0012	0.3113	0.3026	0.2982	0.2752	0.2712	0.2452	2B	0.252	0.265	0.2764	0.2817	0.3125
	3A	0.0000	0.3125	0.3038	—	0.2764	0.2734	0.2464	3B	0.2520	0.2630	0.2764	0.2803	0.3125
5/16-20 UN	2A	0.0012	0.3113	0.3032	—	0.2788	0.2748	0.2518	2B	0.258	0.270	0.2800	0.2852	0.3125
	3A	0.0000	0.3125	0.3044	—	0.2800	0.2770	0.2530	3B	0.2580	0.2680	0.2800	0.2839	0.3125
5/16-24 UNF	1A	0.0011	0.3114	0.3006	—	0.2843	0.2788	0.2618	1B	0.267	0.277	0.2854	0.2925	0.3125
	2A	0.0011	0.3114	0.3042	—	0.2843	0.2806	0.2618	2B	0.267	0.277	0.2854	0.2902	0.3125
	3A	0.0000	0.3125	0.3053	—	0.2854	0.2827	0.2629	3B	0.2670	0.2754	0.2854	0.2890	0.3125
5/16-27 UNS	2A	0.0010	0.3115	0.3048	—	0.2874	0.2839	0.2674	2B	0.272	0.281	0.2884	0.2929	0.3125
5/16-28 UN	2A	0.0010	0.3115	0.3050	—	0.2883	0.2849	0.2689	2B	0.274	0.282	0.2893	0.2937	0.3125
	3A	0.0000	0.3125	0.3060	—	0.2893	0.2867	0.2699	3B	0.2740	0.2807	0.2893	0.2926	0.3125
5/16-32 UNEF	2A	0.0010	0.3115	0.3055	—	0.2912	0.2880	0.2743	2B	0.279	0.286	0.2922	0.2964	0.3125
	3A	0.0000	0.3125	0.3065	—	0.2922	0.2898	0.2753	3B	0.2790	0.2847	0.2922	0.2953	0.3125
5/16-36 UNS	2A	0.0009	0.3116	0.3061	—	0.2936	0.2905	0.2785	2B	0.282	0.289	0.2945	0.2985	0.3125
5/16-40 UNS	2A	0.0009	0.3116	0.3065	—	0.2954	0.2925	0.2818	2B	0.285	0.291	0.2963	0.3001	0.3125
5/16-48 UNS	2A	0.0008	0.3117	0.3072	—	0.2982	0.2955	0.2869	2B	0.290	0.295	0.2990	0.3026	0.3125
3/8-16 UNC	1A	0.0013	0.3737	0.3595	—	0.3331	0.3266	0.2992	1B	0.307	0.321	0.3344	0.3429	0.3750
	2A	0.0013	0.3737	0.3643	0.3595	0.3331	0.3287	0.2992	2B	0.307	0.321	0.3344	0.3401	0.3750
	3A	0.0000	0.3750	0.3656	—	0.3344	0.3311	0.3005	3B	0.3070	0.3182	0.3344	0.3387	0.3750
3/8-18 UNS	2A	0.0013	0.3737	0.3650	—	0.3376	0.3333	0.3076	2B	0.315	0.328	0.3389	0.3445	0.3750
3/8-20 UN	2A	0.0012	0.3738	0.3657	—	0.3413	0.3372	0.3143	2B	0.321	0.332	0.3425	0.3479	0.3750
	3A	0.0000	0.3750	0.3669	—	0.3425	0.3394	0.3155	3B	0.3210	0.3297	0.3425	0.3465	0.3750

Table 3. (Continued) Standard Series and Selected Combinations — Unified Screw Threads

Nominal Size, Threads per Inch, and Series Designation ^a	External ^b								Internal ^b					
	Class	Allow- ance	Major Diameter			Pitch Diameter		UNR Minor Dia., ^c Max (Ref.)	Class	Minor Diameter		Pitch Diameter		Major Diameter
			Max ^d	Min	Min ^e	Max ^d	Min			Min	Max	Min	Max	
$\frac{3}{8}$ -24 UNF	1A	0.0011	0.3739	0.3631	—	0.3468	0.3411	0.3243	1B	0.330	0.340	0.3479	0.3553	0.3750
	2A	0.0011	0.3739	0.3667	—	0.3468	0.3430	0.3243	2B	0.330	0.340	0.3479	0.3528	0.3750
$\frac{3}{8}$ -24 UNS	3A	0.0000	0.3750	0.3678	—	0.3479	0.3450	0.3254	3B	0.3300	0.3372	0.3479	0.3516	0.3750
$\frac{3}{8}$ -27 UNS	2A	0.0011	0.3739	0.3672	—	0.3498	0.3462	0.3298	2B	0.335	0.344	0.3509	0.3556	0.3750
$\frac{3}{8}$ -28 UN	2A	0.0011	0.3739	0.3674	—	0.3507	0.3471	0.3313	2B	0.336	0.345	0.3518	0.3564	0.3750
	3A	0.0000	0.3750	0.3685	—	0.3518	0.3491	0.3324	3B	0.3360	0.3426	0.3518	0.3553	0.3750
$\frac{3}{8}$ -32 UNEF	2A	0.0010	0.3740	0.3680	—	0.3537	0.3503	0.3368	2B	0.341	0.349	0.3547	0.3591	0.3750
	3A	0.0000	0.3750	0.3690	—	0.3547	0.3522	0.3378	3B	0.3410	0.3469	0.3547	0.3580	0.3750
$\frac{3}{8}$ -36 UNS	2A	0.0010	0.3740	0.3685	—	0.3560	0.3528	0.3409	2B	0.345	0.352	0.3570	0.3612	0.3750
$\frac{3}{8}$ -40 UNS	2A	0.0009	0.3741	0.3690	—	0.3579	0.3548	0.3443	2B	0.348	0.354	0.3588	0.3628	0.3750
0.390-27 UNS	2A	0.0011	0.3889	0.3822	—	0.3648	0.3612	0.3448	2B	0.350	0.359	0.3659	0.3706	0.3900
$\frac{7}{16}$ -14 UNC	1A	0.0014	0.4361	0.4206	—	0.3897	0.3826	0.3511	1B	0.360	0.376	0.3911	0.4003	0.4375
	2A	0.0014	0.4361	0.4258	0.4206	0.3897	0.3850	0.3511	2B	0.360	0.376	0.3911	0.3972	0.4375
	3A	0.0000	0.4375	0.4272	—	0.3911	0.3876	0.3525	3B	0.3600	0.3717	0.3911	0.3957	0.4375
$\frac{7}{16}$ -16 UN	2A	0.0014	0.4361	0.4267	—	0.3955	0.3909	0.3616	2B	0.370	0.384	0.3969	0.4028	0.4375
	3A	0.0000	0.4375	0.4281	—	0.3969	0.3935	0.3630	3B	0.3700	0.3800	0.3969	0.4014	0.4375
$\frac{7}{16}$ -18 UNS	2A	0.0013	0.4362	0.4275	—	0.4001	0.3958	0.3701	2B	0.377	0.390	0.4014	0.4070	0.4375
$\frac{7}{16}$ -20 UNF	1A	0.0013	0.4362	0.4240	—	0.4037	0.3975	0.3767	1B	0.383	0.395	0.4050	0.4131	0.4375
	2A	0.0013	0.4362	0.4281	—	0.4037	0.3995	0.3767	2B	0.383	0.395	0.4050	0.4104	0.4375
	3A	0.0000	0.4375	0.4294	—	0.4050	0.4019	0.3780	3B	0.3830	0.3916	0.4050	0.4091	0.4375
$\frac{7}{16}$ -24 UNS	2A	0.0011	0.4364	0.4292	—	0.4093	0.4055	0.3868	2B	0.392	0.402	0.4104	0.4153	0.4375
$\frac{7}{16}$ -27 UNS	2A	0.0011	0.4364	0.4297	—	0.4123	0.4087	0.3923	2B	0.397	0.406	0.4134	0.4181	0.4375
$\frac{7}{16}$ -28 UNEF	2A	0.0011	0.4364	0.4299	—	0.4132	0.4096	0.3938	2B	0.399	0.407	0.4143	0.4189	0.4375
	3A	0.0000	0.4375	0.4310	—	0.4143	0.4116	0.3949	3B	0.3990	0.4051	0.4143	0.4178	0.4375
$\frac{7}{16}$ -32 UN	2A	0.0010	0.4365	0.4305	—	0.4162	0.4128	0.3993	2B	0.404	0.411	0.4172	0.4216	0.4375
	3A	0.0000	0.4375	0.4315	—	0.4172	0.4147	0.4003	3B	0.4040	0.4094	0.4172	0.4205	0.4375

Table 3. (Continued) Standard Series and Selected Combinations — Unified Screw Threads

Nominal Size, Threads per Inch, and Series Designation ^a	External ^b							Internal ^b						
	Class	Allow- ance	Major Diameter			Pitch Diameter		UNR Minor Dia., ^c Max (Ref.)	Class	Minor Diameter		Pitch Diameter		Major Diameter
			Max ^d	Min	Min ^e	Max ^d	Min			Min	Max	Min	Max	
1/2-12 UNS	2A	0.0016	0.4984	0.4870	—	0.4443	0.4389	0.3992	2B	0.410	0.428	0.4459	0.4529	0.5000
	3A	0.0000	0.5000	0.4886	—	0.4459	0.4419	0.4008	3B	0.4100	0.4223	0.4459	0.4511	0.5000
1/2-13 UNC	1A	0.0015	0.4985	0.4822	—	0.4485	0.4411	0.4069	1B	0.417	0.434	0.4500	0.4597	0.5000
	2A	0.0015	0.4985	0.4876	0.4822	0.4485	0.4435	0.4069	2B	0.417	0.434	0.4500	0.4565	0.5000
	3A	0.0000	0.5000	0.4891	—	0.4500	0.4463	0.4084	3B	0.4170	0.4284	0.4500	0.4548	0.5000
1/2-14 UNS	2A	0.0015	0.4985	0.4882	—	0.4521	0.4471	0.4135	2B	0.423	0.438	0.4536	0.4601	0.5000
1/2-16 UN	2A	0.0014	0.4986	0.4892	—	0.4580	0.4533	0.4241	2B	0.432	0.446	0.4594	0.4655	0.5000
	3A	0.0000	0.5000	0.4906	—	0.4594	0.4559	0.4255	3B	0.4320	0.4419	0.4594	0.4640	0.5000
1/2-18 UNS	2A	0.0013	0.4987	0.4900	—	0.4626	0.4582	0.4326	2B	0.440	0.453	0.4639	0.4697	0.5000
1/2-20 UNF	1A	0.0013	0.4987	0.4865	—	0.4662	0.4598	0.4392	1B	0.446	0.457	0.4675	0.4759	0.5000
	2A	0.0013	0.4987	0.4906	—	0.4662	0.4619	0.4392	2B	0.446	0.457	0.4675	0.4731	0.5000
	3A	0.0000	0.5000	0.4919	—	0.4675	0.4643	0.4405	3B	0.4460	0.4537	0.4675	0.4717	0.5000
1/2-24 UNS	2A	0.0012	0.4988	0.4916	—	0.4717	0.4678	0.4492	2B	0.455	0.465	0.4729	0.4780	0.5000
1/2-27 UNS	2A	0.0011	0.4989	0.4922	—	0.4748	0.4711	0.4548	2B	0.460	0.469	0.4759	0.4807	0.5000
1/2-28 UNEF	2A	0.0011	0.4989	0.4924	—	0.4757	0.4720	0.4563	2B	0.461	0.470	0.4768	0.4816	0.5000
	3A	0.0000	0.5000	0.4935	—	0.4768	0.4740	0.4574	3B	0.4610	0.4676	0.4768	0.4804	0.5000
1/2-32 UN	2A	0.0010	0.4990	0.4930	—	0.4787	0.4752	0.4618	2B	0.466	0.474	0.4797	0.4842	0.5000
	3A	0.0000	0.5000	0.4940	—	0.4797	0.4771	0.4628	3B	0.4660	0.4719	0.4797	0.4831	0.5000
	1A	0.0016	0.5609	0.5437	—	0.5068	0.4990	0.4617	1B	0.472	0.490	0.5084	0.5186	0.5625
1/16-12 UNC	2A	0.0016	0.5609	0.5495	0.5437	0.5068	0.5016	0.4617	2B	0.472	0.490	0.5084	0.5152	0.5625
	3A	0.0000	0.5625	0.5511	—	0.5084	0.5045	0.4633	3B	0.4720	0.4843	0.5084	0.5135	0.5625
1/16-14 UNS	2A	0.0015	0.5610	0.5507	—	0.5146	0.5096	0.4760	2B	0.485	0.501	0.5161	0.5226	0.5625
1/16-16 UN	2A	0.0014	0.5611	0.5517	—	0.5205	0.5158	0.4866	2B	0.495	0.509	0.5219	0.5280	0.5625
	3A	0.0000	0.5625	0.5531	—	0.5219	0.5184	0.4880	3B	0.4950	0.5040	0.5219	0.5265	0.5625
1/16-18 UNF	1A	0.0014	0.5611	0.5480	—	0.5250	0.5182	0.4950	1B	0.502	0.515	0.5264	0.5353	0.5625
	2A	0.0014	0.5611	0.5524	—	0.5250	0.5205	0.4950	2B	0.502	0.515	0.5264	0.5323	0.5625
	3A	0.0000	0.5625	0.5538	—	0.5264	0.5230	0.4964	3B	0.5020	0.5106	0.5264	0.5308	0.5625

Table 3. (Continued) Standard Series and Selected Combinations — Unified Screw Threads

Nominal Size, Threads per Inch, and Series Designation ^a	External ^b							Internal ^b						
	Class	Allow- ance	Major Diameter			Pitch Diameter		UNR Minor Dia., ^c Max (Ref.)	Class	Minor Diameter		Pitch Diameter		Major Diameter
			Max ^d	Min	Min ^e	Max ^d	Min			Min	Max	Min	Max	
$\frac{1}{16}$ -20 UN	2A	0.0013	0.5612	0.5531	—	0.5287	0.5245	0.5017	2B	0.508	0.520	0.5300	0.5355	0.5625
	3A	0.0000	0.5625	0.5544	—	0.5300	0.5268	0.5030	3B	0.5080	0.5162	0.5300	0.5341	0.5625
$\frac{1}{16}$ -24 UNEF	2A	0.0012	0.5613	0.5541	—	0.5342	0.5303	0.5117	2B	0.517	0.527	0.5354	0.5405	0.5625
	3A	0.0000	0.5625	0.5553	—	0.5354	0.5325	0.5129	3B	0.5170	0.5244	0.5354	0.5392	0.5625
$\frac{1}{16}$ -27 UNS	2A	0.0011	0.5614	0.5547	—	0.5373	0.5336	0.5173	2B	0.522	0.531	0.5384	0.5432	0.5625
$\frac{1}{16}$ -28 UN	2A	0.0011	0.5614	0.5549	—	0.5382	0.5345	0.5188	2B	0.524	0.532	0.5393	0.5441	0.5625
	3A	0.0000	0.5625	0.5560	—	0.5393	0.5365	0.5199	3B	0.5240	0.5301	0.5393	0.5429	0.5625
$\frac{1}{16}$ -32 UN	2A	0.0010	0.5615	0.5555	—	0.5412	0.5377	0.5243	2B	0.529	0.536	0.5422	0.5467	0.5625
	3A	0.0000	0.5625	0.5565	—	0.5422	0.5396	0.5253	3B	0.5290	0.5344	0.5422	0.5456	0.5625
$\frac{5}{8}$ -11 UNC	1A	0.0016	0.6234	0.6052	—	0.5644	0.5561	0.5152	1B	0.527	0.546	0.5660	0.5767	0.6250
	2A	0.0016	0.6234	0.6113	0.6052	0.5644	0.5589	0.5152	2B	0.527	0.546	0.5660	0.5732	0.6250
$\frac{5}{8}$ -12 UN	3A	0.0000	0.6250	0.6129	—	0.5660	0.5619	0.5168	3B	0.5270	0.5391	0.5660	0.5714	0.6250
	2A	0.0016	0.6234	0.6120	—	0.5693	0.5639	0.5242	2B	0.535	0.553	0.5709	0.5780	0.6250
$\frac{5}{8}$ -14 UNS	3A	0.0000	0.6250	0.6136	—	0.5709	0.5668	0.5258	3B	0.5350	0.5463	0.5709	0.5762	0.6250
	2A	0.0015	0.6235	0.6132	—	0.5771	0.5720	0.5385	2B	0.548	0.564	0.5786	0.5852	0.6250
$\frac{5}{8}$ -16 UN	2A	0.0014	0.6236	0.6142	—	0.5830	0.5782	0.5491	2B	0.557	0.571	0.5844	0.5906	0.6250
	3A	0.0000	0.6250	0.6156	—	0.5844	0.5808	0.5505	3B	0.5570	0.5662	0.5844	0.5890	0.6250
$\frac{5}{8}$ -18 UNF	1A	0.0014	0.6236	0.6105	—	0.5875	0.5805	0.5575	1B	0.565	0.578	0.5889	0.5980	0.6250
	2A	0.0014	0.6236	0.6149	—	0.5875	0.5828	0.5575	2B	0.565	0.578	0.5889	0.5949	0.6250
$\frac{5}{8}$ -20 UN	3A	0.0000	0.6250	0.6163	—	0.5889	0.5854	0.5589	3B	0.5650	0.5730	0.5889	0.5934	0.6250
	2A	0.0013	0.6237	0.6156	—	0.5912	0.5869	0.5642	2B	0.571	0.582	0.5925	0.5981	0.6250
$\frac{5}{8}$ -24 UNEF	3A	0.0000	0.6250	0.6169	—	0.5925	0.5893	0.5655	3B	0.5710	0.5787	0.5925	0.5967	0.6250
	2A	0.0012	0.6238	0.6166	—	0.5967	0.5927	0.5742	2B	0.580	0.590	0.5979	0.6031	0.6250
$\frac{5}{8}$ -27 UNS	3A	0.0000	0.6250	0.6178	—	0.5979	0.5949	0.5754	3B	0.5800	0.5869	0.5979	0.6018	0.6250
	2A	0.0011	0.6239	0.6172	—	0.5998	0.5960	0.5798	2B	0.585	0.594	0.6009	0.6059	0.6250
$\frac{5}{8}$ -28 UN	2A	0.0011	0.6239	0.6174	—	0.6007	0.5969	0.5813	2B	0.586	0.595	0.6018	0.6067	0.6250
	3A	0.0000	0.6250	0.6185	—	0.6018	0.5990	0.5824	3B	0.5860	0.5926	0.6018	0.6055	0.6250

Table 3. (Continued) Standard Series and Selected Combinations — Unified Screw Threads

Nominal Size, Threads per Inch, and Series Designation ^a	External ^b								Internal ^b					
	Class	Allow- ance	Major Diameter			Pitch Diameter		UNR Minor Dia., ^c Max (Ref.)	Class	Minor Diameter		Pitch Diameter		Major Diameter
			Max ^d	Min	Min ^e	Max ^d	Min			Min	Max	Min	Max	
$\frac{5}{8}$ -32 UN	2A	0.0011	0.6239	0.6179	—	0.6036	0.6000	0.5867	2B	0.591	0.599	0.6047	0.6093	0.6250
	3A	0.0000	0.6250	0.6190	—	0.6047	0.6020	0.5878	3B	0.5910	0.5969	0.6047	0.6082	0.6250
$\frac{11}{16}$ -12 UN	2A	0.0016	0.6859	0.6745	—	0.6318	0.6264	0.5867	2B	0.597	0.615	0.6334	0.6405	0.6875
	3A	0.0000	0.6875	0.6761	—	0.6334	0.6293	0.5883	3B	0.5970	0.6085	0.6334	0.6387	0.6875
$\frac{11}{16}$ -16 UN	2A	0.0014	0.6861	0.6767	—	0.6455	0.6407	0.6116	2B	0.620	0.634	0.6469	0.6531	0.6875
	3A	0.0000	0.6875	0.6781	—	0.6469	0.6433	0.6130	3B	0.6200	0.6284	0.6469	0.6515	0.6875
$\frac{11}{16}$ -20 UN	2A	0.0013	0.6862	0.6781	—	0.6537	0.6494	0.6267	2B	0.633	0.645	0.6550	0.6606	0.6875
	3A	0.0000	0.6875	0.6794	—	0.6550	0.6518	0.6280	3B	0.6330	0.6412	0.6550	0.6592	0.6875
$\frac{11}{16}$ -24 UNEF	2A	0.0012	0.6863	0.6791	—	0.6592	0.6552	0.6367	2B	0.642	0.652	0.6604	0.6656	0.6875
	3A	0.0000	0.6875	0.6803	—	0.6604	0.6574	0.6379	3B	0.6420	0.6494	0.6604	0.6643	0.6875
$\frac{11}{16}$ -28 UN	2A	0.0011	0.6864	0.6799	—	0.6632	0.6594	0.6438	2B	0.649	0.657	0.6643	0.6692	0.6875
	3A	0.0000	0.6875	0.6810	—	0.6643	0.6615	0.6449	3B	0.6490	0.6551	0.6643	0.6680	0.6875
$\frac{11}{16}$ -32 UN	2A	0.0011	0.6864	0.6804	—	0.6661	0.6625	0.6492	2B	0.654	0.661	0.6672	0.6718	0.6875
	3A	0.0000	0.6875	0.6815	—	0.6672	0.6645	0.6503	3B	0.6540	0.6594	0.6672	0.6707	0.6875
$\frac{3}{4}$ -10 UNC	1A	0.0018	0.7482	0.7288	—	0.6832	0.6744	0.6291	1B	0.642	0.663	0.6850	0.6965	0.7500
	2A	0.0018	0.7482	0.7353	0.7288	0.6832	0.6773	0.6291	2B	0.642	0.663	0.6850	0.6927	0.7500
	3A	0.0000	0.7500	0.7371	—	0.6850	0.6806	0.6309	3B	0.6420	0.6545	0.6850	0.6907	0.7500
$\frac{3}{4}$ -12 UN	2A	0.0017	0.7483	0.7369	—	0.6942	0.6887	0.6491	2B	0.660	0.678	0.6959	0.7031	0.7500
	3A	0.0000	0.7500	0.7386	—	0.6959	0.6918	0.6508	3B	0.6600	0.6707	0.6959	0.7013	0.7500
$\frac{3}{4}$ -14 UNS	2A	0.0015	0.7485	0.7382	—	0.7021	0.6970	0.6635	2B	0.673	0.688	0.7036	0.7103	0.7500
	1A	0.0015	0.7485	0.7343	—	0.7079	0.7004	0.6740	1B	0.682	0.696	0.7094	0.7192	0.7500
$\frac{3}{4}$ -16 UNF	2A	0.0015	0.7485	0.7391	—	0.7079	0.7029	0.6740	2B	0.682	0.696	0.7094	0.7159	0.7500
	3A	0.0000	0.7500	0.7406	—	0.7094	0.7056	0.6755	3B	0.6820	0.6908	0.7094	0.7143	0.7500
$\frac{3}{4}$ -18 UNS	2A	0.0014	0.7486	0.7399	—	0.7125	0.7079	0.6825	2B	0.690	0.703	0.7139	0.7199	0.7500
	2A	0.0013	0.7487	0.7406	—	0.7162	0.7118	0.6892	2B	0.696	0.707	0.7175	0.7232	0.7500
$\frac{3}{4}$ -20 UNEF	3A	0.0000	0.7500	0.7419	—	0.7175	0.7142	0.6905	3B	0.6960	0.7037	0.7175	0.7218	0.7500
	2A	0.0012	0.7488	0.7416	—	0.7217	0.7176	0.6992	2B	0.705	0.715	0.7229	0.7282	0.7500
$\frac{3}{4}$ -24 UNS	2A	0.0012	0.7488	0.7421	—	0.7247	0.7208	0.7047	2B	0.710	0.719	0.7259	0.7310	0.7500

Table 3. (Continued) Standard Series and Selected Combinations — Unified Screw Threads

Nominal Size, Threads per Inch, and Series Designation ^a	External ^b							Internal ^b						
	Class	Allow- ance	Major Diameter			Pitch Diameter		UNR Minor Dia., ^c Max (Ref.)	Class	Minor Diameter		Pitch Diameter		Major Diameter
			Max ^d	Min	Min ^e	Max ^d	Min			Min	Max	Min	Max	
$\frac{3}{4}$ -28 UN	2A	0.0012	0.7488	0.7423	—	0.7256	0.7218	0.7062	2B	0.711	0.720	0.7268	0.7318	0.7500
	3A	0.0000	0.7500	0.7435	—	0.7268	0.7239	0.7074	3B	0.7110	0.7176	0.7268	0.7305	0.7500
$\frac{3}{4}$ -32 UN	2A	0.0011	0.7489	0.7429	—	0.7286	0.7250	0.7117	2B	0.716	0.724	0.7297	0.7344	0.7500
	3A	0.0000	0.7500	0.7440	—	0.7297	0.7270	0.7128	3B	0.7160	0.7219	0.7297	0.7333	0.7500
$\frac{1}{2}$ -12 UN	2A	0.0017	0.8108	0.7994	—	0.7567	0.7512	0.7116	2B	0.722	0.740	0.7584	0.7656	0.8125
	3A	0.0000	0.8125	0.8011	—	0.7584	0.7543	0.7133	3B	0.7220	0.7329	0.7584	0.7638	0.8125
$\frac{1}{2}$ -16 UN	2A	0.0015	0.8110	0.8016	—	0.7704	0.7655	0.7365	2B	0.745	0.759	0.7719	0.7782	0.8125
	3A	0.0000	0.8125	0.8031	—	0.7719	0.7683	0.7380	3B	0.7450	0.7533	0.7719	0.7766	0.8125
$\frac{1}{2}$ -20 UNEF	2A	0.0013	0.8112	0.8031	—	0.7787	0.7743	0.7517	2B	0.758	0.770	0.7800	0.7857	0.8125
	3A	0.0000	0.8125	0.8044	—	0.7800	0.7767	0.7530	3B	0.7580	0.7662	0.7800	0.7843	0.8125
$\frac{1}{2}$ -28 UN	2A	0.0012	0.8113	0.8048	—	0.7881	0.7843	0.7687	2B	0.774	0.782	0.7893	0.7943	0.8125
	3A	0.0000	0.8125	0.8060	—	0.7893	0.7864	0.7699	3B	0.7740	0.7801	0.7893	0.7930	0.8125
$\frac{1}{2}$ -32 UN	2A	0.0011	0.8114	0.8054	—	0.7911	0.7875	0.7742	2B	0.779	0.786	0.7922	0.7969	0.8125
	3A	0.0000	0.8125	0.8065	—	0.7922	0.7895	0.7753	3B	0.7790	0.7844	0.7922	0.7958	0.8125
$\frac{7}{8}$ -9 UNC	1A	0.0019	0.8731	0.8523	—	0.8009	0.7914	0.7408	1B	0.755	0.778	0.8028	0.8151	0.8750
	2A	0.0019	0.8731	0.8592	0.8523	0.8009	0.7946	0.7408	2B	0.755	0.778	0.8028	0.8110	0.8750
	3A	0.0000	0.8750	0.8611	—	0.8028	0.7981	0.7427	3B	0.7550	0.7681	0.8028	0.8089	0.8750
$\frac{7}{8}$ -10 UNS	2A	0.0018	0.8732	0.8603	—	0.8082	0.8022	0.7542	2B	0.767	0.788	0.8100	0.8178	0.8750
$\frac{7}{8}$ -12 UN	2A	0.0017	0.8733	0.8619	—	0.8192	0.8137	0.7741	2B	0.785	0.803	0.8209	0.8281	0.8750
	3A	0.0000	0.8750	0.8636	—	0.8209	0.8168	0.7758	3B	0.7850	0.7948	0.8209	0.8263	0.8750
$\frac{7}{8}$ -14 UNF	1A	0.0016	0.8734	0.8579	—	0.8270	0.8189	0.7884	1B	0.798	0.814	0.8286	0.8392	0.8750
	2A	0.0016	0.8734	0.8631	—	0.8270	0.8216	0.7884	2B	0.798	0.814	0.8286	0.8356	0.8750
	3A	0.0000	0.8750	0.8647	—	0.8286	0.8245	0.7900	3B	0.7980	0.8068	0.8286	0.8339	0.8750
$\frac{7}{8}$ -16 UN	2A	0.0015	0.8735	0.8641	—	0.8329	0.8280	0.7900	2B	0.807	0.821	0.8344	0.8407	0.8750
	3A	0.0000	0.8750	0.8656	—	0.8344	0.8308	0.8005	3B	0.8070	0.8158	0.8344	0.8391	0.8750
$\frac{7}{8}$ -18 UNS	2A	0.0014	0.8736	0.8649	—	0.8375	0.8329	0.8075	2B	0.815	0.828	0.8389	0.8449	0.8750
$\frac{7}{8}$ -20 UNEF	2A	0.0013	0.8737	0.8656	—	0.8412	0.8368	0.8142	2B	0.821	0.832	0.8425	0.8482	0.8750
	3A	0.0000	0.8750	0.8669	—	0.8425	0.8392	0.8155	3B	0.8210	0.8287	0.8425	0.8468	0.8750

Table 3. (Continued) Standard Series and Selected Combinations — Unified Screw Threads

Nominal Size, Threads per Inch, and Series Designation ^a	External ^b							Internal ^b						
	Class	Allow- ance	Major Diameter			Pitch Diameter		UNR Minor Dia., ^c Max (Ref.)	Class	Minor Diameter		Pitch Diameter		Major Diameter
			Max ^d	Min	Min ^e	Max ^d	Min			Min	Max	Min	Max	
$\frac{3}{8}$ -24 UNS	2A	0.0012	0.8738	0.8666	—	0.8467	0.8426	0.8242	2B	0.830	0.840	0.8479	0.8532	0.8750
$\frac{3}{8}$ -27 UNS	2A	0.0012	0.8738	0.8671	—	0.8497	0.8458	0.8297	2B	0.835	0.844	0.8509	0.8560	0.8750
$\frac{7}{8}$ -28 UN	2A	0.0012	0.8738	0.8673	—	0.8506	0.8468	0.8312	2B	0.836	0.845	0.8518	0.8568	0.8750
	3A	0.0000	0.8750	0.8685	—	0.8518	0.8489	0.8324	3B	0.8360	0.8426	0.8518	0.8555	0.8750
$\frac{7}{8}$ -32 UN	2A	0.0011	0.8739	0.8679	—	0.8536	0.8500	0.8367	2B	0.841	0.849	0.8547	0.8594	0.8750
	3A	0.0000	0.8750	0.8690	—	0.8547	0.8520	0.8378	3B	0.8410	0.8469	0.8547	0.8583	0.8750
$\frac{15}{16}$ -12 UN	2A	0.0017	0.9358	0.9244	—	0.8817	0.8760	0.8366	2B	0.847	0.865	0.8834	0.8908	0.9375
	3A	0.0000	0.9375	0.9261	—	0.8834	0.8793	0.8383	3B	0.8470	0.8575	0.8834	0.8889	0.9375
$\frac{15}{16}$ -16 UN	2A	0.0015	0.9360	0.9266	—	0.8954	0.8904	0.8615	2B	0.870	0.884	0.8969	0.9034	0.9375
	3A	0.0000	0.9375	0.9281	—	0.8969	0.8932	0.8630	3B	0.8700	0.8783	0.8969	0.9018	0.9375
$\frac{15}{16}$ -20 UNEF	2A	0.0014	0.9361	0.9280	—	0.9036	0.8991	0.8766	2B	0.883	0.895	0.9050	0.9109	0.9375
	3A	0.0000	0.9375	0.9294	—	0.9050	0.9016	0.8780	3B	0.8830	0.8912	0.9050	0.9094	0.9375
$\frac{15}{16}$ -28 UN	2A	0.0012	0.9363	0.9298	—	0.9131	0.9091	0.8937	2B	0.899	0.907	0.9143	0.9195	0.9375
	3A	0.0000	0.9375	0.9310	—	0.9143	0.9113	0.8949	3B	0.8990	0.9051	0.9143	0.9182	0.9375
$\frac{15}{16}$ -32 UN	2A	0.0011	0.9364	0.9304	—	0.9161	0.9123	0.8992	2B	0.904	0.911	0.9172	0.9221	0.9375
	3A	0.0000	0.9375	0.9315	—	0.9172	0.9144	0.9003	3B	0.9040	0.9094	0.9172	0.9209	0.9375
1-8 UNC	1A	0.0020	0.9980	0.9755	—	0.9168	0.9067	0.8492	1B	0.865	0.890	0.9188	0.9320	1.0000
	2A	0.0020	0.9980	0.9830	0.9755	0.9168	0.9100	0.8492	2B	0.865	0.890	0.9188	0.9276	1.0000
	3A	0.0000	1.0000	0.9850	—	0.9188	0.9137	0.8512	3B	0.8650	0.8797	0.9188	0.9254	1.0000
1-10 UNS	2A	0.0018	0.9982	0.9853	—	0.9332	0.9270	0.8792	2B	0.892	0.913	0.9350	0.9430	1.0000
1-12 UNF	1A	0.0018	0.9982	0.9810	—	0.9441	0.9353	0.8990	1B	0.910	0.928	0.9459	0.9573	1.0000
	2A	0.0018	0.9982	0.9868	—	0.9441	0.9382	0.8990	2B	0.910	0.928	0.9459	0.9535	1.0000
	3A	0.0000	1.0000	0.9886	—	0.9459	0.9415	0.9008	3B	0.9100	0.9198	0.9459	0.9516	1.0000
1-14 UNS ^f	1A	0.0017	0.9983	0.9828	—	0.9519	0.9435	0.9132	1B	0.923	0.938	0.9536	0.9645	1.0000
	2A	0.0017	0.9983	0.9880	—	0.9519	0.9463	0.9132	2B	0.923	0.938	0.9536	0.9609	1.0000
	3A	0.0000	1.0000	0.9897	—	0.9536	0.9494	0.9149	3B	0.9230	0.9315	0.9536	0.9590	1.0000
1-16 UN	2A	0.0015	0.9985	0.9891	—	0.9579	0.9529	0.9240	2B	0.932	0.946	0.9594	0.9659	1.0000
	3A	0.0000	1.0000	0.9906	—	0.9594	0.9557	0.9255	3B	0.9320	0.9408	0.9594	0.9643	1.0000
1-18 UNS	2A	0.0014	0.9986	0.9899	—	0.9625	0.9578	0.9325	2B	0.940	0.953	0.9639	0.9701	1.0000

Table 3. (Continued) Standard Series and Selected Combinations — Unified Screw Threads

Nominal Size, Threads per Inch, and Series Designation ^a	External ^b							Internal ^b						
	Class	Allow- ance	Major Diameter			Pitch Diameter		UNR Minor Dia., ^c Max (Ref.)	Class	Minor Diameter		Pitch Diameter		Major Diameter
			Max ^d	Min	Min ^e	Max ^d	Min			Min	Max	Min	Max	
1-20 UNEF	2A	0.0014	0.9986	0.9905	—	0.9661	0.9616	0.9391	2B	0.946	0.957	0.9675	0.9734	1.0000
	3A	0.0000	1.0000	0.9919	—	0.9675	0.9641	0.9405	3B	0.9460	0.9537	0.9675	0.9719	1.0000
1-24 UNS	2A	0.0013	0.9987	0.9915	—	0.9716	0.9674	0.9491	2B	0.955	0.965	0.9729	0.9784	1.0000
1-27 UNS	2A	0.0012	0.9988	0.9921	—	0.9747	0.9707	0.9547	2B	0.960	0.969	0.9759	0.9811	1.0000
1-28 UN	2A	0.0012	0.9988	0.9923	—	0.9756	0.9716	0.9562	2B	0.961	0.970	0.9768	0.9820	1.0000
	3A	0.0000	1.0000	0.9935	—	0.9768	0.9738	0.9574	3B	0.9610	0.9676	0.9768	0.9807	1.0000
1-32 UN	2A	0.0011	0.9989	0.9929	—	0.9786	0.9748	0.9617	2B	0.966	0.974	0.9797	0.9846	1.0000
	3A	0.0000	1.0000	0.9940	—	0.9797	0.9769	0.9628	3B	0.9660	0.9719	0.9797	0.9834	1.0000
1 $\frac{1}{16}$ -8 UN	2A	0.0020	1.0605	1.0455	—	0.9793	0.9725	0.9117	2B	0.927	0.952	0.9813	0.9902	1.0625
	3A	0.0000	1.0625	1.0475	—	0.9813	0.9762	0.9137	3B	0.9270	0.9422	0.9813	0.9880	1.0625
1 $\frac{1}{16}$ -12 UN	2A	0.0017	1.0608	1.0494	—	1.0067	1.0010	0.9616	2B	0.972	0.990	1.0084	1.0158	1.0625
	3A	0.0000	1.0625	1.0511	—	1.0084	1.0042	0.9633	3B	0.9720	0.9823	1.0084	1.0139	1.0625
1 $\frac{1}{16}$ -16 UN	2A	0.0015	1.0610	1.0516	—	1.0204	1.0154	0.9865	2B	0.995	1.009	1.0219	1.0284	1.0625
	3A	0.0000	1.0625	1.0531	—	1.0219	1.0182	0.9880	3B	0.9950	1.0033	1.0219	1.0268	1.0625
1 $\frac{1}{16}$ -18 UNEF	2A	0.0014	1.0611	1.0524	—	1.0250	1.0203	0.9950	2B	1.002	1.015	1.0264	1.0326	1.0625
	3A	0.0000	1.0625	1.0538	—	1.0264	1.0228	0.9964	3B	1.0020	1.0105	1.0264	1.0310	1.0625
1 $\frac{1}{16}$ -20 UN	2A	0.0014	1.0611	1.0530	—	1.0286	1.0241	1.0016	2B	1.008	1.020	1.0300	1.0359	1.0625
	3A	0.0000	1.0625	1.0544	—	1.0300	1.0266	1.0030	3B	1.0080	1.0162	1.0300	1.0344	1.0625
1 $\frac{1}{16}$ -28 UN	2A	0.0012	1.0613	1.0548	—	1.0381	1.0341	1.0187	2B	1.024	1.032	1.0393	1.0445	1.0625
	3A	0.0000	1.0625	1.0560	—	1.0393	1.0363	1.0199	3B	1.0240	1.0301	1.0393	1.0432	1.0625
1 $\frac{1}{8}$ -7 UNC	1A	0.0022	1.1228	1.0982	—	1.0300	1.0191	0.9527	1B	0.970	0.998	1.0322	1.0463	1.1250
	2A	0.0022	1.1228	1.1064	1.0982	1.0300	1.0228	0.9527	2B	0.970	0.998	1.0322	1.0416	1.1250
	3A	0.0000	1.1250	1.1086	—	1.0322	1.0268	0.9549	3B	0.9700	0.9875	1.0322	1.0393	1.1250
1 $\frac{1}{8}$ -8 UN	2A	0.0021	1.1229	1.1079	1.1004	1.0417	1.0348	0.9741	2B	0.990	1.015	1.0438	1.0528	1.1250
	3A	0.0000	1.1250	1.1100	—	1.0438	1.0386	0.9762	3B	0.9900	1.0047	1.0438	1.0505	1.1250
1 $\frac{1}{8}$ -10 UNS	2A	0.0018	1.1232	1.1103	—	1.0582	1.0520	1.0042	2B	1.017	1.038	1.0600	1.0680	1.1250
1 $\frac{1}{8}$ -12 UNF	1A	0.0018	1.1232	1.1060	—	1.0691	1.0601	1.0240	1B	1.035	1.053	1.0709	1.0826	1.1250
	2A	0.0018	1.1232	1.1118	—	1.0691	1.0631	1.0240	2B	1.035	1.053	1.0709	1.0787	1.1250
	3A	0.0000	1.1250	1.1136	—	1.0709	1.0664	1.0258	3B	1.0350	1.0448	1.0709	1.0768	1.1250

Table 3. (Continued) Standard Series and Selected Combinations — Unified Screw Threads

Nominal Size, Threads per Inch, and Series Designation ^a	External ^b							Internal ^b						
	Class	Allow- ance	Major Diameter			Pitch Diameter		UNR Minor Dia., ^c Max (Ref.)	Class	Minor Diameter		Pitch Diameter		Major Diameter
			Max ^d	Min	Min ^e	Max ^d	Min			Min	Max	Min	Max	
1/8-14 UNS	2A	0.0016	1.1234	1.1131	—	1.0770	1.0717	1.0384	2B	1.048	1.064	1.0786	1.0855	1.1250
1/8-16 UN	2A	0.0015	1.1235	1.1141	—	1.0829	1.0779	1.0490	2B	1.057	1.071	1.0844	1.0909	1.1250
	3A	0.0000	1.1250	1.1156	—	1.0844	1.0807	1.0505	3B	1.0570	1.0658	1.0844	1.0893	1.1250
1/8-18 UNEF	2A	0.0014	1.1236	1.1149	—	1.0875	1.0828	1.0575	2B	1.065	1.078	1.0889	1.0951	1.1250
	3A	0.0000	1.1250	1.1163	—	1.0889	1.0853	1.0589	3B	1.0650	1.0730	1.0889	1.0935	1.1250
1/8-20 UN	2A	0.0014	1.1236	1.1155	—	1.0911	1.0866	1.0641	2B	1.071	1.082	1.0925	1.0984	1.1250
	3A	0.0000	1.1250	1.1169	—	1.0925	1.0891	1.0655	3B	1.0710	1.0787	1.0925	1.0969	1.1250
1/8-24 UNS	2A	0.0013	1.1237	1.1165	—	1.0966	1.0924	1.0742	2B	1.080	1.090	1.0979	1.1034	1.1250
1/8-28 UN	2A	0.0012	1.1238	1.1173	—	1.1006	1.0966	1.0812	2B	1.086	1.095	1.1018	1.1070	1.1250
	3A	0.0000	1.1250	1.1185	—	1.1018	1.0988	1.0824	3B	1.0860	1.0926	1.1018	1.1057	1.1250
3/16-8 UN	2A	0.0021	1.1854	1.1704	—	1.1042	1.0972	1.0366	2B	1.052	1.077	1.1063	1.1154	1.1875
	3A	0.0000	1.1875	1.1725	—	1.1063	1.1011	1.0387	3B	1.0520	1.0672	1.1063	1.1131	1.1875
3/16-12 UN	2A	0.0017	1.1858	1.1744	—	1.1317	1.1259	1.0866	2B	1.097	1.115	1.1334	1.1409	1.1875
	3A	0.0000	1.1875	1.1761	—	1.1334	1.1291	1.0883	3B	1.0970	1.1073	1.1334	1.1390	1.1875
3/16-16 UN	2A	0.0015	1.1860	1.1766	—	1.1454	1.1403	1.1115	2B	1.120	1.134	1.1469	1.1535	1.1875
	3A	0.0000	1.1875	1.1781	—	1.1469	1.1431	1.1130	3B	1.1200	1.1283	1.1469	1.1519	1.1875
3/16-18 UNEF	2A	0.0015	1.1860	1.1773	—	1.1499	1.1450	1.1199	2B	1.127	1.140	1.1514	1.1577	1.1875
	3A	0.0000	1.1875	1.1788	—	1.1514	1.1478	1.1214	3B	1.1270	1.1355	1.1514	1.1561	1.1875
3/16-20 UN	2A	0.0014	1.1861	1.1780	—	1.1536	1.1489	1.1266	2B	1.133	1.145	1.1550	1.1611	1.1875
	3A	0.0000	1.1875	1.1794	—	1.1550	1.1515	1.1280	3B	1.1330	1.1412	1.1550	1.1595	1.1875
3/16-28 UN	2A	0.0012	1.1863	1.1798	—	1.1631	1.1590	1.1437	2B	1.149	1.157	1.1643	1.1696	1.1875
	3A	0.0000	1.1875	1.1810	—	1.1643	1.1612	1.1449	3B	1.1490	1.1551	1.1643	1.1683	1.1875
1/2-7 UNC	1A	0.0022	1.2478	1.2232	—	1.1550	1.1439	1.0777	1B	1.095	1.123	1.1572	1.1716	1.2500
	2A	0.0022	1.2478	1.2314	1.2232	1.1550	1.1476	1.0777	2B	1.095	1.123	1.1572	1.1668	1.2500
	3A	0.0000	1.2500	1.2336	—	1.1572	1.1517	1.0799	3B	1.0950	1.1125	1.1572	1.1644	1.2500
1/2-8 UN	2A	0.0021	1.2479	1.2329	1.2254	1.1667	1.1597	1.0991	2B	1.115	1.140	1.1688	1.1780	1.2500
	3A	0.0000	1.2500	1.2350	—	1.1688	1.1635	1.1012	3B	1.1150	1.1297	1.1688	1.1757	1.2500
1/2-10 UNS	2A	0.0019	1.2481	1.2352	—	1.1831	1.1768	1.1291	2B	1.142	1.163	1.1850	1.1932	1.2500

Table 3. (Continued) Standard Series and Selected Combinations — Unified Screw Threads

Nominal Size, Threads per Inch, and Series Designation ^a	External ^b								Internal ^b					
	Class	Allow- ance	Major Diameter			Pitch Diameter		UNR Minor Dia., ^c Max (Ref.)	Class	Minor Diameter		Pitch Diameter		Major Diameter
			Max ^d	Min	Min ^e	Max ^d	Min			Min	Max	Min	Max	
1/4-12 UNF	1A	0.0018	1.2482	1.2310	—	1.1941	1.1849	1.1490	1B	1.160	1.178	1.1959	1.2079	1.2500
	2A	0.0018	1.2482	1.2368	—	1.1941	1.1879	1.1490	2B	1.160	1.178	1.1959	1.2039	1.2500
	3A	0.0000	1.2500	1.2386	—	1.1959	1.1913	1.1508	3B	1.1600	1.1698	1.1959	1.2019	1.2500
1/4-14 UNS	2A	0.0016	1.2484	1.2381	—	1.2020	1.1966	1.1634	2B	1.173	1.188	1.2036	1.2106	1.2500
1/4-16 UN	2A	0.0015	1.2485	1.2391	—	1.2079	1.2028	1.1740	2B	1.182	1.196	1.2094	1.2160	1.2500
	3A	0.0000	1.2500	1.2406	—	1.2094	1.2056	1.1755	3B	1.1820	1.1908	1.2094	1.2144	1.2500
1/4-18 UNEF	2A	0.0015	1.2485	1.2398	—	1.2124	1.2075	1.1824	2B	1.190	1.203	1.2139	1.2202	1.2500
	3A	0.0000	1.2500	1.2413	—	1.2139	1.2103	1.1839	3B	1.1900	1.1980	1.2139	1.2186	1.2500
1/4-20 UN	2A	0.0014	1.2486	1.2405	—	1.2161	1.2114	1.1891	2B	1.196	1.207	1.2175	1.2236	1.2500
	3A	0.0000	1.2500	1.2419	—	1.2175	1.2140	1.1905	3B	1.1960	1.2037	1.2175	1.2220	1.2500
1/4-24 UNS	2A	0.0013	1.2487	1.2415	—	1.2216	1.2173	1.1991	2B	1.205	1.215	1.2229	1.2285	1.2500
1/4-28 UN	2A	0.0012	1.2488	1.2423	—	1.2256	1.2215	1.2062	2B	1.211	1.220	1.2268	1.2321	1.2500
	3A	0.0000	1.2500	1.2435	—	1.2268	1.2237	1.2074	3B	1.2110	1.2176	1.2268	1.2308	1.2500
5/16-8 UN	2A	0.0021	1.3104	1.2954	—	1.2292	1.2221	1.1616	2B	1.177	1.202	1.2313	1.2405	1.3125
	3A	0.0000	1.3125	1.2975	—	1.2313	1.2260	1.1637	3B	1.1770	1.1922	1.2313	1.2382	1.3125
5/16-12 UN	2A	0.0017	1.3108	1.2994	—	1.2567	1.2509	1.2116	2B	1.222	1.240	1.2584	1.2659	1.3125
	3A	0.0000	1.3125	1.3011	—	1.2584	1.2541	1.2133	3B	1.2220	1.2323	1.2584	1.2640	1.3125
5/16-16 UN	2A	0.0015	1.3110	1.3016	—	1.2704	1.2653	1.2365	2B	1.245	1.259	1.2719	1.2785	1.3125
	3A	0.0000	1.3125	1.3031	—	1.2719	1.2681	1.2380	3B	1.2450	1.2533	1.2719	1.2769	1.3125
5/16-18 UNEF	2A	0.0015	1.3110	1.3023	—	1.2749	1.2700	1.2449	2B	1.252	1.265	1.2764	1.2827	1.3125
	3A	0.0000	1.3125	1.3038	—	1.2764	1.2728	1.2464	3B	1.2520	1.2605	1.2764	1.2811	1.3125
5/16-20 UN	2A	0.0014	1.3111	1.3030	—	1.2786	1.2739	1.2516	2B	1.258	1.270	1.2800	1.2861	1.3125
	3A	0.0000	1.3125	1.3044	—	1.2800	1.2765	1.2530	3B	1.2580	1.2662	1.2800	1.2845	1.3125
5/16-28 UN	2A	0.0012	1.3113	1.3048	—	1.2881	1.2840	1.2687	2B	1.274	1.282	1.2893	1.2946	1.3125
	3A	0.0000	1.3125	1.3060	—	1.2893	1.2862	1.2699	3B	1.2740	1.2801	1.2893	1.2933	1.3125
3/8-6 UNC	1A	0.0024	1.3726	1.3453	—	1.2643	1.2523	1.1742	1B	1.195	1.225	1.2667	1.2822	1.3750
	2A	0.0024	1.3726	1.3544	1.3453	1.2643	1.2563	1.1742	2B	1.195	1.225	1.2667	1.2771	1.3750
	3A	0.0000	1.3750	1.3568	—	1.2667	1.2607	1.1766	3B	1.1950	1.2146	1.2667	1.2745	1.3750

Table 3. (Continued) Standard Series and Selected Combinations — Unified Screw Threads

Nominal Size, Threads per Inch, and Series Designation ^a	External ^b							Internal ^b						
	Class	Allow- ance	Major Diameter			Pitch Diameter		UNR Minor Dia., ^c Max (Ref.)	Class	Minor Diameter		Pitch Diameter		Major Diameter
			Max ^d	Min	Min ^e	Max ^d	Min			Min	Max	Min	Max	
1 $\frac{3}{8}$ -8 UN	2A	0.0022	1.3728	1.3578	1.3503	1.2916	1.2844	1.2240	2B	1.240	1.265	1.2938	1.3031	1.3750
	3A	0.0000	1.3750	1.3600	—	1.2938	1.2884	1.2262	3B	1.2400	1.2547	1.2938	1.3008	1.3750
1 $\frac{3}{8}$ -10 UNS	2A	0.0019	1.3731	1.3602	—	1.3081	1.3018	1.2541	2B	1.267	1.288	1.3100	1.3182	1.3750
1 $\frac{3}{8}$ -12 UNF	1A	0.0019	1.3731	1.3559	—	1.3190	1.3096	1.2739	1B	1.285	1.303	1.3209	1.3332	1.3750
	2A	0.0019	1.3731	1.3617	—	1.3190	1.3127	1.2739	2B	1.285	1.303	1.3209	1.3291	1.3750
	3A	0.0000	1.3750	1.3636	—	1.3209	1.3162	1.2758	3B	1.2850	1.2948	1.3209	1.3270	1.3750
1 $\frac{3}{8}$ -14 UNS	2A	0.0016	1.3734	1.3631	—	1.3270	1.3216	1.2884	2B	1.298	1.314	1.3286	1.3356	1.3750
1 $\frac{3}{8}$ -16 UN	2A	0.0015	1.3735	1.3641	—	1.3329	1.3278	1.2990	2B	1.307	1.321	1.3344	1.3410	1.3750
	3A	0.0000	1.3750	1.3656	—	1.3344	1.3306	1.3005	3B	1.3070	1.3158	1.3344	1.3394	1.3750
	2A	0.0015	1.3735	1.3648	—	1.3374	1.3325	1.3074	2B	1.315	1.328	1.3389	1.3452	1.3750
1 $\frac{3}{8}$ -18 UNEF	3A	0.0000	1.3750	1.3663	—	1.3389	1.3353	1.3089	3B	1.3150	1.3230	1.3389	1.3436	1.3750
1 $\frac{3}{8}$ -20 UN	2A	0.0014	1.3736	1.3655	—	1.3411	1.3364	1.3141	2B	1.321	1.332	1.3425	1.3486	1.3750
	3A	0.0000	1.3750	1.3669	—	1.3425	1.3390	1.3155	3B	1.3210	1.3287	1.3425	1.3470	1.3750
1 $\frac{3}{8}$ -24 UNS	2A	0.0013	1.3737	1.3665	—	1.3466	1.3423	1.3241	2B	1.330	1.340	1.3479	1.3535	1.3750
1 $\frac{3}{8}$ -28 UN	2A	0.0012	1.3738	1.3673	—	1.3506	1.3465	1.3312	2B	1.336	1.345	1.3518	1.3571	1.3750
	3A	0.0000	1.3750	1.3685	—	1.3518	1.3487	1.3324	3B	1.3360	1.3426	1.3518	1.3558	1.3750
1 $\frac{7}{16}$ -6 UN	2A	0.0024	1.4351	1.4169	—	1.3268	1.3188	1.2367	2B	1.257	1.288	1.3292	1.3396	1.4375
	3A	0.0000	1.4375	1.4193	—	1.3292	1.3232	1.2391	3B	1.2570	1.2771	1.3292	1.3370	1.4375
1 $\frac{7}{16}$ -8 UN	2A	0.0022	1.4353	1.4203	—	1.3541	1.3469	1.2865	2B	1.302	1.327	1.3563	1.3657	1.4375
	3A	0.0000	1.4375	1.4225	—	1.3563	1.3509	1.2887	3B	1.3020	1.3172	1.3563	1.3634	1.4375
1 $\frac{7}{16}$ -12 UN	2A	0.0018	1.4357	1.4243	—	1.3816	1.3757	1.3365	2B	1.347	1.365	1.3834	1.3910	1.4375
	3A	0.0000	1.4375	1.4261	—	1.3834	1.3790	1.3383	3B	1.3470	1.3573	1.3834	1.3891	1.4375
1 $\frac{7}{16}$ -16 UN	2A	0.0016	1.4359	1.4265	—	1.3953	1.3901	1.3614	2B	1.370	1.384	1.3969	1.4037	1.4375
	3A	0.0000	1.4375	1.4281	—	1.3969	1.3930	1.3630	3B	1.3700	1.3783	1.3969	1.4020	1.4375
1 $\frac{7}{16}$ -18 UNEF	2A	0.0015	1.4360	1.4273	—	1.3999	1.3949	1.3699	2B	1.377	1.390	1.4014	1.4079	1.4375
	3A	0.0000	1.4375	1.4288	—	1.4014	1.3977	1.3714	3B	1.3770	1.3855	1.4014	1.4062	1.4375
1 $\frac{7}{16}$ -20 UN	2A	0.0014	1.4361	1.4280	—	1.4036	1.3988	1.3766	2B	1.383	1.395	1.4050	1.4112	1.4375
	3A	0.0000	1.4375	1.4294	—	1.4050	1.4014	1.3780	3B	1.3830	1.3912	1.4050	1.4096	1.4375

Table 3. (Continued) Standard Series and Selected Combinations — Unified Screw Threads

Nominal Size, Threads per Inch, and Series Designation ^a	External ^b							Internal ^b						
	Class	Allow- ance	Major Diameter			Pitch Diameter		UNR Minor Dia., ^c Max (Ref.)	Class	Minor Diameter		Pitch Diameter		Major Diameter
			Max ^d	Min	Min ^e	Max ^d	Min			Min	Max	Min	Max	
1 $\frac{1}{16}$ -28 UN	2A	0.0013	1.4362	1.4297	—	1.4130	1.4088	1.3936	2B	1.399	1.407	1.4143	1.4198	1.4375
	3A	0.0000	1.4375	1.4310	—	1.4143	1.4112	1.3949	3B	1.3990	1.4051	1.4143	1.4184	1.4375
1 $\frac{1}{2}$ -6 UNC	1A	0.0024	1.4976	1.4703	—	1.3893	1.3772	1.2992	1B	1.320	1.350	1.3917	1.4075	1.5000
	2A	0.0024	1.4976	1.4794	1.4703	1.3893	1.3812	1.2992	2B	1.320	1.350	1.3917	1.4022	1.5000
	3A	0.0000	1.5000	1.4818	—	1.3917	1.3856	1.3016	3B	1.3200	1.3396	1.3917	1.3996	1.5000
1 $\frac{1}{2}$ -8 UN	2A	0.0022	1.4978	1.4828	1.4753	1.4166	1.4093	1.3490	2B	1.365	1.390	1.4188	1.4283	1.5000
	3A	0.0000	1.5000	1.4850	—	1.4188	1.4133	1.3512	3B	1.3650	1.3797	1.4188	1.4259	1.5000
1 $\frac{1}{2}$ -10 UNS	2A	0.0019	1.4981	1.4852	—	1.4331	1.4267	1.3791	2B	1.392	1.413	1.4350	1.4433	1.5000
1 $\frac{1}{2}$ -12 UNF	1A	0.0019	1.4981	1.4809	—	1.4440	1.4344	1.3989	1B	1.410	1.428	1.4459	1.4584	1.5000
	2A	0.0019	1.4981	1.4867	—	1.4440	1.4376	1.3989	2B	1.410	1.428	1.4459	1.4542	1.5000
	3A	0.0000	1.5000	1.4886	—	1.4459	1.4411	1.4008	3B	1.4100	1.4198	1.4459	1.4522	1.5000
1 $\frac{1}{2}$ -14 UNS	2A	0.0017	1.4983	1.4880	—	1.4519	1.4464	1.4133	2B	1.423	1.438	1.4536	1.4608	1.5000
1 $\frac{1}{2}$ -16 UN	2A	0.0016	1.4984	1.4890	—	1.4578	1.4526	1.4239	2B	1.432	1.446	1.4594	1.4662	1.5000
	3A	0.0000	1.5000	1.4906	—	1.4594	1.4555	1.4255	3B	1.4320	1.4408	1.4594	1.4645	1.5000
	2A	0.0015	1.4985	1.4898	—	1.4624	1.4574	1.4324	2B	1.440	1.452	1.4639	1.4704	1.5000
1 $\frac{1}{2}$ -18 UNEF	3A	0.0000	1.5000	1.4913	—	1.4639	1.4602	1.4339	3B	1.4400	1.4480	1.4639	1.4687	1.5000
	2A	0.0014	1.4986	1.4905	—	1.4661	1.4613	1.4391	2B	1.446	1.457	1.4675	1.4737	1.5000
1 $\frac{1}{2}$ -20 UN	3A	0.0000	1.5000	1.4919	—	1.4675	1.4639	1.4405	3B	1.4460	1.4537	1.4675	1.4721	1.5000
	2A	0.0013	1.4987	1.4915	—	1.4716	1.4672	1.4491	2B	1.455	1.465	1.4729	1.4787	1.5000
1 $\frac{1}{2}$ -24 UNS	2A	0.0013	1.4987	1.4922	—	1.4755	1.4713	1.4561	2B	1.461	1.470	1.4768	1.4823	1.5000
1 $\frac{1}{2}$ -28 UN	3A	0.0000	1.5000	1.4935	—	1.4768	1.4737	1.4574	3B	1.4610	1.4676	1.4768	1.4809	1.5000
	2A	0.0024	1.5601	1.5419	—	1.4518	1.4436	1.3617	2B	1.382	1.413	1.4542	1.4648	1.5625
1 $\frac{9}{16}$ -6 UN	3A	0.0000	1.5625	1.5443	—	1.4542	1.4481	1.3641	3B	1.3820	1.4021	1.4542	1.4622	1.5625
	2A	0.0022	1.5603	1.5453	—	1.4791	1.4717	1.4115	2B	1.427	1.452	1.4813	1.4909	1.5625
	3A	0.0000	1.5625	1.5475	—	1.4813	1.4758	1.4137	3B	1.4270	1.4422	1.4813	1.4885	1.5625
1 $\frac{9}{16}$ -12 UN	2A	0.0018	1.5607	1.5493	—	1.5066	1.5007	1.4615	2B	1.472	1.490	1.5084	1.5160	1.5625
	3A	0.0000	1.5625	1.5511	—	1.5084	1.5040	1.4633	3B	1.4720	1.4823	1.5084	1.5141	1.5625

Table 3. (Continued) Standard Series and Selected Combinations — Unified Screw Threads

Nominal Size, Threads per Inch, and Series Designation ^a	External ^b							Internal ^b						
	Class	Allow- ance	Major Diameter			Pitch Diameter		UNR Minor Dia., ^c Max (Ref.)	Class	Minor Diameter		Pitch Diameter		Major Diameter
			Max ^d	Min	Min ^e	Max ^d	Min			Min	Max	Min	Max	
1 $\frac{1}{16}$ -16 UN	2A	0.0016	1.5609	1.5515	—	1.5203	1.5151	1.4864	2B	1.495	1.509	1.5219	1.5287	1.5625
	3A	0.0000	1.5625	1.5531	—	1.5219	1.5180	1.4880	3B	1.4950	1.5033	1.5219	1.5270	1.5625
1 $\frac{1}{16}$ -18 UNEF	2A	0.0015	1.5610	1.5523	—	1.5249	1.5199	1.4949	2B	1.502	1.515	1.5264	1.5329	1.5625
	3A	0.0000	1.5625	1.5538	—	1.5264	1.5227	1.4964	3B	1.5020	1.5105	1.5264	1.5312	1.5625
1 $\frac{1}{16}$ -20 UN	2A	0.0014	1.5611	1.5530	—	1.5286	1.5238	1.5016	2B	1.508	1.520	1.5300	1.5362	1.5625
	3A	0.0000	1.5625	1.5544	—	1.5300	1.5264	1.5030	3B	1.5080	1.5162	1.5300	1.5346	1.5625
1 $\frac{5}{8}$ -6 UN	2A	0.0025	1.6225	1.6043	—	1.5142	1.5060	1.4246	2B	1.445	1.475	1.5167	1.5274	1.6250
	3A	0.0000	1.6250	1.6068	—	1.5167	1.5105	1.4271	3B	1.4450	1.4646	1.5167	1.5247	1.6250
1 $\frac{5}{8}$ -8 UN	2A	0.0022	1.6228	1.6078	1.6003	1.5416	1.5342	1.4784	2B	1.490	1.515	1.5438	1.5535	1.6250
	3A	0.0000	1.6250	1.6100	—	1.5438	1.5382	1.4806	3B	1.4900	1.5047	1.5438	1.5510	1.6250
1 $\frac{5}{8}$ -10 UNS	2A	0.0019	1.6231	1.6102	—	1.5581	1.5517	1.5041	2B	1.517	1.538	1.5600	1.5683	1.6250
	2A	0.0018	1.6232	1.6118	—	1.5691	1.5632	1.5240	2B	1.535	1.553	1.5709	1.5785	1.6250
1 $\frac{5}{8}$ -12 UN	3A	0.0000	1.6250	1.6136	—	1.5709	1.5665	1.5258	3B	1.5350	1.5448	1.5709	1.5766	1.6250
	2A	0.0017	1.6233	1.6130	—	1.5769	1.5714	1.5383	2B	1.548	1.564	1.5786	1.5858	1.6250
1 $\frac{5}{8}$ -16 UN	2A	0.0016	1.6234	1.6140	—	1.5828	1.5776	1.5489	2B	1.557	1.571	1.5844	1.5912	1.6250
	3A	0.0000	1.6250	1.6156	—	1.5844	1.5805	1.5505	3B	1.5570	1.5658	1.5844	1.5895	1.6250
1 $\frac{5}{8}$ -18 UNEF	2A	0.0015	1.6235	1.6148	—	1.5874	1.5824	1.5574	2B	1.565	1.578	1.5889	1.5954	1.6250
	3A	0.0000	1.6250	1.6163	—	1.5889	1.5852	1.5589	3B	1.5650	1.5730	1.5889	1.5937	1.6250
1 $\frac{5}{8}$ -20 UN	2A	0.0014	1.6236	1.6155	—	1.5911	1.5863	1.5641	2B	1.571	1.582	1.5925	1.5987	1.6250
	3A	0.0000	1.6250	1.6169	—	1.5925	1.5889	1.5655	3B	1.5710	1.5787	1.5925	1.5971	1.6250
1 $\frac{5}{8}$ -24 UNS	2A	0.0013	1.6237	1.6165	—	1.5966	1.5922	1.5741	2B	1.580	1.590	1.5979	1.6037	1.6250
	2A	0.0025	1.6850	1.6668	—	1.5767	1.5684	1.4866	2B	1.507	1.538	1.5792	1.5900	1.6875
1 $\frac{11}{16}$ -6 UN	3A	0.0000	1.6875	1.6693	—	1.5792	1.5730	1.4891	3B	1.5070	1.5271	1.5792	1.5873	1.6875
	2A	0.0022	1.6853	1.6703	—	1.6041	1.5966	1.5365	2B	1.552	1.577	1.6063	1.6160	1.6875
1 $\frac{11}{16}$ -8 UN	3A	0.0000	1.6875	1.6725	—	1.6063	1.6007	1.5387	3B	1.5520	1.5672	1.6063	1.6136	1.6875
	2A	0.0018	1.6857	1.6743	—	1.6316	1.6256	1.5865	2B	1.597	1.615	1.6334	1.6412	1.6875
1 $\frac{11}{16}$ -12 UN	3A	0.0000	1.6875	1.6761	—	1.6334	1.6289	1.5883	3B	1.5970	1.6073	1.6334	1.6392	1.6875

Table 3. (Continued) Standard Series and Selected Combinations — Unified Screw Threads

Nominal Size, Threads per Inch, and Series Designation ^a	External ^b							Internal ^b						
	Class	Allow- ance	Major Diameter			Pitch Diameter		UNR Minor Dia., ^c Max (Ref.)	Class	Minor Diameter		Pitch Diameter		Major Diameter
			Max ^d	Min	Min ^e	Max ^d	Min			Min	Max	Min	Max	
1 ¹ / ₁₆ -16 UN	2A	0.0016	1.6859	1.6765	—	1.6453	1.6400	1.6114	2B	1.620	1.634	1.6469	1.6538	1.6875
	3A	0.0000	1.6875	1.6781	—	1.6469	1.6429	1.6130	3B	1.6200	1.6283	1.6469	1.6521	1.6875
1 ¹ / ₁₆ -18 UNEF	2A	0.0015	1.6860	1.6773	—	1.6499	1.6448	1.6199	2B	1.627	1.640	1.6514	1.6580	1.6875
	3A	0.0000	1.6875	1.6788	—	1.6514	1.6476	1.6214	3B	1.6270	1.6355	1.6514	1.6563	1.6875
1 ¹ / ₁₆ -20 UN	2A	0.0015	1.6860	1.6779	—	1.6535	1.6487	1.6265	2B	1.633	1.645	1.6550	1.6613	1.6875
	3A	0.0000	1.6875	1.6794	—	1.6550	1.6514	1.6280	3B	1.6330	1.6412	1.6550	1.6597	1.6875
1 ³ / ₄ -5 UNC	1A	0.0027	1.7473	1.7165	—	1.6174	1.6040	1.5092	1B	1.534	1.568	1.6201	1.6375	1.7500
	2A	0.0027	1.7473	1.7268	1.7165	1.6174	1.6085	1.5092	2B	1.534	1.568	1.6201	1.6317	1.7500
	3A	0.0000	1.7500	1.7295	—	1.6201	1.6134	1.5119	3B	1.5340	1.5575	1.6201	1.6288	1.7500
1 ³ / ₄ -6 UN	2A	0.0025	1.7475	1.7293	—	1.6392	1.6309	1.5491	2B	1.570	1.600	1.6417	1.6525	1.7500
	3A	0.0000	1.7500	1.7318	—	1.6417	1.6354	1.5516	3B	1.5700	1.5896	1.6417	1.6498	1.7500
1 ³ / ₄ -8 UN	2A	0.0023	1.7477	1.7327	1.7252	1.6665	1.6590	1.5989	2B	1.615	1.640	1.6688	1.6786	1.7500
	3A	0.0000	1.7500	1.7350	—	1.6688	1.6632	1.6012	3B	1.6150	1.6297	1.6688	1.6762	1.7500
1 ³ / ₄ -10 UNS	2A	0.0019	1.7481	1.7352	—	1.6831	1.6766	1.6291	2B	1.642	1.663	1.6850	1.6934	1.7500
1 ³ / ₄ -12 UN	2A	0.0018	1.7482	1.7368	—	1.6941	1.6881	1.6490	2B	1.660	1.678	1.6959	1.7037	1.7500
	3A	0.0000	1.7500	1.7386	—	1.6959	1.6914	1.6508	3B	1.6600	1.6698	1.6959	1.7017	1.7500
1 ³ / ₄ -14 UNS	2A	0.0017	1.7483	1.7380	—	1.7019	1.6963	1.6632	2B	1.673	1.688	1.7036	1.7109	1.7500
1 ³ / ₄ -16 UN	2A	0.0016	1.7484	1.7390	—	1.7078	1.7025	1.6739	2B	1.682	1.696	1.7094	1.7163	1.7500
	3A	0.0000	1.7500	1.7406	—	1.7094	1.7054	1.6755	3B	1.6820	1.6908	1.7094	1.7146	1.7500
1 ³ / ₄ -18 UNS	2A	0.0015	1.7485	1.7398	—	1.7124	1.7073	1.6824	2B	1.690	1.703	1.7139	1.7205	1.7500
1 ³ / ₄ -20 UN	2A	0.0015	1.7485	1.7404	—	1.7160	1.7112	1.6890	2B	1.696	1.707	1.7175	1.7238	1.7500
	3A	0.0000	1.7500	1.7419	—	1.7175	1.7139	1.6905	3B	1.6960	1.7037	1.7175	1.7222	1.7500
1 ¹³ / ₁₆ -6 UN	2A	0.0025	1.8100	1.7918	—	1.7017	1.6933	1.6116	2B	1.632	1.663	1.7042	1.7151	1.8125
	3A	0.0000	1.8125	1.7943	—	1.7042	1.6979	1.6141	3B	1.6320	1.6521	1.7042	1.7124	1.8125
1 ¹³ / ₁₆ -8 UN	2A	0.0023	1.8102	1.7952	—	1.7290	1.7214	1.6614	2B	1.677	1.702	1.7313	1.7412	1.8125
	3A	0.0000	1.8125	1.7975	—	1.7313	1.7256	1.6637	3B	1.6770	1.6922	1.7313	1.7387	1.8125
1 ¹³ / ₁₆ -12 UN	2A	0.0018	1.8107	1.7993	—	1.7566	1.7506	1.7115	2B	1.722	1.740	1.7584	1.7662	1.8125
	3A	0.0000	1.8125	1.8011	—	1.7584	1.7539	1.7133	3B	1.7220	1.7323	1.7584	1.7642	1.8125

Table 3. (Continued) Standard Series and Selected Combinations — Unified Screw Threads

Nominal Size, Threads per Inch, and Series Designation ^a	External ^b							Internal ^b						
	Class	Allow- ance	Major Diameter			Pitch Diameter		UNR Minor Dia., ^c Max (Ref.)	Class	Minor Diameter		Pitch Diameter		Major Diameter
			Max ^d	Min	Min ^e	Max ^d	Min			Min	Max	Min	Max	
1 $\frac{3}{16}$ –16 UN	2A	0.0016	1.8109	1.8015	—	1.7703	1.7650	1.7364	2B	1.745	1.759	1.7719	1.7788	1.8125
	3A	0.0000	1.8125	1.8031	—	1.7719	1.7679	1.7380	3B	1.7450	1.7533	1.7719	1.7771	1.8125
1 $\frac{3}{16}$ –20 UN	2A	0.0015	1.8110	1.8029	—	1.7785	1.7737	1.7515	2B	1.758	1.770	1.7800	1.7863	1.8125
	3A	0.0000	1.8125	1.8044	—	1.7800	1.7764	1.7530	3B	1.7580	1.7662	1.7800	1.7847	1.8125
1 $\frac{7}{8}$ –6 UN	2A	0.0025	1.8725	1.8543	—	1.7642	1.7558	1.6741	2B	1.695	1.725	1.7667	1.7777	1.8750
	3A	0.0000	1.8750	1.8568	—	1.7667	1.7604	1.6766	3B	1.6950	1.7146	1.7667	1.7749	1.8750
1 $\frac{7}{8}$ –8 UN	2A	0.0023	1.8727	1.8577	1.8502	1.7915	1.7838	1.7239	2B	1.740	1.765	1.7938	1.8038	1.8750
	3A	0.0000	1.8750	1.8600	—	1.7938	1.7881	1.7262	3B	1.7400	1.7547	1.7938	1.8013	1.8750
1 $\frac{7}{8}$ –10 UNS	2A	0.0019	1.8731	1.8602	—	1.8081	1.8016	1.7541	2B	1.767	1.788	1.8100	1.8184	1.8750
	3A	0.0000	1.8732	1.8618	—	1.8191	1.8131	1.7740	2B	1.785	1.803	1.8209	1.8287	1.8750
1 $\frac{7}{8}$ –12 UN	2A	0.0018	1.8732	1.8618	—	1.8209	1.8164	1.7758	3B	1.7850	1.7948	1.8209	1.8267	1.8750
	3A	0.0000	1.8733	1.8630	—	1.8269	1.8213	1.7883	2B	1.798	1.814	1.8286	1.8359	1.8750
1 $\frac{7}{8}$ –14 UNS	2A	0.0017	1.8734	1.8640	—	1.8328	1.8275	1.7989	2B	1.807	1.821	1.8344	1.8413	1.8750
	3A	0.0000	1.8750	1.8656	—	1.8344	1.8304	1.8005	3B	1.8070	1.8158	1.8344	1.8396	1.8750
1 $\frac{7}{8}$ –18 UNS	2A	0.0015	1.8735	1.8648	—	1.8374	1.8323	1.8074	2B	1.815	1.828	1.8389	1.8455	1.8750
	3A	0.0000	1.8735	1.8654	—	1.8410	1.8362	1.8140	2B	1.821	1.832	1.8425	1.8488	1.8750
1 $\frac{7}{8}$ –20 UN	2A	0.0000	1.8750	1.8669	—	1.8425	1.8389	1.8155	3B	1.8210	1.8287	1.8425	1.8472	1.8750
	3A	0.0026	1.9349	1.9167	—	1.8266	1.8181	1.7365	2B	1.757	1.788	1.8292	1.8403	1.9375
1 $\frac{5}{16}$ –6 UN	2A	0.0000	1.9375	1.9193	—	1.8292	1.8228	1.7391	3B	1.7570	1.7771	1.8292	1.8375	1.9375
	3A	0.0023	1.9352	1.9202	—	1.8540	1.8463	1.7864	2B	1.802	1.827	1.8563	1.8663	1.9375
1 $\frac{5}{16}$ –8 UN	2A	0.0000	1.9375	1.9225	—	1.8563	1.8505	1.7887	3B	1.8020	1.8172	1.8563	1.8638	1.9375
	3A	0.0018	1.9357	1.9243	—	1.8816	1.8755	1.8365	2B	1.847	1.865	1.8834	1.8913	1.9375
1 $\frac{5}{16}$ –12 UN	2A	0.0000	1.9375	1.9261	—	1.8834	1.8789	1.8383	3B	1.8470	1.8573	1.8834	1.8893	1.9375
	3A	0.0016	1.9359	1.9265	—	1.8953	1.8899	1.8614	2B	1.870	1.884	1.8969	1.9039	1.9375
1 $\frac{5}{16}$ –16 UN	2A	0.0000	1.9375	1.9281	—	1.8969	1.8929	1.8630	3B	1.8700	1.8783	1.8969	1.9021	1.9375
	3A	0.0015	1.9360	1.9279	—	1.9035	1.8986	1.8765	2B	1.883	1.895	1.9050	1.9114	1.9375
1 $\frac{5}{16}$ –20 UN	2A	0.0000	1.9375	1.9294	—	1.9050	1.9013	1.8780	3B	1.8830	1.8912	1.9050	1.9098	1.9375

Table 3. (Continued) Standard Series and Selected Combinations — Unified Screw Threads

Nominal Size, Threads per Inch, and Series Designation ^a	External ^b							Internal ^b						
	Class	Allow- ance	Major Diameter			Pitch Diameter		UNR Minor Dia., ^c Max (Ref.)	Class	Minor Diameter		Pitch Diameter		Major Diameter
			Max ^d	Min	Min ^e	Max ^d	Min			Min	Max	Min	Max	
2-4½ UNC	1A	0.0029	1.9971	1.9641	—	1.8528	1.8385	1.7324	1B	1.759	1.795	1.8557	1.8743	2.0000
	2A	0.0029	1.9971	1.9751	1.9641	1.8528	1.8433	1.7324	2B	1.759	1.795	1.8557	1.8681	2.0000
	3A	0.0000	2.0000	1.9780	—	1.8557	1.8486	1.7353	3B	1.7590	1.7861	1.8557	1.8650	2.0000
2-6 UN	2A	0.0026	1.9974	1.9792	—	1.8891	1.8805	1.7990	2B	1.820	1.850	1.8917	1.9028	2.0000
	3A	0.0000	2.0000	1.9818	—	1.8917	1.8853	1.8016	3B	1.8200	1.8396	1.8917	1.9000	2.0000
2-8 UN	2A	0.0023	1.9977	1.9827	1.9752	1.9165	1.9087	1.8489	2B	1.865	1.890	1.9188	1.9289	2.0000
	3A	0.0000	2.0000	1.9850	—	1.9188	1.9130	1.8512	3B	1.8650	1.8797	1.9188	1.9264	2.0000
2-10 UNS	2A	0.0020	1.9980	1.9851	—	1.9330	1.9265	1.8790	2B	1.892	1.913	1.9350	1.9435	2.0000
2-12 UN	2A	0.0018	1.9982	1.9868	—	1.9441	1.9380	1.8990	2B	1.910	1.928	1.9459	1.9538	2.0000
	3A	0.0000	2.0000	1.9886	—	1.9459	1.9414	1.9008	3B	1.9100	1.9198	1.9459	1.9518	2.0000
2-14 UNS	2A	0.0017	1.9983	1.9880	—	1.9519	1.9462	1.9133	2B	1.923	1.938	1.9536	1.9610	2.0000
2-16 UN	2A	0.0016	1.9984	1.9890	—	1.9578	1.9524	1.9239	2B	1.932	1.946	1.9594	1.9664	2.0000
	3A	0.0000	2.0000	1.9906	—	1.9594	1.9554	1.9255	3B	1.9320	1.9408	1.9594	1.9646	2.0000
2-18 UNS	2A	0.0015	1.9985	1.9898	—	1.9624	1.9573	1.9324	2B	1.940	1.953	1.9639	1.9706	2.0000
2-20 UN	2A	0.0015	1.9985	1.9904	—	1.9660	1.9611	1.9390	2B	1.946	1.957	1.9675	1.9739	2.0000
	3A	0.0000	2.0000	1.9919	—	1.9675	1.9638	1.9405	3B	1.9460	1.9537	1.9675	1.9723	2.0000
2½-16 UNS	2A	0.0016	2.0609	2.0515	—	2.0203	2.0149	1.9864	2B	1.995	2.009	2.0219	2.0289	2.0625
	3A	0.0000	2.0625	2.0531	—	2.0219	2.0179	1.9880	3B	1.9950	2.0033	2.0219	2.0271	2.0625
2⅝-6 UN	2A	0.0026	2.1224	2.1042	—	2.0141	2.0054	1.9240	2B	1.945	1.975	2.0167	2.0280	2.1250
	3A	0.0000	2.1250	2.1068	—	2.0167	2.0102	1.9266	3B	1.9450	1.9646	2.0167	2.0251	2.1250
2⅝-8 UN	2A	0.0024	2.1226	2.1076	2.1001	2.0414	2.0335	1.9738	2B	1.990	2.015	2.0438	2.0540	2.1250
	3A	0.0000	2.1250	2.1100	—	2.0438	2.0379	1.9762	3B	1.9900	2.0047	2.0438	2.0515	2.1250
2⅝-12 UN	2A	0.0018	2.1232	2.1118	—	2.0691	2.0630	2.0240	2B	2.035	2.053	2.0709	2.0788	2.1250
	3A	0.0000	2.1250	2.1136	—	2.0709	2.0664	2.0258	3B	2.0350	2.0448	2.0709	2.0768	2.1250
2⅝-16 UN	2A	0.0016	2.1234	2.1140	—	2.0828	2.0774	2.0489	2B	2.057	2.071	2.0844	2.0914	2.1250
	3A	0.0000	2.1250	2.1156	—	2.0844	2.0803	2.0505	3B	2.0570	2.0658	2.0844	2.0896	2.1250
2⅝-20 UN	2A	0.0015	2.1235	2.1154	—	2.0910	2.0861	2.0640	2B	2.071	2.082	2.0925	2.0989	2.1250
	3A	0.0000	2.1250	2.1169	—	2.0925	2.0888	2.0655	3B	2.0710	2.0787	2.0925	2.0973	2.1250

Table 3. (Continued) Standard Series and Selected Combinations — Unified Screw Threads

Nominal Size, Threads per Inch, and Series Designation ^a	External ^b							Internal ^b						
	Class	Allow- ance	Major Diameter			Pitch Diameter		UNR Minor Dia., ^c Max (Ref.)	Class	Minor Diameter		Pitch Diameter		Major Diameter
			Max ^d	Min	Min ^e	Max ^d	Min			Min	Max	Min	Max	
2 $\frac{3}{16}$ -16 UNS	2A	0.0016	2.1859	2.1765	—	2.1453	2.1399	2.1114	2B	2.120	2.134	2.1469	2.1539	2.1875
	3A	0.0000	2.1875	2.1781	—	2.1469	2.1428	2.1130	3B	2.1200	2.1283	2.1469	2.1521	2.1875
2 $\frac{1}{4}$ -4 $\frac{1}{2}$ UNC	1A	0.0029	2.2471	2.2141	—	2.1028	2.0882	1.9824	1B	2.009	2.045	2.1057	2.1247	2.2500
	2A	0.0029	2.2471	2.2251	2.2141	2.1028	2.0931	1.9824	2B	2.009	2.045	2.1057	2.1183	2.2500
2 $\frac{1}{4}$ -6 UN	3A	0.0000	2.2500	2.2280	—	2.1057	2.0984	1.9853	3B	2.0090	2.0361	2.1057	2.1152	2.2500
	2A	0.0026	2.2474	2.2292	—	2.1391	2.1303	2.0490	2B	2.070	2.100	2.1417	2.1531	2.2500
2 $\frac{1}{4}$ -8 UN	3A	0.0000	2.2500	2.2318	—	2.1417	2.1351	2.0516	3B	2.0700	2.0896	2.1417	2.1502	2.2500
	2A	0.0024	2.2476	2.2326	2.2251	2.1664	2.1584	2.0988	2B	2.115	2.140	2.1688	2.1792	2.2500
2 $\frac{1}{4}$ -10 UNS	3A	0.0000	2.2500	2.2350	—	2.1688	2.1628	2.1012	3B	2.1150	2.1297	2.1688	2.1766	2.2500
	2A	0.0020	2.2480	2.2351	—	2.1830	2.1765	2.1290	2B	2.142	2.163	2.1850	2.1935	2.2500
2 $\frac{1}{4}$ -12 UN	2A	0.0018	2.2482	2.2368	—	2.1941	2.1880	2.1490	2B	2.160	2.178	2.1959	2.2038	2.2500
	3A	0.0000	2.2500	2.2386	—	2.1959	2.1914	2.1508	3B	2.1600	2.1698	2.1959	2.2018	2.2500
2 $\frac{1}{4}$ -14 UNS	2A	0.0017	2.2483	2.2380	—	2.2019	2.1962	2.1633	2B	2.173	2.188	2.2036	2.2110	2.2500
	2A	0.0016	2.2484	2.2390	—	2.2078	2.2024	2.1739	2B	2.182	2.196	2.2094	2.2164	2.2500
2 $\frac{1}{4}$ -16 UN	3A	0.0000	2.2500	2.2406	—	2.2094	2.2053	2.1755	3B	2.1820	2.1908	2.2094	2.2146	2.2500
	2A	0.0015	2.2485	2.2398	—	2.2124	2.2073	2.1824	2B	2.190	2.203	2.2139	2.2206	2.2500
2 $\frac{1}{4}$ -20 UN	2A	0.0015	2.2485	2.2404	—	2.2160	2.2111	2.1890	2B	2.196	2.207	2.2175	2.2239	2.2500
	3A	0.0000	2.2500	2.2419	—	2.2175	2.2137	2.1905	3B	2.1960	2.2037	2.2175	2.2223	2.2500
2 $\frac{5}{16}$ -16 UNS	2A	0.0017	2.3108	2.3014	—	2.2702	2.2647	2.2363	2B	2.245	2.259	2.2719	2.2791	2.3125
	3A	0.0000	2.3125	2.3031	—	2.2719	2.2678	2.2380	3B	2.2450	2.2533	2.2719	2.2773	2.3125
2 $\frac{3}{8}$ -6 UN	2A	0.0027	2.3723	2.3541	—	2.2640	2.2551	2.1739	2B	2.195	2.226	2.2667	2.2782	2.3750
	3A	0.0000	2.3750	2.3568	—	2.2667	2.2601	2.1766	3B	2.1950	2.2146	2.2667	2.2753	2.3750
2 $\frac{3}{8}$ -8 UN	2A	0.0024	2.3726	2.3576	—	2.2914	2.2833	2.2238	2B	2.240	2.265	2.2938	2.3043	2.3750
	3A	0.0000	2.3750	2.3600	—	2.2938	2.2878	2.2262	3B	2.2400	2.2547	2.2938	2.3017	2.3750
2 $\frac{3}{8}$ -12 UN	2A	0.0019	2.3731	2.3617	—	2.3190	2.3128	2.2739	2B	2.285	2.303	2.3209	2.3290	2.3750
	3A	0.0000	2.3750	2.3636	—	2.3209	2.3163	2.2758	3B	2.2850	2.2948	2.3209	2.3269	2.3750
2 $\frac{3}{8}$ -16 UN	2A	0.0017	2.3733	2.3639	—	2.3327	2.3272	2.2988	2B	2.307	2.321	2.3344	2.3416	2.3750
	3A	0.0000	2.3750	2.3656	—	2.3344	2.3303	2.3005	3B	2.3070	2.3158	2.3344	2.3398	2.3750

Table 3. (Continued) Standard Series and Selected Combinations — Unified Screw Threads

Nominal Size, Threads per Inch, and Series Designation ^a	External ^b								Internal ^b					
	Class	Allow- ance	Major Diameter			Pitch Diameter		UNR Minor Dia., ^c Max (Ref.)	Class	Minor Diameter		Pitch Diameter		Major Diameter
			Max ^d	Min	Min ^e	Max ^d	Min			Min	Max	Min	Max	
2 $\frac{3}{8}$ -20 UN	2A	0.0015	2.3735	2.3654	—	2.3410	2.3359	2.3140	2B	2.321	2.332	2.3425	2.3491	2.3750
	3A	0.0000	2.3750	2.3669	—	2.3425	2.3387	2.3155	3B	2.3210	2.3287	2.3425	2.3475	2.3750
2 $\frac{1}{16}$ -16 UNS	2A	0.0017	2.4358	2.4264	—	2.3952	2.3897	2.3613	2B	2.370	2.384	2.3969	2.4041	2.4375
	3A	0.0000	2.4375	2.4281	—	2.3969	2.3928	2.3630	3B	2.3700	2.3783	2.3969	2.4023	2.4375
2 $\frac{1}{2}$ -4 UNC	1A	0.0031	2.4969	2.4612	—	2.3345	2.3190	2.1992	1B	2.229	2.267	2.3376	2.3578	2.5000
	2A	0.0031	2.4969	2.4731	2.4612	2.3345	2.3241	2.1992	2B	2.229	2.267	2.3376	2.3511	2.5000
	3A	0.0000	2.5000	2.4762	—	2.3376	2.3298	2.2023	3B	2.2290	2.2594	2.3376	2.3477	2.5000
2 $\frac{1}{2}$ -6 UN	2A	0.0027	2.4973	2.4791	—	2.3890	2.3800	2.2989	2B	2.320	2.350	2.3917	2.4033	2.5000
	3A	0.0000	2.5000	2.4818	—	2.3917	2.3850	2.3016	3B	2.3200	2.3396	2.3917	2.4004	2.5000
2 $\frac{1}{2}$ -8 UN	2A	0.0024	2.4976	2.4826	2.4751	2.4164	2.4082	2.3488	2B	2.365	2.390	2.4188	2.4294	2.5000
	3A	0.0000	2.5000	2.4850	—	2.4188	2.4127	2.3512	3B	2.3650	2.3797	2.4188	2.4268	2.5000
2 $\frac{1}{2}$ -10 UNS	2A	0.0020	2.4980	2.4851	—	2.4330	2.4263	2.3790	2B	2.392	2.413	2.4350	2.4437	2.5000
2 $\frac{1}{2}$ -12 UN	2A	0.0019	2.4981	2.4867	—	2.4440	2.4378	2.3989	2B	2.410	2.428	2.4459	2.4540	2.5000
	3A	0.0000	2.5000	2.4886	—	2.4459	2.4413	2.4008	3B	2.4100	2.4198	2.4459	2.4519	2.5000
2 $\frac{1}{2}$ -14 UNS	2A	0.0017	2.4983	2.4880	—	2.4519	2.4461	2.4133	2B	2.423	2.438	2.4536	2.4612	2.5000
2 $\frac{1}{2}$ -16 UN	2A	0.0017	2.4983	2.4889	—	2.4577	2.4522	2.4238	2B	2.432	2.446	2.4594	2.4666	2.5000
	3A	0.0000	2.5000	2.4906	—	2.4594	2.4553	2.4255	3B	2.4320	2.4408	2.4594	2.4648	2.5000
2 $\frac{1}{2}$ -18 UNS	2A	0.0016	2.4984	2.4897	—	2.4623	2.4570	2.4323	2B	2.440	2.453	2.4639	2.4708	2.5000
	2A	0.0015	2.4985	2.4904	—	2.4660	2.4609	2.4390	2B	2.446	2.457	2.4675	2.4741	2.5000
2 $\frac{5}{8}$ -6 UN	3A	0.0000	2.5000	2.4919	—	2.4675	2.4637	2.4405	3B	2.4460	2.4537	2.4675	2.4725	2.5000
	2A	0.0027	2.6223	2.6041	—	2.5140	2.5050	2.4239	2B	2.445	2.475	2.5167	2.5285	2.6250
2 $\frac{5}{8}$ -8 UN	3A	0.0000	2.6250	2.6068	—	2.5167	2.5099	2.4266	3B	2.4450	2.4646	2.5167	2.5255	2.6250
	2A	0.0025	2.6225	2.6075	—	2.5413	2.5331	2.4737	2B	2.490	2.515	2.5438	2.5545	2.6250
	3A	0.0000	2.6250	2.6100	—	2.5438	2.5376	2.4762	3B	2.4900	2.5047	2.5438	2.5518	2.6250
2 $\frac{5}{8}$ -12 UN	2A	0.0019	2.6231	2.6117	—	2.5690	2.5628	2.5239	2B	2.535	2.553	2.5709	2.5790	2.6250
	3A	0.0000	2.6250	2.6136	—	2.5709	2.5663	2.5258	3B	2.5350	2.5448	2.5709	2.5769	2.6250
2 $\frac{5}{8}$ -16 UN	2A	0.0017	2.6233	2.6139	—	2.5827	2.5772	2.5488	2B	2.557	2.571	2.5844	2.5916	2.6250
	3A	0.0000	2.6250	2.6156	—	2.5844	2.5803	2.5505	3B	2.5570	2.5658	2.5844	2.5898	2.6250

Table 3. (Continued) Standard Series and Selected Combinations — Unified Screw Threads

Nominal Size, Threads per Inch, and Series Designation ^a	External ^b								Internal ^b					
	Class	Allow- ance	Major Diameter			Pitch Diameter		UNR Minor Dia., ^c Max (Ref.)	Class	Minor Diameter		Pitch Diameter		Major Diameter
			Max ^d	Min	Min ^e	Max ^d	Min			Min	Max	Min	Max	
2 $\frac{3}{8}$ -20 UN	2A	0.0015	2.6235	2.6154	—	2.5910	2.5859	2.5640	2B	2.571	2.582	2.5925	2.5991	2.6250
	3A	0.0000	2.6250	2.6169	—	2.5925	2.5887	2.5655	3B	2.5710	2.5787	2.5925	2.5975	2.6250
2 $\frac{3}{4}$ -4 UNC	1A	0.0032	2.7468	2.7111	—	2.5844	2.5686	2.4491	1B	2.479	2.517	2.5876	2.6082	2.7500
	2A	0.0032	2.7468	2.7230	2.7111	2.5844	2.5739	2.4491	2B	2.479	2.517	2.5876	2.6013	2.7500
2 $\frac{3}{4}$ -6 UN	3A	0.0000	2.7500	2.7262	—	2.5876	2.5797	2.4523	3B	2.4790	2.5094	2.5876	2.5979	2.7500
	2A	0.0027	2.7473	2.7291	—	2.6390	2.6299	2.5489	2B	2.570	2.600	2.6417	2.6536	2.7500
2 $\frac{3}{4}$ -8 UN	3A	0.0000	2.7500	2.7318	—	2.6417	2.6349	2.5516	3B	2.5700	2.5896	2.6417	2.6506	2.7500
	2A	0.0025	2.7475	2.7325	2.7250	2.6663	2.6580	2.5987	2B	2.615	2.640	2.6688	2.6796	2.7500
2 $\frac{3}{4}$ -10 UNS	3A	0.0000	2.7500	2.7350	—	2.6688	2.6625	2.6012	3B	2.6150	2.6297	2.6688	2.6769	2.7500
	2A	0.0020	2.7480	2.7351	—	2.6830	2.6763	2.6290	2B	2.642	2.663	2.6850	2.6937	2.7500
2 $\frac{3}{4}$ -12 UN	2A	0.0019	2.7481	2.7367	—	2.6940	2.6878	2.6489	2B	2.660	2.678	2.6959	2.7040	2.7500
	3A	0.0000	2.7500	2.7386	—	2.6959	2.6913	2.6508	3B	2.6600	2.6698	2.6959	2.7019	2.7500
2 $\frac{3}{4}$ -14 UNS	2A	0.0017	2.7483	2.7380	—	2.7019	2.6961	2.6633	2B	2.673	2.688	2.7036	2.7112	2.7500
	2A	0.0017	2.7483	2.7389	—	2.7077	2.7022	2.6738	2B	2.682	2.696	2.7094	2.7166	2.7500
2 $\frac{3}{4}$ -16 UN	3A	0.0000	2.7500	2.7406	—	2.7094	2.7053	2.6755	3B	2.6820	2.6908	2.7094	2.7148	2.7500
	2A	0.0016	2.7484	2.7397	—	2.7123	2.7070	2.6823	2B	2.690	2.703	2.7139	2.7208	2.7500
2 $\frac{3}{4}$ -20 UN	2A	0.0015	2.7485	2.7404	—	2.7160	2.7109	2.6890	2B	2.696	2.707	2.7175	2.7241	2.7500
	3A	0.0000	2.7500	2.7419	—	2.7175	2.7137	2.6905	3B	2.6960	2.7037	2.7175	2.7225	2.7500
2 $\frac{7}{8}$ -6 UN	2A	0.0028	2.8722	2.8540	—	2.7639	2.7547	2.6738	2B	2.695	2.725	2.7667	2.7787	2.8750
	3A	0.0000	2.8750	2.8568	—	2.7667	2.7598	2.6766	3B	2.6950	2.7146	2.7667	2.7757	2.8750
2 $\frac{7}{8}$ -8 UN	2A	0.0025	2.8725	2.8575	—	2.7913	2.7829	2.7237	2B	2.740	2.765	2.7938	2.8048	2.8750
	3A	0.0000	2.8750	2.8600	—	2.7938	2.7875	2.7262	3B	2.7400	2.7547	2.7938	2.8020	2.8750
2 $\frac{7}{8}$ -12 UN	2A	0.0019	2.8731	2.8617	—	2.8190	2.8127	2.7739	2B	2.785	2.803	2.8209	2.8291	2.8750
	3A	0.0000	2.8750	2.8636	—	2.8209	2.8162	2.7758	3B	2.7850	2.7948	2.8209	2.8271	2.8750
2 $\frac{7}{8}$ -16 UN	2A	0.0017	2.8733	2.8639	—	2.8327	2.8271	2.7988	2B	2.807	2.821	2.8344	2.8417	2.8750
	3A	0.0000	2.8750	2.8656	—	2.8344	2.8302	2.8005	3B	2.8070	2.8158	2.8344	2.8399	2.8750
2 $\frac{7}{8}$ -20 UN	2A	0.0016	2.8734	2.8653	—	2.8409	2.8357	2.8139	2B	2.821	2.832	2.8425	2.8493	2.8750
	3A	0.0000	2.8750	2.8669	—	2.8425	2.8386	2.8155	3B	2.8210	2.8287	2.8425	2.8476	2.8750

Table 3. (Continued) Standard Series and Selected Combinations — Unified Screw Threads

Nominal Size, Threads per Inch, and Series Designation ^a	External ^b							Internal ^b						
	Class	Allow- ance	Major Diameter			Pitch Diameter		UNR Minor Dia., ^c Max (Ref.)	Class	Minor Diameter		Pitch Diameter		Major Diameter
			Max ^d	Min	Min ^e	Max ^d	Min			Min	Max	Min	Max	
3-4 UNC	1A	0.0032	2.9968	2.9611	—	2.8344	2.8183	2.6991	1B	2.729	2.767	2.8376	2.8585	3.0000
	2A	0.0032	2.9968	2.9730	2.9611	2.8344	2.8237	2.6991	2B	2.729	2.767	2.8376	2.8515	3.0000
	3A	0.0000	3.0000	2.9762	—	2.8376	2.8296	2.7023	3B	2.7290	2.7594	2.8376	2.8480	3.0000
3-6 UN	2A	0.0028	2.9972	2.9790	—	2.8889	2.8796	2.7988	2B	2.820	2.850	2.8917	2.9038	3.0000
	3A	0.0000	3.0000	2.9818	—	2.8917	2.8847	2.8016	3B	2.8200	2.8396	2.8917	2.9008	3.0000
3-8 UN	2A	0.0026	2.9974	2.9824	2.9749	2.9162	2.9077	2.8486	2B	2.865	2.890	2.9188	2.9299	3.0000
	3A	0.0000	3.0000	2.9850	—	2.9188	2.9124	2.8512	3B	2.8650	2.8797	2.9188	2.9271	3.0000
3-10 UNS	2A	0.0020	2.9980	2.9851	—	2.9330	2.9262	2.8790	2B	2.892	2.913	2.9350	2.9439	3.0000
3-12 UN	2A	0.0019	2.9981	2.9867	—	2.9440	2.9377	2.8989	2B	2.910	2.928	2.9459	2.9541	3.0000
	3A	0.0000	3.0000	2.9886	—	2.9459	2.9412	2.9008	3B	2.9100	2.9198	2.9459	2.9521	3.0000
3-14 UNS	2A	0.0018	2.9982	2.9879	—	2.9518	2.9459	2.9132	2B	2.923	2.938	2.9536	2.9613	3.0000
3-16 UN	2A	0.0017	2.9983	2.9889	—	2.9577	2.9521	2.9238	2B	2.932	2.946	2.9594	2.9667	3.0000
	3A	0.0000	3.0000	2.9906	—	2.9594	2.9552	2.9255	3B	2.9320	2.9408	2.9594	2.9649	3.0000
3-18 UNS	2A	0.0016	2.9984	2.9897	—	2.9623	2.9569	2.9323	2B	2.940	2.953	2.9639	2.9709	3.0000
3-20 UN	2A	0.0016	2.9984	2.9903	—	2.9659	2.9607	2.9389	2B	2.946	2.957	2.9675	2.9743	3.0000
	3A	0.0000	3.0000	2.9919	—	2.9675	2.9636	2.9405	3B	2.9460	2.9537	2.9675	2.9726	3.0000
3 $\frac{1}{8}$ -6 UN	2A	0.0028	3.1222	3.1040	—	3.0139	3.0045	2.9238	2B	2.945	2.975	3.0167	3.0289	3.1250
	3A	0.0000	3.1250	3.1068	—	3.0167	3.0097	2.9266	3B	2.9450	2.9646	3.0167	3.0259	3.1250
3 $\frac{1}{8}$ -8 UN	2A	0.0026	3.1224	3.1074	—	3.0412	3.0326	2.9736	2B	2.990	3.015	3.0438	3.0550	3.1250
	3A	0.0000	3.1250	3.1100	—	3.0438	3.0374	2.9762	3B	2.9900	3.0047	3.0438	3.0522	3.1250
3 $\frac{1}{8}$ -12 UN	2A	0.0019	3.1231	3.1117	—	3.0690	3.0627	3.0239	2B	3.035	3.053	3.0709	3.0791	3.1250
	3A	0.0000	3.1250	3.1136	—	3.0709	3.0662	3.0258	3B	3.0350	3.0448	3.0709	3.0771	3.1250
3 $\frac{1}{8}$ -16 UN	2A	0.0017	3.1233	3.1139	—	3.0827	3.0771	3.0488	2B	3.057	3.071	3.0844	3.0917	3.1250
	3A	0.0000	3.1250	3.1156	—	3.0844	3.0802	3.0505	3B	3.0570	3.0658	3.0844	3.0899	3.1250
3 $\frac{1}{4}$ -4 UNC	1A	0.0033	3.2467	3.2110	—	3.0843	3.0680	2.9490	1B	2.979	3.017	3.0876	3.1088	3.2500
	2A	0.0033	3.2467	3.2229	3.2110	3.0843	3.0734	2.9490	2B	2.979	3.017	3.0876	3.1017	3.2500
	3A	0.0000	3.2500	3.2262	—	3.0876	3.0794	2.9523	3B	2.9790	3.0094	3.0876	3.0982	3.2500
3 $\frac{1}{4}$ -6 UN	2A	0.0028	3.2472	3.2290	—	3.1389	3.1294	3.0488	2B	3.070	3.100	3.1417	3.1540	3.2500
	3A	0.0000	3.2500	3.2318	—	3.1417	3.1346	3.0516	3B	3.0700	3.0896	3.1417	3.1509	3.2500

Table 3. (Continued) Standard Series and Selected Combinations — Unified Screw Threads

Nominal Size, Threads per Inch, and Series Designation ^a	External ^b								Internal ^b					
	Class	Allow- ance	Major Diameter			Pitch Diameter		UNR Minor Dia., ^c Max (Ref.)	Class	Minor Diameter		Pitch Diameter		Major Diameter
			Max ^d	Min	Min ^e	Max ^d	Min			Min	Max	Min	Max	Min
3/8-8 UN	2A	0.0026	3.2474	3.2324	3.2249	3.1662	3.1575	3.0986	2B	3.115	3.140	3.1688	3.1801	3.2500
	3A	0.0000	3.2500	3.2350	—	3.1688	3.1623	3.1012	3B	3.1150	3.1297	3.1688	3.1773	3.2500
3/8-10 UNS	2A	0.0020	3.2480	3.2351	—	3.1830	3.1762	3.1290	2B	3.142	3.163	3.1850	3.1939	3.2500
3/8-12 UN	2A	0.0019	3.2481	3.2367	—	3.1940	3.1877	3.1489	2B	3.160	3.178	3.1959	3.2041	3.2500
	3A	0.0000	3.2500	3.2386	—	3.1959	3.1912	3.1508	3B	3.1600	3.1698	3.1959	3.2041	3.2500
3/8-14 UNS	2A	0.0018	3.2482	3.2379	—	3.2018	3.1959	3.1632	2B	3.173	3.188	3.2036	3.2113	3.2500
3/8-16 UN	2A	0.0017	3.2483	3.2389	—	3.2077	3.2021	3.1738	2B	3.182	3.196	3.2094	3.2167	3.2500
	3A	0.0000	3.2500	3.2406	—	3.2094	3.2052	3.1755	3B	3.1820	3.1908	3.2094	3.2149	3.2500
3/8-18 UNS	2A	0.0016	3.2484	3.2397	—	3.2123	3.2069	3.1823	2B	3.190	3.203	3.2139	3.2209	3.2500
3/8-6 UN	2A	0.0029	3.3721	3.3539	—	3.2638	3.2543	3.1737	2B	3.195	3.225	3.2667	3.2791	3.3750
	3A	0.0000	3.3750	3.3568	—	3.2667	3.2595	3.1766	3B	3.1950	3.2146	3.2667	3.2760	3.3750
3/8-8 UN	2A	0.0026	3.3724	3.3574	—	3.2912	3.2824	3.2236	2B	3.240	3.265	3.2938	3.3052	3.3750
	3A	0.0000	3.3750	3.3600	—	3.2938	3.2872	3.2262	3B	3.2400	3.2547	3.2938	3.3023	3.3750
3/8-12 UN	2A	0.0019	3.3731	3.3617	—	3.3190	3.3126	3.2739	2B	3.285	3.303	3.3209	3.3293	3.3750
	3A	0.0000	3.3750	3.3636	—	3.3209	3.3161	3.2758	3B	3.2850	3.2948	3.3209	3.3272	3.3750
3/8-16 UN	2A	0.0017	3.3733	3.3639	—	3.3327	3.3269	3.2988	2B	3.307	3.321	3.3344	3.3419	3.3750
	3A	0.0000	3.3750	3.3656	—	3.3344	3.3301	3.3005	3B	3.3070	3.3158	3.3344	3.3400	3.3750
3/2-4 UNC	1A	0.0033	3.4967	3.4610	—	3.3343	3.3177	3.1990	1B	3.329	3.267	3.3376	3.3591	3.5000
	2A	0.0033	3.4967	3.4729	3.4610	3.3343	3.3233	3.1990	2B	3.229	3.267	3.3376	3.3519	3.5000
	3A	0.0000	3.5000	3.4762	—	3.3376	3.3293	3.2023	3B	3.2290	3.2594	3.3376	3.3484	3.5000
3/2-6 UN	2A	0.0029	3.4971	3.4789	—	3.3888	3.3792	3.2987	2B	3.320	3.350	3.3917	3.4042	3.5000
	3A	0.0000	3.5000	3.4818	—	3.3917	3.3845	3.3016	3B	3.3200	3.3396	3.3917	3.4011	3.5000
3/2-8 UN	2A	0.0026	3.4974	3.4824	3.4749	3.4162	3.4074	3.3486	2B	3.365	3.390	3.4188	3.4303	3.5000
	3A	0.0000	3.5000	3.4850	—	3.4188	3.4122	3.3512	3B	3.3650	3.3797	3.4188	3.4274	3.5000
3/2-10 UNS	2A	0.0021	3.4979	3.4850	—	3.4329	3.4260	3.3789	2B	3.392	3.413	3.4350	3.4440	3.5000
3/2-12 UN	2A	0.0019	3.4981	3.4867	—	3.4440	3.4376	3.3989	2B	3.410	3.428	3.4459	3.4543	3.5000
	3A	0.0000	3.5000	3.4886	—	3.4459	3.4411	3.4008	3B	3.4100	3.4198	3.4459	3.4522	3.5000

Table 3. (Continued) Standard Series and Selected Combinations — Unified Screw Threads

Nominal Size, Threads per Inch, and Series Designation ^a	External ^b								Internal ^b					
	Class	Allow- ance	Major Diameter			Pitch Diameter		UNR Minor Dia., ^c Max (Ref.)	Class	Minor Diameter		Pitch Diameter		Major Diameter
			Max ^d	Min	Min ^e	Max ^d	Min			Min	Max	Min	Max	
3½-14 UNS	2A	0.0018	3.4982	3.4879	—	3.4518	3.4457	3.4132	2B	3.423	3.438	3.4536	3.4615	3.5000
3½-16 UN	2A	0.0017	3.4983	3.4889	—	3.4577	3.4519	3.4238	2B	3.432	3.446	3.4594	3.4669	3.5000
	3A	0.0000	3.5000	3.4906	—	3.4594	3.4551	3.4255	3B	3.4320	3.4408	3.4594	3.4650	3.5000
3½-18 UNS	2A	0.0017	3.4983	3.4896	—	3.4622	3.4567	3.4322	2B	3.440	3.453	3.4639	3.4711	3.5000
	3A	0.0029	3.6221	3.6039	—	3.5138	3.5041	3.4237	2B	3.445	3.475	3.5167	3.5293	3.6250
3⅝-6 UN	2A	0.0029	3.6221	3.6039	—	3.5138	3.5041	3.4237	2B	3.445	3.475	3.5167	3.5293	3.6250
	3A	0.0000	3.6250	3.6068	—	3.5167	3.5094	3.4266	3B	3.4450	3.4646	3.5167	3.5262	3.6250
3⅝-8 UN	2A	0.0027	3.6223	3.6073	—	3.5411	3.5322	3.4735	2B	3.490	3.515	3.5438	3.5554	3.6250
	3A	0.0000	3.6250	3.6100	—	3.5438	3.5371	3.4762	3B	3.4900	3.5047	3.5438	3.5525	3.6250
3⅝-12 UN	2A	0.0019	3.6231	3.6117	—	3.5690	3.5626	3.5239	2B	3.535	3.553	3.5709	3.5793	3.6250
	3A	0.0000	3.6250	3.6136	—	3.5709	3.5661	3.5258	3B	3.5350	3.5448	3.5709	3.5772	3.6250
3⅝-16 UN	2A	0.0017	3.6233	3.6139	—	3.5827	3.5769	3.5488	2B	3.557	3.571	3.5844	3.5919	3.6250
	3A	0.0000	3.6250	3.6156	—	3.5844	3.5801	3.5505	3B	3.5570	3.5658	3.5844	3.5900	3.6250
3¾-4 UNC	1A	0.0034	3.7466	3.7109	—	3.5842	3.5674	3.4489	1B	3.479	3.517	3.5876	3.6094	3.7500
	2A	0.0034	3.7466	3.7228	3.7109	3.5842	3.5730	3.4489	2B	3.479	3.517	3.5876	3.6021	3.7500
3¾-6 UN	3A	0.0000	3.7500	3.7262	—	3.5876	3.5792	3.4523	3B	3.4790	3.5094	3.5876	3.5985	3.7500
	2A	0.0029	3.7471	3.7289	—	3.6388	3.6290	3.5487	2B	3.570	3.600	3.6417	3.6544	3.7500
3¾-8 UN	3A	0.0000	3.7500	3.7318	—	3.6417	3.6344	3.5516	3B	3.5700	3.5896	3.6417	3.6512	3.7500
	2A	0.0027	3.7473	3.7323	3.7248	3.6661	3.6571	3.5985	2B	3.615	3.640	3.6688	3.6805	3.7500
3¾-10 UNS	3A	0.0000	3.7500	3.7350	—	3.6688	3.6621	3.6012	3B	3.6150	3.6297	3.6688	3.6776	3.7500
	2A	0.0021	3.7479	3.7350	—	3.6829	3.6760	3.6289	2B	3.642	3.663	3.6850	3.6940	3.7500
3¾-12 UN	2A	0.0019	3.7481	3.7367	—	3.6940	3.6876	3.6489	2B	3.660	3.678	3.6959	3.7043	3.7500
	3A	0.0000	3.7500	3.7386	—	3.6959	3.6911	3.6508	3B	3.6600	3.6698	3.6959	3.7022	3.7500
3¾-14 UNS	2A	0.0018	3.7482	3.7379	—	3.7018	3.6957	3.6632	2B	3.673	3.688	3.7036	3.7115	3.7500
	3A	0.0017	3.7483	3.7389	—	3.7077	3.7019	3.6738	2B	3.682	3.696	3.7094	3.7169	3.7500
3¾-16 UN	2A	0.0017	3.7483	3.7389	—	3.7077	3.7019	3.6738	2B	3.682	3.696	3.7094	3.7169	3.7500
	3A	0.0000	3.7500	3.7406	—	3.7094	3.7051	3.6755	3B	3.6820	3.6908	3.7094	3.7150	3.7500
3¾-18 UNS	2A	0.0017	3.7483	3.7396	—	3.7122	3.7067	3.6822	2B	3.690	3.703	3.7139	3.7211	3.7500

Table 3. (Continued) Standard Series and Selected Combinations — Unified Screw Threads

Nominal Size, Threads per Inch, and Series Designation ^a	External ^b							Internal ^b						
	Class	Allow- ance	Major Diameter			Pitch Diameter		UNR Minor Dia., ^c Max (Ref.)	Class	Minor Diameter		Pitch Diameter		Major Diameter
			Max ^d	Min	Min ^e	Max ^d	Min			Min	Max	Min	Max	
3/8-6 UN	2A	0.0030	3.8720	3.8538	—	3.7637	3.7538	3.6736	2B	3.695	3.725	3.7667	3.7795	3.8750
	3A	0.0000	3.8750	3.8568	—	3.7667	3.7593	3.6766	3B	3.6950	3.7146	3.7667	3.7763	3.8750
3/8-8 UN	2A	0.0027	3.8723	3.8573	—	3.7911	3.7820	3.7235	2B	3.740	3.765	3.7938	3.8056	3.8750
	3A	0.0000	3.8750	3.8600	—	3.7938	3.7870	3.7262	3B	3.7400	3.7547	3.7938	3.8026	3.8750
3/8-12 UN	2A	0.0020	3.8730	3.8616	—	3.8189	3.8124	3.7738	2B	3.785	3.803	3.8209	3.8294	3.8750
	3A	0.0000	3.8750	3.8636	—	3.8209	3.8160	3.7758	3B	3.7850	3.7948	3.8209	3.8273	3.8750
3/8-16 UN	2A	0.0018	3.8732	3.8638	—	3.8326	3.8267	3.7987	2B	3.807	3.821	3.8344	3.8420	3.8750
	3A	0.0000	3.8750	3.8656	—	3.8344	3.8300	3.8005	3B	3.8070	3.8158	3.8344	3.8401	3.8750
4-4 UNC	1A	0.0034	3.9966	3.9609	—	3.8342	3.8172	3.6989	1B	3.729	3.767	3.8376	3.8597	4.0000
	2A	0.0034	3.9966	3.9728	3.9609	3.8342	3.8229	3.6989	2B	3.729	3.767	3.8376	3.8523	4.0000
	3A	0.0000	4.0000	3.9762	—	3.8376	3.8291	3.7023	3B	3.7290	3.7594	3.8376	3.8487	4.0000
4-6 UN	2A	0.0030	3.9970	3.9788	—	3.8887	3.8788	3.7986	2B	3.820	3.850	3.8917	3.9046	4.0000
	3A	0.0000	4.0000	3.9818	—	3.8917	3.8843	3.8016	3B	3.8200	3.8396	3.8917	3.9014	4.0000
4-8 UN	2A	0.0027	3.9973	3.9823	3.9748	3.9161	3.9070	3.8485	2B	3.865	3.890	3.9188	3.9307	4.0000
	3A	0.0000	4.0000	3.9850	—	3.9188	3.9120	3.8512	3B	3.8650	3.8797	3.9188	3.9277	4.0000
4-10 UNS	2A	0.0021	3.9979	3.9850	—	3.9329	3.9259	3.8768	2B	3.892	3.913	3.9350	3.9441	4.0000
4-12 UN	2A	0.0020	3.9980	3.9866	—	3.9439	3.9374	3.8988	2B	3.910	3.928	3.9459	3.9544	4.0000
	3A	0.0000	4.0000	3.9886	—	3.9459	3.9410	3.9008	3B	3.9100	3.9198	3.9459	3.9523	4.0000
4-14 UNS	2A	0.0018	3.9982	3.9879	—	3.9518	3.9456	3.9132	2B	3.923	3.938	3.9536	3.9616	4.0000
4-16 UN	2A	0.0018	3.9982	3.9888	—	3.9576	3.9517	3.9237	2B	3.932	3.946	3.9594	3.9670	4.0000
	3A	0.0000	4.0000	3.9906	—	3.9594	3.9550	3.9255	3B	3.9320	3.9408	3.9594	3.9651	4.0000
4 1/2-10 UNS	2A	0.0021	4.2479	4.2350	—	4.1829	4.1759	4.1289	2B	4.142	4.163	4.1850	4.1941	4.2500
4 1/2-14 UNS	2A	0.0018	4.2482	4.2379	—	4.2018	4.1956	4.1632	2B	4.173	4.188	4.2036	4.2116	4.2500
4 1/2-12 UN	2A	0.0020	4.2480	4.2366	—	4.1939	4.1874	4.1488	2B	4.160	4.178	4.1959	4.2044	4.2500
	3A	0.0000	4.2500	4.2386	—	4.1959	4.1910	4.1508	3B	4.1600	4.1698	4.1959	4.2023	4.2500
4 1/2-16 UN	2A	0.0018	4.2482	4.2388	—	4.2076	4.2017	4.1737	2B	4.182	4.196	4.2094	4.2170	4.2500
	3A	0.0000	4.2500	4.2406	—	4.2094	4.2050	4.1755	3B	4.1820	4.1900	4.2094	4.2151	4.2500
4 1/2-10 UNS	2A	0.0021	4.4979	4.4850	—	4.4329	4.4259	4.3789	2B	4.392	4.413	4.4350	4.4441	4.5000
4 1/2-14 UNS	2A	0.0018	4.4982	4.4879	—	4.4518	4.4456	4.4132	2B	4.423	4.438	4.4536	4.4616	4.5000

Table 3. (Continued) Standard Series and Selected Combinations — Unified Screw Threads

Nominal Size, Threads per Inch, and Series Designation ^a	External ^b								Internal ^b					
	Class	Allow- ance	Major Diameter			Pitch Diameter		UNR Minor Dia., ^c Max (Ref.)	Class	Minor Diameter		Pitch Diameter		Major Diameter
			Max ^d	Min	Min ^e	Max ^d	Min			Min	Max	Min	Max	Min
4½-12 UN	2A	0.0020	4.4980	4.4866	—	4.4439	4.4374	4.3988	2B	4.410	4.428	4.4459	4.4544	4.5000
	3A	0.0000	4.5000	4.4886	—	4.4459	4.4410	4.4008	3B	4.4100	4.4198	4.4459	4.4523	4.5000
4½-16 UN	2A	0.0018	4.4982	4.4888	—	4.4576	4.4517	4.4237	2B	4.432	4.446	4.4594	4.4670	4.5000
	3A	0.0000	4.5000	4.4906	—	4.4594	4.4550	4.4255	3B	4.4320	4.4408	4.4594	4.4651	4.5000
4¾-10 UNS	2A	0.0022	4.7478	4.7349	—	4.6828	4.6756	4.6288	2B	4.642	4.663	4.6850	4.6944	4.7500
4¾-14 UNS	2A	0.0019	4.7481	4.7378	—	4.7017	4.6953	4.6631	2B	4.673	4.688	4.7036	4.7119	4.7500
4¾-12 UN	2A	0.0020	4.7480	4.7366	—	4.6939	4.6872	4.6488	2B	4.660	4.678	4.6959	4.7046	4.7500
	3A	0.0000	4.7500	4.7386	—	4.6959	4.6909	4.6508	3B	4.6600	4.6698	4.6959	4.7025	4.7500
4¾-16 UN	2A	0.0018	4.7482	4.7388	—	4.7076	4.7015	4.6737	2B	4.682	4.696	4.7094	4.7173	4.7500
	3A	0.0000	4.7500	4.7406	—	4.7094	4.7049	4.6755	3B	4.6820	4.6908	4.7094	4.7153	4.7500
5.00-10 UNS	2A	0.0022	4.9978	4.9849	—	4.9328	4.9256	4.8788	2B	4.892	4.913	4.9350	4.9444	5.0000
5.00-14 UNS	2A	0.0019	4.9981	4.9878	—	4.9517	4.9453	4.9131	2B	4.923	4.938	4.9536	4.9619	5.0000
5.00-12 UN	2A	0.0020	4.9980	4.9866	—	4.9439	4.9372	4.8988	2B	4.910	4.928	4.9459	4.9546	5.0000
	3A	0.0000	5.0000	4.9886	—	4.9459	4.9409	4.9008	3B	4.9100	4.9198	4.9459	4.9525	5.0000
5.00-16 UN	2A	0.0018	4.9982	4.9888	—	4.9576	4.9515	4.9237	2B	4.932	4.946	4.9594	4.9673	5.0000
	3A	0.0000	5.0000	4.9906	—	4.9594	4.9549	4.9255	3B	4.9320	4.9408	4.9594	4.9653	5.0000
5½-10 UNS	2A	0.0022	5.2478	5.2349	—	5.1829	5.1756	5.1288	2B	5.142	5.163	5.1850	5.1944	5.2500
5½-14 UNS	2A	0.0019	5.2481	5.2378	—	5.2017	5.1953	5.1631	2B	5.173	5.188	5.2036	5.2119	5.2500
5½-12 UN	2A	0.0020	5.2480	5.2366	—	5.1939	5.1872	5.1488	2B	5.160	5.178	5.1959	5.2046	5.2500
	3A	0.0000	5.2500	5.2386	—	5.1959	5.1909	5.1508	3B	5.1600	5.1698	5.1959	5.2025	5.2500
5½-16 UN	2A	0.0018	5.2482	5.2388	—	5.2076	5.2015	5.1737	2B	5.182	5.196	5.2094	5.2173	5.2500
	3A	0.0000	5.2500	5.2406	—	5.2094	5.2049	5.1755	3B	5.1820	5.1908	5.2094	5.2153	5.2500
5½-10 UNS	2A	0.0022	5.4978	5.4849	—	5.4328	5.4256	5.3788	2B	5.392	5.413	5.4350	5.4444	5.5000
5½-14 UNS	2A	0.0019	5.4981	5.4878	—	5.4517	5.4453	5.4131	2B	5.423	5.438	5.4536	5.4619	5.5000
5½-12 UN	2A	0.0020	5.4980	5.4866	—	5.4439	5.4372	5.3988	2B	5.410	5.428	5.4459	5.4546	5.5000
	3A	0.0000	5.5000	5.4886	—	5.4459	5.4409	5.4008	3B	5.4100	5.4198	5.4459	5.4525	5.5000
5½-16 UN	2A	0.0018	5.4982	5.4888	—	5.4576	5.4515	5.4237	2B	5.432	5.446	5.4594	5.4673	5.5000
	3A	0.0000	5.5000	5.4906	—	5.4594	5.4549	5.4255	3B	5.4320	5.4408	5.4594	5.4653	5.5000

Table 3. (Continued) Standard Series and Selected Combinations — Unified Screw Threads

Nominal Size, Threads per Inch, and Series Designation ^a	External ^b								Internal ^b					
	Class	Allow- ance	Major Diameter			Pitch Diameter		UNR Minor Dia., ^c Max (Ref.)	Class	Minor Diameter		Pitch Diameter		Major Diameter
			Max ^d	Min	Min ^e	Max ^d	Min			Min	Max	Min	Max	Min
5/8-10 UNS	2A	0.0022	5.7478	5.7349	—	5.6828	5.6754	5.6288	2B	5.642	5.663	5.6850	5.6946	5.7500
5/8-14 UNS	2A	0.0020	5.7480	5.7377	—	5.7016	5.6951	5.6630	2B	5.673	5.688	5.7036	5.7121	5.7500
5/8-12 UN	2A	0.0021	5.7479	5.7365	—	5.6938	5.6869	5.6487	2B	5.660	5.678	5.6959	5.7049	5.7500
	3A	0.0000	5.7500	5.7386	—	5.6959	5.6907	5.6508	3B	5.6600	5.6698	5.6959	5.7026	5.7500
5/8-16 UN	2A	0.0019	5.7481	5.7387	—	5.7075	5.7013	5.6736	2B	5.682	5.696	5.7094	5.7175	5.7500
	3A	0.0000	5.7500	5.7406	—	5.7094	5.7047	5.6755	3B	5.6820	5.6908	5.7094	5.7155	5.7500
6-10 UNS	2A	0.0022	5.9978	5.9849	—	5.9328	5.9254	5.8788	2B	5.892	5.913	5.9350	5.9446	6.0000
6-14 UNS	2A	0.0020	5.9980	5.9877	—	5.9516	5.9451	5.9130	2B	5.923	5.938	5.9536	5.9621	6.0000
6-12 UN	2A	0.0021	5.9979	5.9865	—	5.9438	5.9369	5.8987	2B	5.910	5.928	5.9459	5.9549	6.0000
	3A	0.0000	6.0000	5.9886	—	5.9459	5.9407	5.9008	3B	5.9100	5.9198	5.9459	5.9526	6.0000
6-16 UN	2A	0.0019	5.9981	5.9887	—	5.9575	5.9513	5.9236	2B	5.932	5.946	5.9594	5.9675	6.0000
	3A	0.0000	6.0000	5.9906	—	5.9594	5.9547	5.9255	3B	5.9320	5.9408	5.9594	5.9655	6.0000

^a Use UNR designation instead of UN wherever UNR thread form is desired for external use.

^b Regarding combinations of thread classes, see text on page 1760.

^c UN series external thread maximum minor diameter is basic for Class 3A and basic minus allowance for Classes 1A and 2A.

^d For Class 2A threads having an additive finish the maximum is increased, by the allowance, to the basic size, the value being the same as for Class 3A.

^e For unfinished hot-rolled material not including standard fasteners with rolled threads.

^f Formerly NF, tolerances and allowances are based on one diameter length of engagement.

All dimensions in inches.

Use UNS threads only if Standard Series do not meet requirements (see pages 1720, 1752, and 1763). For additional sizes above 4 inches see ASME/ANSI B1.1-1989 (R2001).

Coarse-Thread Series: This series, UNC/UNRC, is the one most commonly used in the bulk production of bolts, screws, nuts and other general engineering applications. It is also used for threading into lower tensile strength materials such as cast iron, mild steel and softer materials (bronze, brass, aluminum, magnesium and plastics) to obtain the optimum resistance to stripping of the internal thread. It is applicable for rapid assembly or disassembly, or if corrosion or slight damage is possible.

Table 4a. Coarse-Thread Series, UNC and UNRC — Basic Dimensions

Sizes No. or Inches	Basic Major Dia., <i>D</i>	Thds. per Inch, <i>n</i>	Basic Pitch Dia., ^a <i>D</i> ₂	Minor Diameter		Lead Angle λ at Basic P.D.	Area of Minor Dia. at <i>D</i> -2 <i>h</i> _b	Tensile Stress Area ^b Sq. In.
				Ext. Thds., ^c <i>d</i> ₃ (Ref.)	Int. Thds., ^d <i>D</i> ₁			
				Inches	Inches			
1 (0.073) ^c	0.0730	64	0.0629	0.0544	0.0561	4 31	0.00218	0.00263
2 (0.086)	0.0860	56	0.0744	0.0648	0.0667	4 22	0.00310	0.00370
3 (0.099) ^c	0.0990	48	0.0855	0.0741	0.0764	4 26	0.00406	0.00487
4 (0.112)	0.1120	40	0.0958	0.0822	0.0849	4 45	0.00496	0.00604
5 (0.125)	0.1250	40	0.1088	0.0952	0.0979	4 11	0.00672	0.00796
6 (0.138)	0.1380	32	0.1177	0.1008	0.1042	4 50	0.00745	0.00909
8 (0.164)	0.1640	32	0.1437	0.1268	0.1302	3 58	0.01196	0.0140
10 (0.190)	0.1900	24	0.1629	0.1404	0.1449	4 39	0.01450	0.0175
12 (0.216) ^c	0.2160	24	0.1889	0.1664	0.1709	4 1	0.0206	0.0242
$\frac{1}{4}$	0.2500	20	0.2175	0.1905	0.1959	4 11	0.0269	0.0318
$\frac{5}{16}$	0.3125	18	0.2764	0.2464	0.2524	3 40	0.0454	0.0524
$\frac{3}{8}$	0.3750	16	0.3344	0.3005	0.3073	3 24	0.0678	0.0775
$\frac{7}{16}$	0.4375	14	0.3911	0.3525	0.3602	3 20	0.0933	0.1063
$\frac{1}{2}$	0.5000	13	0.4500	0.4084	0.4167	3 7	0.1257	0.1419
$\frac{9}{16}$	0.5625	12	0.5084	0.4633	0.4723	2 59	0.162	0.182
$\frac{5}{8}$	0.6250	11	0.5660	0.5168	0.5266	2 56	0.202	0.226
$\frac{3}{4}$	0.7500	10	0.6850	0.6309	0.6417	2 40	0.302	0.334
$\frac{7}{8}$	0.8750	9	0.8028	0.7427	0.7547	2 31	0.419	0.462
1	1.0000	8	0.9188	0.8512	0.8647	2 29	0.551	0.606
1 $\frac{1}{8}$	1.1250	7	1.0322	0.9549	0.9704	2 31	0.693	0.763
1 $\frac{1}{4}$	1.2500	7	1.1572	1.0799	1.0954	2 15	0.890	0.969
1 $\frac{3}{8}$	1.3750	6	1.2667	1.1766	1.1946	2 24	1.054	1.155
1 $\frac{1}{2}$	1.5000	6	1.3917	1.3016	1.3196	2 11	1.294	1.405
1 $\frac{3}{4}$	1.7500	5	1.6201	1.5119	1.5335	2 15	1.74	1.90
2	2.0000	4 $\frac{1}{2}$	1.8557	1.7353	1.7594	2 11	2.30	2.50
2 $\frac{1}{4}$	2.2500	4 $\frac{1}{2}$	2.1057	1.9853	2.0094	1 55	3.02	3.25
2 $\frac{1}{2}$	2.5000	4	2.3376	2.2023	2.2294	1 57	3.72	4.00
2 $\frac{3}{4}$	2.7500	4	2.5876	2.4523	2.4794	1 46	4.62	4.93
3	3.0000	4	2.8376	2.7023	2.7294	1 36	5.62	5.97
3 $\frac{1}{4}$	3.2500	4	3.0876	2.9523	2.9794	1 29	6.72	7.10
3 $\frac{1}{2}$	3.5000	4	3.3376	3.2023	3.2294	1 22	7.92	8.33
3 $\frac{3}{4}$	3.7500	4	3.5876	3.4523	3.4794	1 16	9.21	9.66
4	4.0000	4	3.8376	3.7023	3.7294	1 11	10.61	11.08

^a British: Effective Diameter.

^b See formula, pages 1435 and 1443.

^c Design form for UNR threads. (See figure on page 1720.)

^d Basic minor diameter.

^e Secondary sizes.

Fine-Thread Series: This series, UNF/UNRF, is suitable for the production of bolts, screws, and nuts and for other applications where the Coarse series is not applicable. External threads of this series have greater tensile stress area than comparable sizes of the Coarse series. The Fine series is suitable when the resistance to stripping of both external

and mating internal threads equals or exceeds the tensile load carrying capacity of the externally threaded member (see page 1443). It is also used where the length of engagement is short, where a smaller lead angle is desired, where the wall thickness demands a fine pitch, or where finer adjustment is needed.

Table 4b. Fine-Thread Series, UNF and UNRF — Basic Dimensions

Sizes No. or Inches	Basic Major Dia., <i>D</i>	Thds. per Inch, <i>n</i>	Basic Pitch Dia., ^a <i>D</i> ₂	Minor Diameter		Lead Angle λ at Basic P.D.		Area of Minor Dia. at <i>D</i> -2 <i>t</i> _b	Tensile Stress Area ^b
				Ext. Thds., ^c <i>d</i> ₃ (Ref.)	Int. Thds., ^d <i>D</i> ₁	Deg.	Min		
	Inches	Inches	Inches	Sq. In.	Sq. In.				
0 (0.060)	0.0600	80	0.0519	0.0451	0.0465	4	23	0.00151	0.00180
1 (0.073) ^c	0.0730	72	0.0640	0.0565	0.0580	3	57	0.00237	0.00278
2 (0.086)	0.0860	64	0.0759	0.0674	0.0691	3	45	0.00339	0.00394
3 (0.099) ^c	0.0990	56	0.0874	0.0778	0.0797	3	43	0.00451	0.00523
4 (0.112)	0.1120	48	0.0985	0.0871	0.0894	3	51	0.00566	0.00661
5 (0.125)	0.1250	44	0.1102	0.0979	0.1004	3	45	0.00716	0.00830
6 (0.138)	0.1380	40	0.1218	0.1082	0.1109	3	44	0.00874	0.01015
8 (0.164)	0.1640	36	0.1460	0.1309	0.1339	3	28	0.01285	0.01474
10 (0.190)	0.1900	32	0.1697	0.1528	0.1562	3	21	0.0175	0.0200
12 (0.216) ^c	0.2160	28	0.1928	0.1734	0.1773	3	22	0.0226	0.0258
1/4	0.2500	28	0.2268	0.2074	0.2113	2	52	0.0326	0.0364
5/16	0.3125	24	0.2854	0.2629	0.2674	2	40	0.0524	0.0580
3/8	0.3750	24	0.3479	0.3254	0.3299	2	11	0.0809	0.0878
7/16	0.4375	20	0.4050	0.3780	0.3834	2	15	0.1090	0.1187
1/2	0.5000	20	0.4675	0.4405	0.4459	1	57	0.1486	0.1599
9/16	0.5625	18	0.5264	0.4964	0.5024	1	55	0.189	0.203
5/8	0.6250	18	0.5889	0.5589	0.5649	1	43	0.240	0.256
3/4	0.7500	16	0.7094	0.6763	0.6823	1	36	0.351	0.373
7/8	0.8750	14	0.8286	0.7900	0.7977	1	34	0.480	0.509
1	1.0000	12	0.9459	0.9001	0.9098	1	36	0.625	0.663
1 1/8	1.1250	12	1.0709	1.0258	1.0348	1	25	0.812	0.856
1 1/4	1.2500	12	1.1959	1.1508	1.1598	1	16	1.024	1.073
1 3/8	1.3750	12	1.3209	1.2758	1.2848	1	9	1.260	1.315
1 1/2	1.5000	12	1.4459	1.4008	1.4098	1	3	1.521	1.581

^a British: Effective Diameter.

^b See formula, pages 1435 and 1443.

^c Design form for UNR threads. (See figure on page 1720.)

^d Basic minor diameter.

^e Secondary sizes.

Extra-Fine-Thread Series: This series, UNEF/UNREF, is applicable where even finer pitches of threads are desirable, as for short lengths of engagement and for thin-walled tubes, nuts, ferrules, or couplings. It is also generally applicable under the conditions stated above for the fine threads. See Table 4c.

Fine Threads for Thin-Wall Tubing: Dimensions for a 27-thread series, ranging from 1/4- to 1-inch nominal size, also are included in Table 3. These threads are recommended for general use on thin-wall tubing. The minimum length of complete thread is one-third of the basic major diameter plus 5 threads (+ 0.185 in.).

Selected Combinations: Thread data are tabulated in Table 3 for certain additional selected special combinations of diameter and pitch, with pitch diameter tolerances based on a length of thread engagement of 9 times the pitch. The pitch diameter limits are applicable to a length of engagement of from 5 to 15 times the pitch. (This provision should not be confused with the lengths of thread on mating parts, as they may exceed the length of engagement by a considerable amount.) Thread symbols are UNS and UNRS.

Table 4c. Extra-Fine-Thread Series, UNEF and UNREF — Basic Dimensions

Sizes No. or Inches	Basic Major Dia., <i>D</i> Inches	Thds. per Inch, <i>n</i>	Basic Pitch Dia., ^a <i>D</i> ₂ Inches	Minor Diameter		Lead Angle λ at Basic P.D.		Area of Minor Dia. at $D - 2h_b$ Sq. In.	Tensile Stress Area ^b Sq. In.
				Ext. Thds., ^c <i>d</i> ₃ (Ref.)	Int. Thds., ^d <i>D</i> ₁				
				Inches	Inches	Inches	Deg.		
12 (0.216)^e	0.2160	32	0.1957	0.1788	0.1822	2	55	0.0242	0.0270
$\frac{1}{4}$	0.2500	32	0.2297	0.2128	0.2162	2	29	0.0344	0.0379
$\frac{5}{16}$	0.3125	32	0.2922	0.2753	0.2787	1	57	0.0581	0.0625
$\frac{3}{8}$	0.3750	32	0.3547	0.3378	0.3412	1	36	0.0878	0.0932
$\frac{7}{16}$	0.4375	28	0.4143	0.3949	0.3988	1	34	0.1201	0.1274
$\frac{1}{2}$	0.5000	28	0.4768	0.4574	0.4613	1	22	0.162	0.170
$\frac{9}{16}$	0.5625	24	0.5354	0.5129	0.5174	1	25	0.203	0.214
$\frac{5}{8}$	0.6250	24	0.5979	0.5754	0.5799	1	16	0.256	0.268
$\frac{11}{16}$ ^e	0.6875	24	0.6604	0.6379	0.6424	1	9	0.315	0.329
$\frac{3}{4}$	0.7500	20	0.7175	0.6905	0.6959	1	16	0.369	0.386
$\frac{13}{16}$ ^e	0.8125	20	0.7800	0.7530	0.7584	1	10	0.439	0.458
$\frac{7}{8}$	0.8750	20	0.8425	0.8155	0.8209	1	5	0.515	0.536
$\frac{15}{16}$ ^e	0.9375	20	0.9050	0.8780	0.8834	1	0	0.598	0.620
1	1.0000	20	0.9675	0.9405	0.9459	0	57	0.687	0.711
$\frac{1}{16}$ ^e	1.0625	18	1.0264	0.9964	1.0024	0	59	0.770	0.799
$\frac{1}{8}$	1.1250	18	1.0889	1.0589	1.0649	0	56	0.871	0.901
$\frac{13}{16}$ ^e	1.1875	18	1.1514	1.1214	1.1274	0	53	0.977	1.009
$\frac{1}{4}$	1.2500	18	1.2139	1.1839	1.1899	0	50	1.090	1.123
$\frac{15}{16}$ ^e	1.3125	18	1.2764	1.2464	1.2524	0	48	1.208	1.244
$\frac{3}{8}$	1.3750	18	1.3389	1.3089	1.3149	0	45	1.333	1.370
$\frac{17}{16}$ ^e	1.4375	18	1.4014	1.3714	1.3774	0	43	1.464	1.503
$\frac{1}{2}$	1.5000	18	1.4639	1.4339	1.4399	0	42	1.60	1.64
$\frac{19}{16}$ ^e	1.5625	18	1.5264	1.4964	1.5024	0	40	1.74	1.79
$\frac{5}{8}$	1.6250	18	1.5889	1.5589	1.5649	0	38	1.89	1.94
$\frac{11}{16}$ ^e	1.6875	18	1.6514	1.6214	1.6274	0	37	2.05	2.10

^a British: Effective Diameter.^b See formula, pages 1435 and 1443.^c Design form for UNR threads. (See figure on page 1720.)^d Basic minor diameter.^e Secondary sizes.

Other Threads of Special Diameters, Pitches, and Lengths of Engagement: Thread data for special combinations of diameter, pitch, and length of engagement not included in selected combinations are also given in the Standard but are not given here. Also, when design considerations require non-standard pitches or extreme conditions of engagement not covered by the tables, the allowance and tolerances should be derived from the formulas in the Standard. The thread symbol for such special threads is UNS.

Constant Pitch Series.—The various constant-pitch series, UN, with 4, 6, 8, 12, 16, 20, 28 and 32 threads per inch, given in Table 3, offer a comprehensive range of diameter-pitch combinations for those purposes where the threads in the Coarse, Fine, and Extra-Fine series do not meet the particular requirements of the design.

When selecting threads from these constant-pitch series, preference should be given wherever possible to those tabulated in the 8-, 12-, or 16-thread series.

8-Thread Series: The 8-thread series (8-UN) is a uniform-pitch series for large diameters. Although originally intended for high-pressure-joint bolts and nuts, it is now widely used as a substitute for the Coarse-Thread Series for diameters larger than 1 inch.

12-Thread Series: The 12-thread series (12-UN) is a uniform pitch series for large diameters requiring threads of medium-fine pitch. Although originally intended for boiler practice, it is now used as a continuation of the Fine-Thread Series for diameters larger than $1\frac{1}{2}$ inches.

16-Thread Series: The 16-thread series (16-UN) is a uniform pitch series for large diameters requiring fine-pitch threads. It is suitable for adjusting collars and retaining nuts, and also serves as a continuation of the Extra-fine Thread Series for diameters larger than $1\frac{1}{16}$ inches.

4-, 6-, 20-, 28-, and 32-Thread Series: These thread series have been used more or less widely in industry for various applications where the Standard Coarse, Fine or Extra-fine Series were not as applicable. They are now recognized as Standard Unified Thread Series in a specified selection of diameters for each pitch (see Table 2).

Whenever a thread in a constant-pitch series also appears in the UNC, UNF, or UNEF series, the symbols and tolerances for limits of size of UNC, UNF, or UNEF series are applicable, as will be seen in Tables 2 and 3.

Table 5a. 4-Thread Series, 4-UN and 4-UNR — Basic Dimensions

Sizes		Basic Major Dia., ^a D	Basic Pitch Dia., ^a D_2	Minor Diameter		Lead Angle λ at Basic P.D.		Area of Minor Dia. at $D - 2h_b$	Tensile Stress Area ^b
Primary	Secondary			Ext. Thds., ^c $d_{1.5}$ (Ref.)	Int. Thds., ^d D_1	Deg.	Min.		
Inches	Inches	Inches	Inches	Inches	Inches	Deg.	Min.	Sq. In.	Sq. In.
$2\frac{1}{2}$		2.5000	2.3376	2.2023	2.2294	1	57	3.72	4.00
	$2\frac{5}{8}$	2.6250	2.4626	2.3273	2.3544	1	51	4.16	4.45
$2\frac{3}{4}$		2.7500	2.5876	2.4523	2.4794	1	46	4.62	4.93
	$2\frac{7}{8}$	2.8750	2.7126	2.5773	2.6044	1	41	5.11	5.44
3		3.0000	2.8376	2.7023	2.7294	1	36	5.62	5.97
	$3\frac{1}{8}$	3.1250	2.9626	2.8273	2.8544	1	32	6.16	6.52
$3\frac{1}{4}$		3.2500	3.0876	2.9523	2.9794	1	29	6.72	7.10
	$3\frac{3}{8}$	3.3750	3.2126	3.0773	3.1044	1	25	7.31	7.70
$3\frac{1}{2}$		3.5000	3.3376	3.2023	3.2294	1	22	7.92	8.33
	$3\frac{5}{8}$	3.6250	3.4626	3.3273	3.3544	1	19	8.55	9.00
$3\frac{3}{4}$		3.7500	3.5876	3.4523	3.4794	1	16	9.21	9.66
	$3\frac{7}{8}$	3.8750	3.7126	3.5773	3.6044	1	14	9.90	10.36
4		4.0000	3.8376	3.7023	3.7294	1	11	10.61	11.08
	$4\frac{1}{8}$	4.1250	3.9626	3.8273	3.8544	1	9	11.34	11.83
$4\frac{1}{4}$		4.2500	4.0876	3.9523	3.9794	1	7	12.10	12.61
	$4\frac{3}{8}$	4.3750	4.2126	4.0773	4.1044	1	5	12.88	13.41
$4\frac{1}{2}$		4.5000	4.3376	4.2023	4.2294	1	3	13.69	14.23
	$4\frac{5}{8}$	4.6250	4.4626	4.3273	4.3544	1	1	14.52	15.1
$4\frac{3}{4}$		4.7500	4.5876	4.4523	4.4794	1	0	15.4	15.9
	$4\frac{7}{8}$	4.8750	4.7126	4.5773	4.6044	0	58	16.3	16.8
5		5.0000	4.8376	4.7023	4.7294	0	57	17.2	17.8
	$5\frac{1}{8}$	5.1250	4.9626	4.8273	4.8544	0	55	18.1	18.7
$5\frac{1}{4}$		5.2500	5.0876	4.9523	4.9794	0	54	19.1	19.7
	$5\frac{3}{8}$	5.3750	5.2126	5.0773	5.1044	0	52	20.0	20.7
$5\frac{1}{2}$		5.5000	5.3376	5.2023	5.2294	0	51	21.0	21.7
	$5\frac{5}{8}$	5.6250	5.4626	5.3273	5.3544	0	50	22.1	22.7
$5\frac{3}{4}$		5.7500	5.5876	5.4523	5.4794	0	49	23.1	23.8
	$5\frac{7}{8}$	5.8750	5.7126	5.5773	5.6044	0	48	24.2	24.9
6		6.0000	5.8376	5.7023	5.7294	0	47	25.3	26.0

^aBritish: Effective Diameter.

^bSee formula, pages 1435 and 1443.

^cDesign form for UNR threads. (See figure on page 1720).

^dBasic minor diameter.

^eThese are standard sizes of the UNC series.

Table 5b. 6-Thread Series, 6-UN and 6-UNR—Basic Dimensions

Sizes		Basic Major Dia., <i>D</i>	Basic Pitch Dia., ^a <i>D</i> ₂	Minor Diameter		Lead Angle λ at Basic P.D.	Area of Minor Dia. at $D - 2h_b$	Tensile Stress Area ^b
Primary	Secondary			Ext. Thds., ^c <i>d</i> ₃ (Ref.)	Int. Thds., ^d <i>D</i> ₁			
Inches	Inches	Inches	Inches	Inches	Inches	Deg. Min.	Sq. In.	Sq. In.
1 $\frac{3}{8}$ "		1.3750	1.2667	1.1766	1.1946	2 24	1.054	1.155
	1 $\frac{1}{16}$ "	1.4375	1.3292	1.2391	1.2571	2 17	1.171	1.277
1 $\frac{1}{2}$ "		1.5000	1.3917	1.3016	1.3196	2 11	1.294	1.405
	1 $\frac{1}{16}$ "	1.5625	1.4542	1.3641	1.3821	2 5	1.423	1.54
1 $\frac{5}{8}$ "		1.6250	1.5167	1.4271	1.4446	2 0	1.56	1.68
	1 $\frac{1}{16}$ "	1.6875	1.5792	1.4891	1.5071	1 55	1.70	1.83
1 $\frac{3}{4}$ "		1.7500	1.6417	1.5516	1.5696	1 51	1.85	1.98
	1 $\frac{1}{16}$ "	1.8125	1.7042	1.6141	1.6321	1 47	2.00	2.14
1 $\frac{7}{8}$ "		1.8750	1.7667	1.6766	1.6946	1 43	2.16	2.30
	1 $\frac{1}{16}$ "	1.9375	1.8292	1.7391	1.7571	1 40	2.33	2.47
2"		2.0000	1.8917	1.8016	1.8196	1 36	2.50	2.65
	2 $\frac{1}{8}$ "	2.1250	2.0167	1.9266	1.9446	1 30	2.86	3.03
2 $\frac{1}{4}$ "		2.2500	2.1417	2.0516	2.0696	1 25	3.25	3.42
	2 $\frac{3}{8}$ "	2.3750	2.2667	2.1766	2.1946	1 20	3.66	3.85
2 $\frac{1}{2}$ "		2.5000	2.3917	2.3016	2.3196	1 16	4.10	4.29
	2 $\frac{5}{8}$ "	2.6250	2.5167	2.4266	2.4446	1 12	4.56	4.76
2 $\frac{3}{4}$ "		2.7500	2.6417	2.5516	2.5696	1 9	5.04	5.26
	2 $\frac{7}{8}$ "	2.8750	2.7667	2.6766	2.6946	1 6	5.55	5.78
3"		3.0000	2.8917	2.8016	2.8196	1 3	6.09	6.33
	3 $\frac{1}{8}$ "	3.1250	3.0167	2.9266	2.9446	1 0	6.64	6.89
3 $\frac{1}{4}$ "		3.2500	3.1417	3.0516	3.0696	0 58	7.23	7.49
	3 $\frac{3}{8}$ "	3.3750	3.2667	3.1766	3.1946	0 56	7.84	8.11
3 $\frac{1}{2}$ "		3.5000	3.3917	3.3016	3.3196	0 54	8.47	8.75
	3 $\frac{5}{8}$ "	3.6250	3.5167	3.4266	3.4446	0 52	9.12	9.42
3 $\frac{3}{4}$ "		3.7500	3.6417	3.5516	3.5696	0 50	9.81	10.11
	3 $\frac{7}{8}$ "	3.8750	3.7667	3.6766	3.6946	0 48	10.51	10.83
4"		4.0000	3.8917	3.8016	3.8196	0 47	11.24	11.57
	4 $\frac{1}{8}$ "	4.1250	4.0167	3.9266	3.9446	0 45	12.00	12.33
4 $\frac{1}{4}$ "		4.2500	4.1417	4.0516	4.0696	0 44	12.78	13.12
	4 $\frac{3}{8}$ "	4.3750	4.2667	4.1766	4.1946	0 43	13.58	13.94
4 $\frac{1}{2}$ "		4.5000	4.3917	4.3016	4.3196	0 42	14.41	14.78
	4 $\frac{5}{8}$ "	4.6250	4.5167	4.4266	4.4446	0 40	15.3	15.6
4 $\frac{3}{4}$ "		4.7500	4.6417	4.5516	4.5696	0 39	16.1	16.5
	4 $\frac{7}{8}$ "	4.8750	4.7667	4.6766	4.6946	0 38	17.0	17.5
5"		5.0000	4.8917	4.8016	4.8196	0 37	18.0	18.4
	5 $\frac{1}{8}$ "	5.1250	5.0167	4.9266	4.9446	0 36	18.9	19.3
5 $\frac{1}{4}$ "		5.2500	5.1417	5.0516	5.0696	0 35	19.9	20.3
	5 $\frac{3}{8}$ "	5.3750	5.2667	5.1766	5.1946	0 35	20.9	21.3
5 $\frac{1}{2}$ "		5.5000	5.3917	5.3016	5.3196	0 34	21.9	22.4
	5 $\frac{5}{8}$ "	5.6250	5.5167	5.4266	5.4446	0 33	23.0	23.4
5 $\frac{3}{4}$ "		5.7500	5.6417	5.5516	5.5696	0 32	24.0	24.5
	5 $\frac{7}{8}$ "	5.8750	5.7667	5.6766	5.6946	0 32	25.1	25.6
6"		6.0000	5.8917	5.8016	5.8196	0 31	26.3	26.8

^a British: Effective Diameter.^b See formula, pages 1435 and 1443.^c Design form for UNR threads. (See figure on page 1720).^d Basic minor diameter.^e These are standard sizes of the UNC series.

Table 5c. 8-Thread Series, 8-UN and 8-UNR—Basic Dimensions

Sizes		Basic Major Dia., D	Basic Pitch Dia., $^a D_2$	Minor Diameter		Lead Angle λ at Basic P.D.		Area of Minor Dia. at $D - 2h_b$	Tensile Stress Area ^b
Primary	Secondary			Ext.Thds., ^c d_3 (Ref.)	Int.Thds., ^d D_1	Deg.	Min.		
Inches	Inches	Inches	Inches	Inches	Inches				
1 ^c	1 ¹ / ₁₆	1.0000	0.9188	0.8512	0.8647	2	29	0.551	0.606
		1.0625	0.9813	0.9137	0.9272	2	19	0.636	0.695
1 ¹ / ₈	1 ³ / ₁₆	1.1250	1.0438	0.9792	0.9897	2	11	0.728	0.790
		1.1875	1.1063	1.0387	1.0522	2	4	0.825	0.892
1 ¹ / ₄	1 ⁵ / ₁₆	1.2500	1.1688	1.1012	1.1147	1	57	0.929	1.000
		1.3125	1.2313	1.1637	1.1772	1	51	1.039	1.114
1 ³ / ₈	1 ⁷ / ₁₆	1.3750	1.2938	1.2262	1.2397	1	46	1.155	1.233
		1.4375	1.3563	1.2887	1.3022	1	41	1.277	1.360
1 ¹ / ₂	1 ⁹ / ₁₆	1.5000	1.4188	1.3512	1.3647	1	36	1.405	1.492
		1.5625	1.4813	1.4137	1.4272	1	32	1.54	1.63
1 ⁵ / ₈	1 ¹¹ / ₁₆	1.6250	1.5438	1.4806	1.4897	1	29	1.68	1.78
		1.6875	1.6063	1.5387	1.5522	1	25	1.83	1.93
1 ³ / ₄	1 ¹³ / ₁₆	1.7500	1.6688	1.6012	1.6147	1	22	1.98	2.08
		1.8125	1.7313	1.6637	1.6772	1	19	2.14	2.25
1 ⁷ / ₈	1 ¹⁵ / ₁₆	1.8750	1.7938	1.7262	1.7397	1	16	2.30	2.41
		1.9375	1.8563	1.7887	1.8022	1	14	2.47	2.59
2	2 ¹ / ₈	2.0000	1.9188	1.8512	1.8647	1	11	2.65	2.77
		2.1250	2.0438	1.9762	1.9897	1	7	3.03	3.15
2 ¹ / ₄	2 ³ / ₈	2.2500	2.1688	2.1012	2.1147	1	3	3.42	3.56
		2.3750	2.2938	2.2262	2.2397	1	0	3.85	3.99
2 ¹ / ₂	2 ⁵ / ₈	2.5000	2.4188	2.3512	2.3647	0	57	4.29	4.44
		2.6250	2.5438	2.4762	2.4897	0	54	4.76	4.92
2 ³ / ₄	2 ⁷ / ₈	2.7500	2.6688	2.6012	2.6147	0	51	5.26	5.43
		2.8750	2.7938	2.7262	2.7397	0	49	5.78	5.95
3	3 ¹ / ₈	3.0000	2.9188	2.8512	2.8647	0	47	6.32	6.51
		3.1250	3.0438	2.9762	2.9897	0	45	6.89	7.08
3 ¹ / ₄	3 ³ / ₈	3.2500	3.1688	3.1012	3.1147	0	43	7.49	7.69
		3.3750	3.2938	3.2262	3.2397	0	42	8.11	8.31
3 ¹ / ₂	3 ⁵ / ₈	3.5000	3.4188	3.3512	3.3647	0	40	8.75	8.96
		3.6250	3.5438	3.4762	3.4897	0	39	9.42	9.64
3 ³ / ₄	3 ⁷ / ₈	3.7500	3.6688	3.6012	3.6147	0	37	10.11	10.34
		3.8750	3.7938	3.7262	3.7397	0	36	10.83	11.06
4	4 ¹ / ₈	4.0000	3.9188	3.8512	3.8647	0	35	11.57	11.81
		4.1250	4.0438	3.9762	3.9897	0	34	12.34	12.59
4 ¹ / ₄	4 ³ / ₈	4.2500	4.1688	4.1012	4.1147	0	33	13.12	13.38
		4.3750	4.2938	4.2262	4.2397	0	32	13.94	14.21
4 ¹ / ₂	4 ⁵ / ₈	4.5000	4.4188	4.3512	4.3647	0	31	14.78	15.1
		4.6250	4.5438	4.4762	4.4897	0	30	15.6	15.9
4 ³ / ₄	4 ⁷ / ₈	4.7500	4.6688	4.6012	4.6147	0	29	16.5	16.8
		4.8750	4.7938	4.7262	4.7397	0	29	17.4	17.7
5	5 ¹ / ₈	5.0000	4.9188	4.8512	4.8647	0	28	18.4	18.7
		5.1250	5.0438	4.9762	4.9897	0	27	19.3	19.7
5 ¹ / ₄	5 ³ / ₈	5.2500	5.1688	5.1012	5.1147	0	26	20.3	20.7
		5.3750	5.2938	5.2262	5.2397	0	26	21.3	21.7
5 ¹ / ₂	5 ⁵ / ₈	5.5000	5.4188	5.3512	5.3647	0	25	22.4	22.7
		5.6250	5.5438	5.4762	5.4897	0	25	23.4	23.8
5 ³ / ₄	5 ⁷ / ₈	5.7500	5.6688	5.6012	5.6147	0	24	24.5	24.9
		5.8750	5.7938	5.7262	5.7397	0	24	25.6	26.0
6		6.0000	5.9188	5.8512	5.8647	0	23	26.8	27.1

^a British: Effective Diameter.

^b See formula, pages 1435 and 1443.

^c Design form for UNR threads. (See figure on page 1720).

^d Basic minor diameter.

^e This is a standard size of the UNC series.

Table 5d. 12-Thread series, 12-UN and 12-UNR—Basic Dimensions

Sizes		Basic Major Dia., D	Basic Pitch Dia., ^a D_2	Minor Diameter		Lead Angle λ at Basic P.D.		Area of Minor Dia. at $D - 2h_f$	Tensile Stress Area ^b
Primary	Secondary			Ext. Thds., ^c d_2 (Ref.)	Int. Thds., ^d D_1	Deg.	Min.		
$\frac{9}{16}$		0.5625	0.5084	0.4633	0.4723	2	59	0.162	0.182
$\frac{5}{8}$		0.6250	0.5709	0.5258	0.5348	2	40	0.210	0.232
	$\frac{1}{16}$	0.6875	0.6334	0.5883	0.5973	2	24	0.264	0.289
$\frac{3}{4}$		0.7500	0.6959	0.6508	0.6598	2	11	0.323	0.351
	$\frac{1}{8}$	0.8125	0.7584	0.7133	0.7223	2	0	0.390	0.420
$\frac{7}{8}$		0.8750	0.8209	0.7758	0.7848	1	51	0.462	0.495
	$\frac{1}{8}$	0.9375	0.8834	0.8383	0.8473	1	43	0.540	0.576
1 ^e		1.0000	0.9459	0.9008	0.9098	1	36	0.625	0.663
	$\frac{1}{16}$	1.0625	1.0084	0.9633	0.9723	1	30	0.715	0.756
$1\frac{1}{8}$		1.1250	1.0709	1.0258	1.0348	1	25	0.812	0.856
	$\frac{1}{8}$	1.1875	1.1334	1.0883	1.0973	1	20	0.915	0.961
$1\frac{1}{4}$		1.2500	1.1959	1.1508	1.1598	1	16	1.024	1.073
	$\frac{1}{4}$	1.3125	1.2584	1.2133	1.2223	1	12	1.139	1.191
$1\frac{3}{8}$		1.3750	1.3209	1.2758	1.2848	1	9	1.260	1.315
	$\frac{1}{2}$	1.4375	1.3834	1.3383	1.3473	1	6	1.388	1.445
$1\frac{1}{2}$		1.5000	1.4459	1.4008	1.4098	1	3	1.52	1.58
	$\frac{3}{8}$	1.5625	1.5084	1.4633	1.4723	1	0	1.66	1.72
$1\frac{5}{8}$		1.6250	1.5709	1.5258	1.5348	0	58	1.81	1.87
	$\frac{1}{2}$	1.6875	1.6334	1.5883	1.5973	0	56	1.96	2.03
$1\frac{3}{4}$		1.7500	1.6959	1.6508	1.6598	0	54	2.12	2.19
	$\frac{3}{4}$	1.8125	1.7584	1.7133	1.7223	0	52	2.28	2.35
$1\frac{7}{8}$		1.8750	1.8209	1.7758	1.7848	0	50	2.45	2.53
	$\frac{7}{8}$	1.9375	1.8834	1.8383	1.8473	0	48	2.63	2.71
2		2.0000	1.9459	1.9008	1.9098	0	47	2.81	2.89
	$2\frac{1}{4}$	2.1250	2.0709	2.0258	2.0348	0	44	3.19	3.28
$2\frac{1}{4}$		2.2500	2.1959	2.1508	2.1598	0	42	3.60	3.69
	$2\frac{1}{2}$	2.3750	2.3209	2.2758	2.2848	0	39	4.04	4.13
$2\frac{1}{2}$		2.5000	2.4459	2.4008	2.4098	0	37	4.49	4.60
	$2\frac{3}{4}$	2.6250	2.5709	2.5258	2.5348	0	35	4.97	5.08
$2\frac{3}{4}$		2.7500	2.6959	2.6508	2.6598	0	34	5.48	5.59
	3	2.8750	2.8209	2.7758	2.7848	0	32	6.01	6.13
3		3.0000	2.9459	2.9008	2.9098	0	31	6.57	6.69
	$3\frac{1}{4}$	3.1250	3.0709	3.0258	3.0348	0	30	7.15	7.28
$3\frac{1}{4}$		3.2500	3.1959	3.1508	3.1598	0	29	7.75	7.89
	$3\frac{1}{2}$	3.3750	3.3209	3.2758	3.2848	0	27	8.38	8.52
$3\frac{1}{2}$		3.5000	3.4459	3.4008	3.4098	0	26	9.03	9.18
	$3\frac{3}{4}$	3.6250	3.5709	3.5258	3.5348	0	26	9.71	9.86
$3\frac{3}{4}$		3.7500	3.6959	3.6508	3.6598	0	25	10.42	10.57
	4	3.8750	3.8209	3.7758	3.7848	0	24	11.14	11.30
4		4.0000	3.9459	3.9008	3.9098	0	23	11.90	12.06
	$4\frac{1}{4}$	4.1250	4.0709	4.0258	4.0348	0	22	12.67	12.84
$4\frac{1}{4}$		4.2500	4.1959	4.1508	4.1598	0	22	13.47	13.65
	$4\frac{1}{2}$	4.3750	4.3209	4.2758	4.2848	0	21	14.30	14.48
$4\frac{1}{2}$		4.5000	4.4459	4.4008	4.4098	0	21	15.1	15.3
	$4\frac{3}{4}$	4.6250	4.5709	4.5258	4.5348	0	20	16.0	16.2
$4\frac{3}{4}$		4.7500	4.6959	4.6508	4.6598	0	19	16.9	17.1
	5	4.8750	4.8209	4.7758	4.7848	0	19	17.8	18.0
5		5.0000	4.9459	4.9008	4.9098	0	18	18.8	19.0
	$5\frac{1}{4}$	5.1250	5.0709	5.0258	5.0348	0	18	19.8	20.0
$5\frac{1}{4}$		5.2500	5.1959	5.1508	5.1598	0	18	20.8	21.0
	$5\frac{1}{2}$	5.3750	5.3209	5.2758	5.2848	0	17	21.8	22.0
$5\frac{1}{2}$		5.5000	5.4459	5.4008	5.4098	0	17	22.8	23.1
	$5\frac{3}{4}$	5.6250	5.5709	5.5258	5.5348	0	16	23.9	24.1
$5\frac{3}{4}$		5.7500	5.6959	5.6508	5.6598	0	16	25.0	25.2
	6	5.8750	5.8209	5.7758	5.7848	0	16	26.1	26.4
6		6.0000	5.9459	5.9008	5.9098	0	15	27.3	27.5

^a British: Effective Diameter.^b See formula, pages 1435 and 1443.^c Design form for UNR threads. (See figure on page 1720.)^d Basic minor diameter.^e These are standard sizes of the UNC or UNF Series.

Table 5c. 16-Thread Series, 16-UN and 16-UNR—Basic Dimensions

Sizes		Basic Major Dia., D	Basic Pitch Dia., ^a D_2	Minor Diameter		Lead Angle λ at Basic P.D.		Area of Minor Dia. at $D - 2h_b$	Tensile Stress Area ^b
Primary	Secondary			Ext. Thds., ^c d_3 (Ref.)	Int. Thds., ^d D_1	Deg.	Min.		
		0.3750	0.3344	0.3005	0.3073	3	24	0.0678	0.0775
		0.4375	0.3969	0.3630	0.3698	2	52	0.0997	0.1114
		0.5000	0.4594	0.4255	0.4323	2	29	0.1378	0.151
		0.5625	0.5219	0.4880	0.4948	2	11	0.182	0.198
		0.6250	0.5844	0.5505	0.5573	1	57	0.232	0.250
	11/16	0.6875	0.6469	0.6130	0.6198	1	46	0.289	0.308
		0.7500	0.7094	0.6755	0.6823	1	36	0.351	0.373
	13/16	0.8125	0.7719	0.7380	0.7448	1	29	0.420	0.444
		0.8750	0.8344	0.8005	0.8073	1	22	0.495	0.521
		0.9375	0.8969	0.8630	0.8698	1	16	0.576	0.604
1		1.0000	0.9594	0.9255	0.9323	1	11	0.663	0.693
	11/16	1.0625	1.0219	0.9880	0.9948	1	7	0.756	0.788
1 1/8		1.1250	1.0844	1.0505	1.0573	1	3	0.856	0.889
	13/16	1.1875	1.1469	1.1130	1.1198	1	0	0.961	0.997
1 1/4		1.2500	1.2094	1.1755	1.1823	0	57	1.073	1.111
	15/16	1.3125	1.2719	1.2380	1.2448	0	54	1.191	1.230
1 3/8		1.3750	1.3344	1.3005	1.3073	0	51	1.315	1.356
	17/16	1.4375	1.3969	1.3630	1.3698	0	49	1.445	1.488
1 1/2		1.5000	1.4594	1.4255	1.4323	0	47	1.58	1.63
	19/16	1.5625	1.5219	1.4880	1.4948	0	45	1.72	1.77
1 5/8		1.6250	1.5844	1.5505	1.5573	0	43	1.87	1.92
	111/16	1.6875	1.6469	1.6130	1.6198	0	42	2.03	2.08
1 3/4		1.7500	1.7094	1.6755	1.6823	0	40	2.19	2.24
	131/16	1.8125	1.7719	1.7380	1.7448	0	39	2.35	2.41
1 7/8		1.8750	1.8344	1.8005	1.8073	0	37	2.53	2.58
	115/16	1.9375	1.8969	1.8630	1.8698	0	36	2.71	2.77
2		2.0000	1.9594	1.9255	1.9323	0	35	2.89	2.95
	21/8	2.1250	2.0844	2.0505	2.0573	0	33	3.28	3.35
2 1/4		2.2500	2.2094	2.1755	2.1823	0	31	3.69	3.76
	23/8	2.3750	2.3344	2.3005	2.3073	0	29	4.13	4.21
2 1/2		2.5000	2.4594	2.4255	2.4323	0	28	4.60	4.67
	25/8	2.6250	2.5844	2.5505	2.5573	0	26	5.08	5.16
2 3/4		2.7500	2.7094	2.6755	2.6823	0	25	5.59	5.68
	27/8	2.8750	2.8344	2.8005	2.8073	0	24	6.13	6.22
3		3.0000	2.9594	2.9255	2.9323	0	23	6.69	6.78
	31/8	3.1250	3.0844	3.0505	3.0573	0	22	7.28	7.37
3 1/4		3.2500	3.2094	3.1755	3.1823	0	21	7.89	7.99
	33/8	3.3750	3.3344	3.3005	3.3073	0	21	8.52	8.63
3 1/2		3.5000	3.4594	3.4255	3.4323	0	20	9.18	9.29
	35/8	3.6250	3.5844	3.5505	3.5573	0	19	9.86	9.98
3 3/4		3.7500	3.7094	3.6755	3.6823	0	18	10.57	10.69
	37/8	3.8750	3.8344	3.8005	3.8073	0	18	11.30	11.43
4		4.0000	3.9594	3.9255	3.9323	0	17	12.06	12.19
	41/8	4.1250	4.0844	4.0505	4.0573	0	17	12.84	12.97
4 1/4		4.2500	4.2094	4.1755	4.1823	0	16	13.65	13.78
	43/8	4.3750	4.3344	4.3005	4.3073	0	16	14.48	14.62
4 1/2		4.5000	4.4594	4.4255	4.4323	0	15	15.34	15.5
	45/8	4.6250	4.5844	4.5505	4.5573	0	15	16.2	16.4
4 3/4		4.7500	4.7094	4.6755	4.6823	0	15	17.1	17.3
	47/8	4.8750	4.8344	4.8005	4.8073	0	14	18.0	18.2
5		5.0000	4.9594	4.9255	4.9323	0	14	19.0	19.2
	51/8	5.1250	5.0844	5.0505	5.0573	0	13	20.0	20.1
5 1/4		5.2500	5.2094	5.1755	5.1823	0	13	21.0	21.1
	53/8	5.3750	5.3344	5.3005	5.3073	0	13	22.0	22.2

Table 5e. (Continued) 16-Thread Series, 16-UN and 16-UNR—Basic Dimensions

Sizes		Basic Major Dia., D	Basic Pitch Dia., ^a D_2	Minor Diameter		Lead Angle λ at Basic P.D.		Area of Minor Dia. at $D - 2h_b$	Tensile Stress Area ^b
Primary	Secondary			Ext. Thds., ^c d_3 (Ref.)	Int. Thds., ^d D_1	Deg.	Min.		
5½		5.5000	5.4594	5.4255	5.4323	0	13	23.1	23.2
	5⅝	5.6250	5.5844	5.5505	5.5573	0	12	24.1	24.3
5¾		5.7500	5.7094	5.6755	5.6823	0	12	25.2	25.4
	5⅞	5.8750	5.8344	5.8005	5.8073	0	12	26.4	26.5
6		6.0000	5.9594	5.9255	5.9323	0	11	27.5	27.7

^a British: Effective Diameter.^b See formula, pages 1435 and 1443.^c Design form for UNR threads. (See figure on page 1720.)^d Basic minor diameter.^e These are standard sizes of the UNC or UNF Series.**Table 5f. 20-Thread Series, 20-UN and 20-UNR—Basic Dimensions**

Sizes		Basic Major Dia., D	Basic Pitch Dia., ^a D_2	Minor Diameter		Lead Angle λ at Basic P.D.		Area of Minor Dia. at $D - 2h_b$	Tensile Stress Area ^b
Primary	Secondary			Ext. Thds., ^c d_3 (Ref.)	Int. Thds., ^d D_1	Deg.	Min.		
1/4		0.2500	0.2175	0.1905	0.1959	4	11	0.0269	0.0318
5/16		0.3125	0.2800	0.2530	0.2584	3	15	0.0481	0.0547
3/8		0.3750	0.3425	0.3155	0.3209	2	40	0.0755	0.0836
7/16 ^e		0.4375	0.4050	0.3780	0.3834	2	15	0.1090	0.1187
1/2 ^e		0.5000	0.4675	0.4405	0.4459	1	57	0.1486	0.160
9/16 ^e		0.5625	0.5300	0.5030	0.5084	1	43	0.194	0.207
5/8		0.6250	0.5925	0.5655	0.5709	1	32	0.246	0.261
	11/16	0.6875	0.6550	0.6280	0.6334	1	24	0.304	0.320
3/4 ^e		0.7500	0.7175	0.6905	0.6959	1	16	0.369	0.386
	13/16 ^e	0.8125	0.7800	0.7530	0.7584	1	10	0.439	0.458
7/8 ^e		0.8750	0.8425	0.8155	0.8209	1	5	0.515	0.536
	15/16 ^e	0.9375	0.9050	0.8780	0.8834	1	0	0.0.598	0.620
1 ^e		1.0000	0.9675	0.9405	0.9459	0	57	0.687	0.711
	1 1/16	1.0625	1.0300	1.0030	1.0084	0	53	0.782	0.807
1 1/8		1.1250	1.0925	1.0655	1.0709	0	50	0.882	0.910
	1 3/16	1.1875	1.1550	1.1280	1.1334	0	47	0.990	1.018
1 1/4		1.2500	1.2175	1.1905	1.1959	0	45	1.103	1.133
	1 5/16	1.3125	1.2800	1.2530	1.2584	0	43	1.222	1.254
1 3/8		1.3750	1.3425	1.3155	1.3209	0	41	1.348	1.382
	1 7/16	1.4375	1.4050	1.3780	1.3834	0	39	1.479	1.51
1 1/2		1.5000	1.4675	1.4405	1.4459	0	37	1.62	1.65
	1 9/16	1.5625	1.5300	1.5030	1.5084	0	36	1.76	1.80
1 5/8		1.6250	1.5925	1.5655	1.5709	0	34	1.91	1.95
	1 11/16	1.6875	1.6550	1.6280	1.6334	0	33	2.07	2.11
1 3/4		1.7500	1.7175	1.6905	1.6959	0	32	2.23	2.27
	1 13/16	1.8125	1.7800	1.7530	1.7584	0	31	2.40	2.44
1 7/8		1.8750	1.8425	1.8155	1.8209	0	30	2.57	2.62
	1 15/16	1.9375	1.9050	1.8780	1.8834	0	29	2.75	2.80
2		2.0000	1.9675	1.9405	1.9459	0	28	2.94	2.99
	2 1/8	2.1250	2.0925	2.0655	2.0709	0	26	3.33	3.39
2 1/4		2.2500	2.2175	2.1905	2.1959	0	25	3.75	3.81
	2 3/8	2.3750	2.3425	2.3155	2.3209	0	23	4.19	4.25
2 1/2		2.5000	2.4675	2.4405	2.4459	0	22	4.66	4.72
	2 5/8	2.6250	2.5925	2.5655	2.5709	0	21	5.15	5.21
2 3/4		2.7500	2.7175	2.6905	2.6959	0	20	5.66	5.73
	2 7/8	2.8750	2.8425	2.8155	2.8209	0	19	6.20	6.27
3		3.0000	2.9675	2.9405	2.9459	0	18	6.77	6.84

^a British: Effective Diameter.^b See formula, pages 1435 and 1443.^c Design form for UNR threads. (See figure on page 1720.)^d Basic minor diameter.^e These are standard sizes of the UNC, UNF, or UNEF Series.

Table 5g. 28-Thread Series, 28-UN and 28-UNR — Basic Dimensions

Sizes		Basic Major Dia., D	Basic Pitch Dia., ^a D_2	Minor Diameter		Lead Angel λ at Basic P.D.		Area of Minor Dia. at $D - 2h_b$	Tensile Stress Area ^b	
Primary	Secondary			Ext. Thds., ^c d_3 (Ref.)	Int. Thds., ^d D_1	Deg.	Min.			Sq. In.
Inches	Inches	Inches	Inches	Inches	Inches	Deg.	Min.	Sq. In.	Sq. In.	
$\frac{1}{8}$	12 (0.216) ^e	0.2160	0.1928	0.1734	0.1773	3	22	0.0226	0.0258	
		0.2500	0.2268	0.2074	0.2113	2	52	0.0326	0.0364	
$\frac{5}{16}$	12 (0.216) ^e	0.3125	0.2893	0.2699	0.2738	2	15	0.0556	0.0606	
$\frac{3}{8}$		0.3750	0.3518	0.3324	0.3363	1	51	0.0848	0.0909	
$\frac{7}{16}$		0.4375	0.4143	0.3949	0.3988	1	34	0.1201	0.1274	
$\frac{1}{2}$		0.5000	0.4768	0.4574	0.4613	1	22	0.162	0.170	
$\frac{9}{16}$		0.5625	0.5393	0.5199	0.5238	1	12	0.209	0.219	
$\frac{5}{8}$		0.6250	0.6018	0.5824	0.5863	1	5	0.263	0.274	
$\frac{3}{4}$		$\frac{11}{16}$	0.6875	0.6643	0.6449	0.6488	0	59	0.323	0.335
		$\frac{13}{16}$	0.7500	0.7268	0.7074	0.7113	0	54	0.389	0.402
$\frac{7}{8}$		$\frac{13}{16}$	0.8125	0.7893	0.7699	0.7738	0	50	0.461	0.474
		$\frac{15}{16}$	0.8750	0.8518	0.8324	0.8363	0	46	0.539	0.554
1	$\frac{15}{16}$	0.9375	0.9143	0.8949	0.8988	0	43	0.624	0.640	
	$\frac{17}{16}$	1.0000	0.9768	0.9574	0.9613	0	40	0.714	0.732	
$1\frac{1}{8}$	$\frac{17}{16}$	1.0625	1.0393	1.0199	1.0238	0	38	0.811	0.830	
	$\frac{19}{16}$	1.1250	1.1018	1.0824	1.0863	0	35	0.914	0.933	
$1\frac{1}{4}$	$\frac{19}{16}$	1.1875	1.1643	1.1449	1.1488	0	34	1.023	1.044	
	$\frac{21}{16}$	1.2500	1.2268	1.2074	1.2113	0	32	1.138	1.160	
$1\frac{3}{8}$	$\frac{21}{16}$	1.3125	1.2893	1.2699	1.2738	0	30	1.259	1.282	
	$\frac{23}{16}$	1.3750	1.3518	1.3324	1.3363	0	29	1.386	1.411	
$1\frac{1}{2}$	$\frac{23}{16}$	1.4375	1.4143	1.3949	1.3988	0	28	1.52	1.55	
	$\frac{25}{16}$	1.5000	1.4768	1.4574	1.4613	0	26	1.66	1.69	

^a British: Effective Diameter.

^b See formula, pages 1435 and 1443.

^c Design form for UNR threads. (See figure on page 1720.)

^d Basic minor diameter.

^e These are standard sizes of the UNF or UNEF Series.

Table 5h. 32-Thread Series, 32-UN and 32-UNR — Basic Dimensions

Sizes		Basic Major Dia., D	Basic Pitch Dia., ^a D_2	Minor Diameter		Lead Angel λ at Basic P.D.		Area of Minor Dia. at $D - 2h_b$	Tensile Stress Area ^b	
Primary	Secondary			Ext. Thds., ^c d_3 (Ref.)	Int. Thds., ^d D_1	Deg.	Min.			Sq. In.
Inches	Inches	Inches	Inches	Inches	Inches	Deg.	Min.	Sq. In.	Sq. In.	
6 (0.138) ^e	12 (0.216) ^e	0.1380	0.1177	0.1008	0.1042	4	50	0.00745	0.00909	
8 (0.164) ^e		0.1640	0.1437	0.1268	0.1302	3	58	0.01196	0.0140	
10 (0.190) ^e		0.1900	0.1697	0.1528	0.1562	3	21	0.01750	0.0200	
$\frac{1}{4}$		0.2160	0.1957	0.1788	0.1822	2	55	0.0242	0.0270	
		0.2500	0.2297	0.2128	0.2162	2	29	0.0344	0.0379	
$\frac{5}{16}$		0.3125	0.2922	0.2753	0.2787	1	57	0.0581	0.0625	
$\frac{3}{8}$		0.3750	0.3547	0.3378	0.3412	1	36	0.0878	0.0932	
$\frac{7}{16}$		0.4375	0.4172	0.4003	0.4037	1	22	0.1237	0.1301	
$\frac{1}{2}$		0.5000	0.4797	0.4628	0.4662	1	11	0.166	0.173	
$\frac{9}{16}$		0.5625	0.5422	0.5253	0.5287	1	3	0.214	0.222	
$\frac{5}{8}$		0.6250	0.6047	0.5878	0.5912	0	57	0.268	0.278	
$\frac{3}{4}$		$\frac{11}{16}$	0.6875	0.6672	0.6503	0.6537	0	51	0.329	0.339
		$\frac{13}{16}$	0.7500	0.7297	0.7128	0.7162	0	47	0.395	0.407
$\frac{7}{8}$		$\frac{13}{16}$	0.8125	0.7922	0.7753	0.7787	0	43	0.468	0.480
		$\frac{15}{16}$	0.8750	0.8547	0.8378	0.8412	0	40	0.547	0.560
1		$\frac{15}{16}$	0.9375	0.9172	0.9003	0.9037	0	37	0.632	0.646
	$\frac{17}{16}$	1.0000	0.9797	0.9628	0.9662	0	35	0.723	0.738	

^a British: Effective Diameter.

^b See formula, pages 1435 and 1443.

^c Design form for UNR threads. (See figure on page 1720.)

^d Basic minor diameter.

^e These are standard sizes of the UNC, UNF, or UNEF Series.

Thread Classes.—Thread classes are distinguished from each other by the amounts of tolerance and allowance. Classes identified by a numeral followed by the letters A and B are derived from certain Unified formulas (not shown here) in which the pitch diameter tolerances are based on increments of the basic major (nominal) diameter, the pitch, and the length of engagement. These formulas and the class identification or symbols apply to all of the Unified threads.

Classes 1A, 2A, and 3A apply to external threads only, and Classes 1B, 2B, and 3B apply to internal threads only. The disposition of the tolerances, allowances, and crest clearances for the various classes is illustrated on page 1761.

Classes 2A and 2B: Classes 2A and 2B are the most commonly used for general applications, including production of bolts, screws, nuts, and similar fasteners.

The maximum diameters of Class 2A (external) uncoated threads are less than basic by the amount of the allowance. The allowance minimizes galling and seizing in high-cycle wrench assembly, or it can be used to accommodate plated finishes or other coating. However, for threads with additive finish, the maximum diameters of Class 2A may be exceeded by the amount of the allowance, for example, the 2A maximum diameters apply to an unplated part or to a part before plating whereas the basic diameters (the 2A maximum diameter plus allowance) apply to a part after plating. The minimum diameters of Class 2B (internal) threads, whether or not plated or coated, are basic, affording no allowance or clearance in assembly at maximum metal limits.

Class 2AG: Certain applications require an allowance for rapid assembly to permit application of the proper lubricant or for residual growth due to high-temperature expansion. In these applications, when the thread is coated and the 2A allowance is not permitted to be consumed by such coating, the thread class symbol is qualified by G following the class symbol.

Classes 3A and 3B: Classes 3A and 3B may be used if closer tolerances are desired than those provided by Classes 2A and 2B. The maximum diameters of Class 3A (external) threads and the minimum diameters of Class 3B (internal) threads, whether or not plated or coated, are basic, affording no allowance or clearance for assembly of maximum metal components.

Classes 1A and 1B: Classes 1A and 1B threads replaced American National Class 1. These classes are intended for ordnance and other special uses. They are used on threaded components where quick and easy assembly is necessary and where a liberal allowance is required to permit ready assembly, even with slightly bruised or dirty threads.

Maximum diameters of Class 1A (external) threads are less than basic by the amount of the same allowance as applied to Class 2A. For the intended applications in American practice the allowance is not available for plating or coating. Where the thread is plated or coated, special provisions are necessary. The minimum diameters of Class 1B (internal) threads, whether or not plated or coated, are basic, affording no allowance or clearance for assembly with maximum metal external thread components having maximum diameters which are basic.

Coated 60-deg. Threads.—Although the Standard does not make recommendations for thicknesses of, or specify limits for coatings, it does outline certain principles that will aid mechanical interchangeability if followed whenever conditions permit.

To keep finished threads within the limits of size established in the Standard, external threads should not exceed basic size after plating and internal threads should not be below basic size after plating. This recommendation does not apply to threads coated by certain commonly used processes such as hot-dip galvanizing where it may not be required to maintain these limits.

Class 2A provides both a tolerance and an allowance. Many thread requirements call for coatings such as those deposited by electro-plating processes and, in general, the 2A allow-

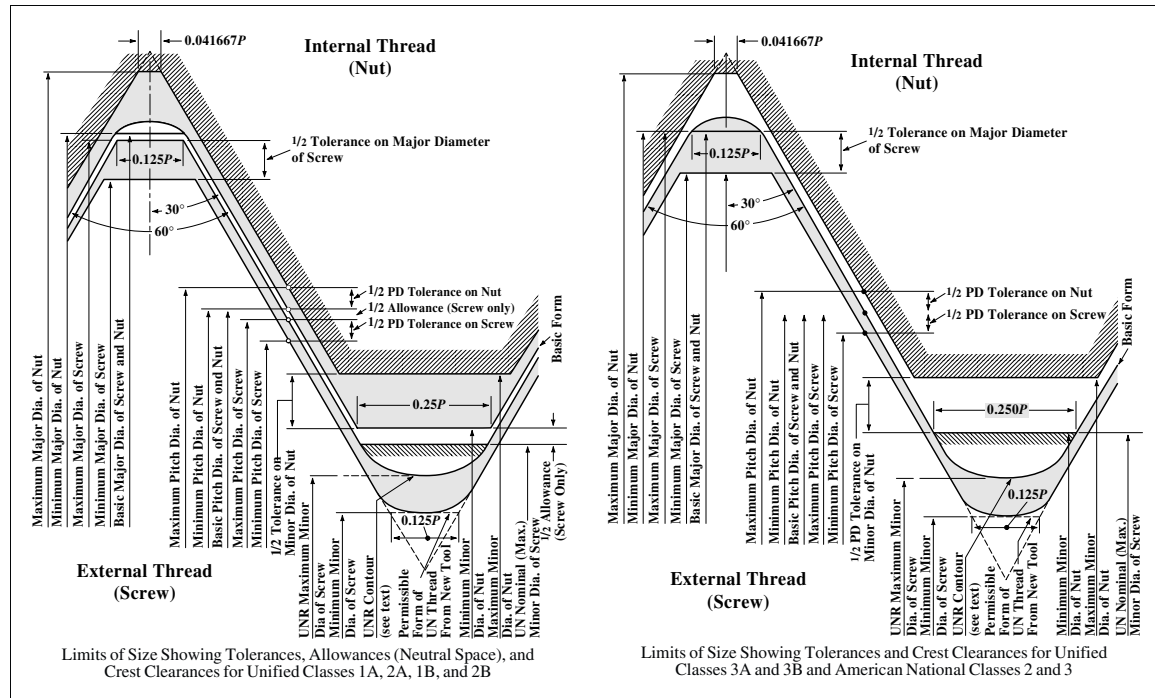

ance provides adequate undercut for such coatings. There may be variations in thickness and symmetry of coating resulting from commercial processes but after plating the threads should be accepted by a basic Class 3A size GO gage and a Class 2A gage as a NOT-GO gage. Class 1A provides an allowance which is maintained for both coated and uncoated product, i.e., it is not available for coating.

Class 3A does not include an allowance so it is suggested that the limits of size before plating be reduced by the amount of the 2A allowance whenever that allowance is adequate.

No provision is made for overcutting internal threads as coatings on such threads are not generally required. Further, it is very difficult to deposit a significant thickness of coating on the flanks of internal threads. Where a specific thickness of coating is required on an internal thread, it is suggested that the thread be overcut so that the thread as coated will be accepted by a GO thread plug gage of basic size.

This Standard ASME/ANSI B1.1-1989 (R2001) specifies limits of size that pertain whether threads are coated or uncoated. Only in Class 2A threads is an allowance available to accommodate coatings. Thus, in all classes of internal threads and in all Class 1A, 2AG, and 3A external threads, limits of size must be adjusted to provide suitable provision for the desired coating.

For further information concerning dimensional accommodation of coating or plating for 60-degree threads, see Section 7, ASME/ANSI B1.1-1989 (R2001).

Screw Thread Selection — Combination of Classes.—Whenever possible, selection should be made from [Table 2](#), Standard Series Unified Screw Threads, preference being given to the Coarse- and Fine- thread Series. If threads in the standard series do not meet the requirements of design, reference should be made to the selected combinations in [Table 3](#). The third expedient is to compute the limits of size from the tolerance tables or tolerance increment tables given in the Standard. The fourth and last resort is calculation by the formulas given in the Standard.

The requirements for screw thread fits for specific applications depend on end use and can be met by specifying the proper combinations of thread classes for the components. For example, a Class 2A external thread may be used with a Class 1B, 2B, or 3B internal thread.

Pitch Diameter Tolerances, All Classes.—The pitch diameter tolerances in [Table 3](#) for all classes of the UNC, UNF, 4-UN, 6-UN, and 8-UN series are based on a length of engagement equal to the basic major (nominal) diameter and are applicable for lengths of engagement up to $1\frac{1}{2}$ diameters.

The pitch diameter tolerances used in [Table 3](#) for all classes of the UNEF, 12-UN, 16-UN, 20-UN, 28-UN, and 32-UN series and the UNS series, are based on a length of engagement of 9 pitches and are applicable for lengths of engagement of from 5 to 15 pitches.

Screw Thread Designation.—The basic method of designating a screw thread is used where the standard tolerances or limits of size based on the standard length of engagement are applicable. The designation specifies in sequence the nominal size, number of threads per inch, thread series symbol, thread class symbol, and the gaging system number per ASME/ANSI B1.3M. The nominal size is the basic major diameter and is specified as the fractional diameter, screw number, or their decimal equivalent. Where decimal equivalents are used for size callout, they shall be interpreted as being nominal size designations only and shall have no dimensional significance beyond the fractional size or number designation. The symbol LH is placed after the thread class symbol to indicate a left-hand thread:

Examples:

$\frac{1}{4}$ -20 UNC-2A (21) or 0.250-20 UNC-2A (21)

10–32 UNF-2A (22) or 0.190–32 UNF-2A (22)

$\frac{7}{16}$ –20 UNRF-2A (23) or 0.4375–20 UNRF-2A (23)

2–12 UN-2A (21) or 2.000–12 UN-2A (21)

$\frac{1}{4}$ –20 UNC-3A-LH (21) or 0.250–20 UNC-3A-LH (21)

For uncoated standard series threads these designations may optionally be supplemented by the addition of the pitch diameter limits of size.

Example:

$\frac{1}{4}$ –20 UNC-2A (21)

PD 0.2164–0.2127 (Optional for uncoated threads)

Designating Coated Threads.—For coated (or plated) Class 2A external threads, the basic (max) major and basic (max) pitch diameters are given followed by the words AFTER COATING. The major and pitch diameter limits of size before coating are also given followed by the words BEFORE COATING.

Example:

$\frac{3}{4}$ –10 UNC-2A (21)

^aMajor dia 0.7500 max

PD 0.6850 max

^bMajor dia 0.7482–0.7353

PD 0.6832–0.6773

} AFTER COATING

} BEFORE COATING

^aMajor and PD values are equal to basic and correspond to those in Table 3 for Class 3A.

^bMajor and PD limits are those in Table 3 for Class 2A.

Certain applications require an allowance for rapid assembly, to permit application of a proper lubricant, or for residual growth due to high-temperature expansion. In such applications where the thread is to be coated and the 2A allowance is not permitted to be consumed by such coating, the thread class symbol is qualified by the addition of the letter G (symbol for allowance) following the class symbol, and the maximum major and maximum pitch diameters are reduced below basic size by the amount of the 2A allowance and followed by the words AFTER COATING. This arrangement ensures that the allowance is maintained. The major and pitch diameter limits of size before coating are also given followed by SPL and BEFORE COATING. For information concerning the designating of this and other special coating conditions reference should be made to American National Standard ASME/ANSI B 1.1-1989 (R2001).

Designating UNS Threads.—UNS screw threads that have special combinations of diameter and pitch with tolerance to Unified formulation have the basic form designation set out first followed always by the limits of size.

Designating Multiple Start Threads.—If a screw thread is of multiple start, it is designated by specifying in sequence the nominal size, pitch (in decimals or threads per inch) and lead (in decimals or fractions).

Other Special Designations.—For other special designations including threads with modified limits of size or with special lengths of engagement, reference should be made to American National Standard ASME/ANSI B 1.1-1989 (R2001).

Hole Sizes for Tapping.—Hole size limits for tapping Classes 1B, 2B, and 3B threads of various lengths of engagement are given in Table 2 on page 1926.

Internal Thread Minor Diameter Tolerances.—Internal thread minor diameter tolerances in Table 3 are based on a length of engagement equal to the nominal diameter. For general applications these tolerances are suitable for lengths of engagement up to $1\frac{1}{2}$ diameters. However, some thread applications have lengths of engagement which are greater than $1\frac{1}{2}$ diameters or less than the nominal diameter. For such applications it may be advantageous to increase or decrease the tolerance, respectively, as explained in the Tapping Section.

American Standard for Unified Miniature Screw Threads

This American Standard (B1.10-1958, R1988) introduces a new series to be known as Unified Miniature Screw Threads and intended for general purpose fastening screws and similar uses in watches, instruments, and miniature mechanisms. Use of this series is recommended on all new products in place of the many improvised and unsystematized sizes now in existence which have never achieved broad acceptance nor recognition by standardization bodies. The series covers a diameter range from 0.30 to 1.40 millimeters (0.0118 to 0.0551 inch) and thus supplements the Unified and American thread series which begins at 0.060 inch (number 0 of the machine screw series). It comprises a total of fourteen sizes which, together with their respective pitches, are those endorsed by the American-British-Canadian Conference of April 1955 as the basis for a Unified standard among the inch-using countries, and coincide with the corresponding range of sizes in ISO (International Organization for Standardization) Recommendation No. 68. Additionally, it utilizes thread forms which are compatible in all significant respects with both the Unified and ISO basic thread profiles. Thus, threads in this series are interchangeable with the corresponding sizes in both the American-British-Canadian and ISO standardization programs.

Basic Form of Thread.—The basic profile by which the design forms of the threads covered by this standard are governed is shown in **Table 1**. The thread angle is 60 degrees and except for basic height and depth of engagement which are $0.52p$, instead of $0.54127p$, the basic profile for this thread standard is identical with the Unified and American basic thread form. The selection of 0.52 as the exact value of the coefficient for the height of this basic form is based on practical manufacturing considerations and a plan evolved to simplify calculations and achieve more precise agreement between the metric and inch dimensional tables.

Products made to this standard will be interchangeable with products made to other standards which allow a maximum depth of engagement (or combined addendum height) of $0.54127p$. The resulting difference is negligible (only 0.00025 inch for the coarsest pitch) and is completely offset by practical considerations in tapping, since internal thread heights exceeding $0.52p$ are avoided in these (Unified Miniature) small thread sizes in order to reduce excessive tap breakage.

Design Forms of Threads.—The design (maximum material) forms of the external and internal threads are shown in **Table 2**. These forms are derived from the basic profile shown in **Table 1** by the application of clearances for the crests of the addenda at the roots of the mating dedendum forms. Basic and design form dimensions are given in **Table 3**.

Nominal Sizes: The thread sizes comprising this series and their respective pitches are shown in the first two columns of **Table 5**. The fourteen sizes shown in **Table 5** have been systematically distributed to provide a uniformly proportioned selection over the entire range. They are separated alternately into two categories: The sizes shown in bold type are selections made in the interest of simplification and are those to which it is recommended that usage be confined wherever the circumstances of design permit. Where these sizes do not meet requirements the intermediate sizes shown in light type are available.

Table 1. Unified Miniature Screw Threads — Basic Thread Form

Formulas for Basic Thread Form Metric units (millimeters) are used in all formulas		
Thread Element	Symbol	Formula
Angle of thread	2α	60°
Half angle of thread	α	30°
Pitch of thread	p	
No. of threads per inch	n	$25.4/p$
Height of sharp V thread	H	$0.86603p$
Addendum of basic thread	h_{ab}	$0.32476p$
Height of basic thread	h_b	$0.52p$

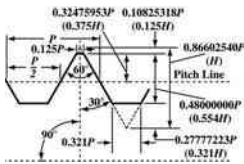
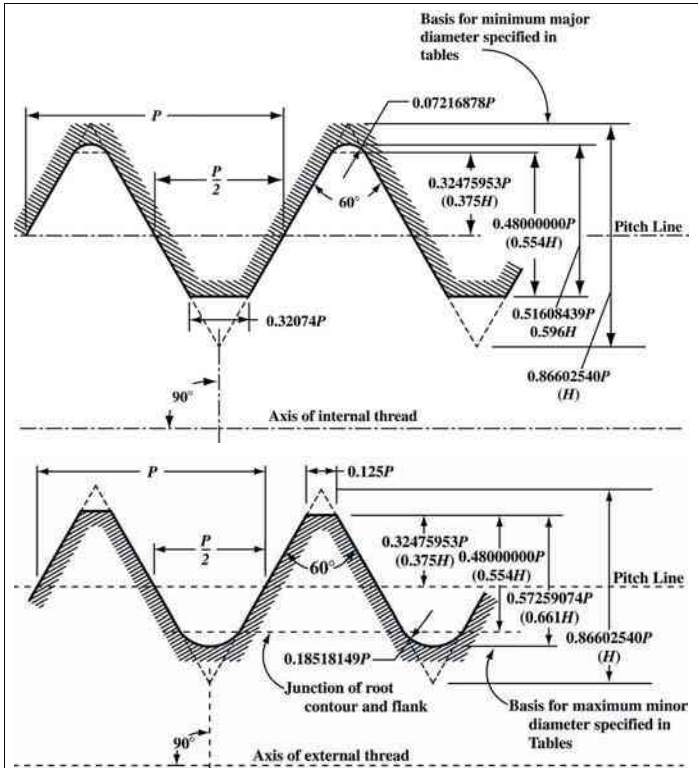

Table 2. Unified Miniature Screw Threads — Design Thread Form



Formulas for Design Thread Form (maximum material)^a

External Thread			Internal Thread		
Thread Element	Symbol	Formula	Thread Element	Symbol	Formula
Addendum	h_{as}	$0.32476p$	Height of engagement	h_e	$0.52p$
Height	h_s	$0.60p$	Height of thread	h_n	$0.556p$
Flat at crest	F_{cs}	$0.125p$	Flat at crest	F_{cn}	$0.27456p$
Radius at root	r_{rs}	$0.158p$ (approx)	Radius at root	r_m	$0.072p$ (approx)

^a Metric units (millimeters) are used in all formulas.

Table 3. Unified Miniature Screw Threads—Basic and Design Form Dimensions

Basic Thread Form					External Thread Design Form			Internal Thread Design Form		
Threads per inch n^a	Pitch p	Height of Sharp V $H = 0.86603p$	Height $h_b = 0.52p$	Addendum $h_{ab} = h_{as} = 0.32476p$	Height $h_s = 0.60p$	Flat at Crest $F_{cs} = 0.125p$	Radius at Root $r_{rs} = 0.158p$	Height $h_n = 0.556p$	Flat at Crest $F_{cn} = 0.27456p$	Radius at Root $r_{rn} = 0.072p$
Millimeter Dimensions										
...	.080	.0693	.0416	.0260	.048	.0100	.0126	.0445	.0220	.0058
...	.090	.0779	.0468	.0292	.054	.0112	.0142	.0500	.0247	.0065
...	.100	.0866	.0520	.0325	.060	.0125	.0158	.0556	.0275	.0072
...	.125	.1083	.0650	.0406	.075	.0156	.0198	.0695	.0343	.0090
...	.150	.1299	.0780	.0487	.090	.0188	.0237	.0834	.0412	.0108
...	.175	.1516	.0910	.0568	.105	.0219	.0277	.0973	.0480	.0126
...	.200	.1732	.1040	.0650	.120	.0250	.0316	.1112	.0549	.0144
...	.225	.1949	.1170	.0731	.135	.0281	.0356	.1251	.0618	.0162
...	.250	.2165	.1300	.0812	.150	.0312	.0395	.1390	.0686	.0180
...	.300	.2598	.1560	.0974	.180	.0375	.0474	.1668	.0824	.0216
Inch Dimensions										
317½	.003150	.00273	.00164	.00102	.00189	.00039	.00050	.00175	.00086	.00023
282⅝	.003543	.00307	.00184	.00115	.00213	.00044	.00056	.00197	.00097	.00026
254	.003937	.00341	.00205	.00128	.00236	.00049	.00062	.00219	.00108	.00028
203½	.004921	.00426	.00256	.00160	.00295	.00062	.00078	.00274	.00135	.00035
169⅝	.005906	.00511	.00307	.00192	.00354	.00074	.00093	.00328	.00162	.00043
145⅝	.006890	.00597	.00358	.00224	.00413	.00086	.00109	.00383	.00189	.00050
127	.007874	.00682	.00409	.00256	.00472	.00098	.00124	.00438	.00216	.00057
112⅝	.008858	.00767	.00461	.00288	.00531	.00111	.00140	.00493	.00243	.00064
101⅝	.009843	.00852	.00512	.00320	.00591	.00123	.00156	.00547	.00270	.00071
84⅝	.011811	.01023	.00614	.00384	.00709	.00148	.00187	.00657	.00324	.00085

^a In Tables 5 and 6 these values are shown rounded to the nearest whole number.

Table 4. Unified Miniature Screw Threads — Formulas for Basic and Design Dimensions and Tolerances

Formulas for Basic Dimensions	
D = Basic Major Diameter and Nominal Size in millimeters; p = Pitch in millimeters; E = Basic Pitch Diameter in millimeters = $D - 0.64952p$; and K = Basic Minor Diameter in millimeters = $D - 1.04p$	
Formulas for Design Dimensions (Maximum Material)	
External Thread	Internal Thread
D_s = Major Diameter = D	D_n = Major Diameter = $D + 0.072p$
E_s = Pitch Diameter = E	E_n = Pitch Diameter = E
K_s = Minor Diameter = $D - 1.20p$	K_n = Minor Diameter = K
Formulas for Tolerances on Design Dimensions ^a	
External Thread (-)	Internal Thread (+)
Major Diameter Tol., $0.12p + 0.006$	^b Major Diameter Tol., $0.168p + 0.008$
Pitch Diameter Tol., $0.08p + 0.008$	Pitch Diameter Tol., $0.08p + 0.008$
^c Minor Diameter Tol., $0.16p + 0.008$	Minor Diameter Tol., $0.32p + 0.012$

^a These tolerances are based on lengths of engagement of $\frac{2}{3}D$ to $1\frac{1}{2}D$.

^b This tolerance establishes the maximum limit of the major diameter of the internal thread. In practice, this limit is applied to the threading tool (tap) and not gaged on the product. Values for this tolerance are, therefore, not given in Table 5.

^c This tolerance establishes the minimum limit of the minor diameter of the external thread. In practice, this limit is applied to the threading tool and only gaged on the product in confirming new tools. Values for this tolerance are, therefore, not given in Table 5.

Metric units (millimeters) apply in all formulas. Inch tolerances are not derived by direct conversion of the metric values. They are the differences between the rounded off limits of size in inch units.

Table 5. Unified Miniature Screw Threads — Limits of Size and Tolerances

Size Designation ^a	Pitch mm	External Threads						Internal Threads						Lead Angle at Basic Pitch Diam.		Sectional Area at Minor Diam. at D — 1.28p sq mm
		Major Diam.		Pitch Diam.		Minor Diam.		Minor Diam.		Pitch Diam.		Major Diam.				
		Max ^b mm	Min mm	Max ^b mm	Min mm	Max ^c mm	Min ^d mm	Min ^b mm	Max mm	Min ^b mm	Max mm	Min ^c mm	Max ^d mm	deg	min	sq in
0.30 UNM	0.080	0.300	0.284	0.248	0.234	0.204	0.183	0.217	0.254	0.248	0.262	0.306	0.327	5	52	0.0307
0.35 UNM	0.090	0.350	0.333	0.292	0.277	0.242	0.220	0.256	0.297	0.292	0.307	0.356	0.380	5	37	0.0433
0.40 UNM	0.100	0.400	0.382	0.335	0.319	0.280	0.256	0.296	0.340	0.335	0.351	0.407	0.432	5	26	0.0581
0.45 UNM	0.100	0.450	0.432	0.385	0.369	0.330	0.306	0.346	0.390	0.385	0.401	0.457	0.482	4	44	0.0814
0.50 UNM	0.125	0.500	0.479	0.419	0.401	0.350	0.322	0.370	0.422	0.419	0.437	0.509	0.538	5	26	0.0908
0.55 UNM	0.125	0.550	0.529	0.469	0.451	0.400	0.372	0.420	0.472	0.469	0.487	0.559	0.588	4	51	0.1195
0.60 UNM	0.150	0.600	0.576	0.503	0.483	0.420	0.388	0.444	0.504	0.503	0.523	0.611	0.644	5	26	0.1307
0.70 UNM	0.175	0.700	0.673	0.586	0.564	0.490	0.454	0.518	0.586	0.586	0.608	0.713	0.750	5	26	0.1780
0.80 UNM	0.200	0.800	0.770	0.670	0.646	0.560	0.520	0.592	0.668	0.670	0.694	0.814	0.856	5	26	0.232
0.90 UNM	0.225	0.900	0.867	0.754	0.728	0.630	0.586	0.666	0.750	0.754	0.780	0.916	0.962	5	26	0.294
1.00 UNM	0.250	1.000	0.964	0.838	0.810	0.700	0.652	0.740	0.832	0.838	0.866	1.018	1.068	5	26	0.363
1.10 UNM	0.250	1.100	1.064	0.938	0.910	0.800	0.752	0.840	0.932	0.938	0.966	1.118	1.168	4	51	0.478
1.20 UNM	0.250	1.200	1.164	1.038	1.010	0.900	0.852	0.940	1.032	1.038	1.066	1.218	1.268	4	23	0.608
1.40 UNM	0.300	1.400	1.358	1.205	1.173	1.040	0.984	1.088	1.196	1.205	1.237	1.422	1.480	4	32	0.811
	Thds. per in.	inch	inch	inch	inch	inch	inch	inch	inch	inch	inch	inch	inch	deg	min	sq in
0.30 UNM	318	0.0118	0.0112	0.0098	0.0092	0.0080	0.0072	0.0085	0.0100	0.0098	0.0104	0.0120	0.0129	5	52	0.000475
0.35 UNM	282	0.0138	0.0131	0.0115	0.0109	0.0095	0.0086	0.0101	0.0117	0.0115	0.0121	0.0140	0.0149	5	37	0.0000671
0.40 UNM	254	0.0157	0.0150	0.0132	0.0126	0.0110	0.0101	0.0117	0.0134	0.0132	0.0138	0.0160	0.0170	5	26	0.0000901
0.45 UNM	254	0.0177	0.0170	0.0152	0.0145	0.0130	0.0120	0.0136	0.0154	0.0152	0.0158	0.0180	0.0190	4	44	0.0001262
0.50 UNM	203	0.0197	0.0189	0.0165	0.0158	0.0138	0.0127	0.0146	0.0166	0.0165	0.0172	0.0200	0.0212	5	26	0.0001407
0.55 UNM	203	0.0217	0.0208	0.0185	0.0177	0.0157	0.0146	0.0165	0.0186	0.0185	0.0192	0.0220	0.0231	4	51	0.0001852
0.60 UNM	169	0.0236	0.0227	0.0198	0.0190	0.0165	0.0153	0.0175	0.0198	0.0198	0.0206	0.0240	0.0254	5	26	0.000203
0.70 UNM	145	0.0276	0.0265	0.0231	0.0222	0.0193	0.0179	0.0204	0.0231	0.0231	0.0240	0.0281	0.0295	5	26	0.000276
0.80 UNM	127	0.0315	0.0303	0.0264	0.0254	0.0220	0.0205	0.0233	0.0303	0.0264	0.0273	0.0321	0.0337	5	26	0.000360
0.90 UNM	113	0.0354	0.0341	0.0297	0.0287	0.0248	0.0231	0.0262	0.0295	0.0297	0.0307	0.0361	0.0379	5	26	0.000456
1.00 UNM	102	0.0394	0.0380	0.0330	0.0319	0.0276	0.0257	0.0291	0.0327	0.0330	0.0341	0.0401	0.0420	5	26	0.000563
1.10 UNM	102	0.0433	0.0419	0.0369	0.0358	0.0315	0.0296	0.0331	0.0367	0.0369	0.0380	0.0440	0.0460	4	51	0.000741
1.20 UNM	102	0.0472	0.0458	0.0409	0.0397	0.0354	0.0335	0.0370	0.0406	0.0409	0.0420	0.0480	0.0499	4	23	0.000943
1.40 UNM	85	0.0551	0.0535	0.0474	0.0462	0.0409	0.0387	0.0428	0.0471	0.0474	0.0487	0.0560	0.0583	4	32	0.001257

^a Sizes shown in bold type are preferred.

^b This is also the basic dimension.

^c This limit, in conjunction with root form shown in Table 2, is advocated for use when optical projection methods of gaging are employed. For mechanical gaging the minimum minor diameter of the internal thread is applied.

^d This limit is provided for reference only. In practice, the form of the threading tool is relied upon for this limit.

^e This limit is provided for reference only, and is not gaged. For gaging, the maximum major diameter of the external thread is applied.

**Table 6. Unified Miniature Screw Threads—
 Minimum Root Flats for External Threads**

Pitch mm	No. of Threads Per Inch	Thread Height for Min. Flat at Root $0.64p$		Minimum Flat at Root $F_r = 0.136p$	
		mm	Inch	mm	Inch
0.080	318	0.0512	0.00202	0.0109	0.00043
0.090	282	0.0576	0.00227	0.0122	0.00048
0.100	254	0.0640	0.00252	0.0136	0.00054
0.125	203	0.0800	0.00315	0.0170	0.00067
0.150	169	0.0960	0.00378	0.0204	0.00080
0.175	145	0.1120	0.00441	0.0238	0.00094
0.200	127	0.1280	0.00504	0.0272	0.00107
0.225	113	0.1440	0.00567	0.0306	0.00120
0.250	102	0.1600	0.00630	0.0340	0.00134
0.300	85	0.1920	0.00756	0.0408	0.00161

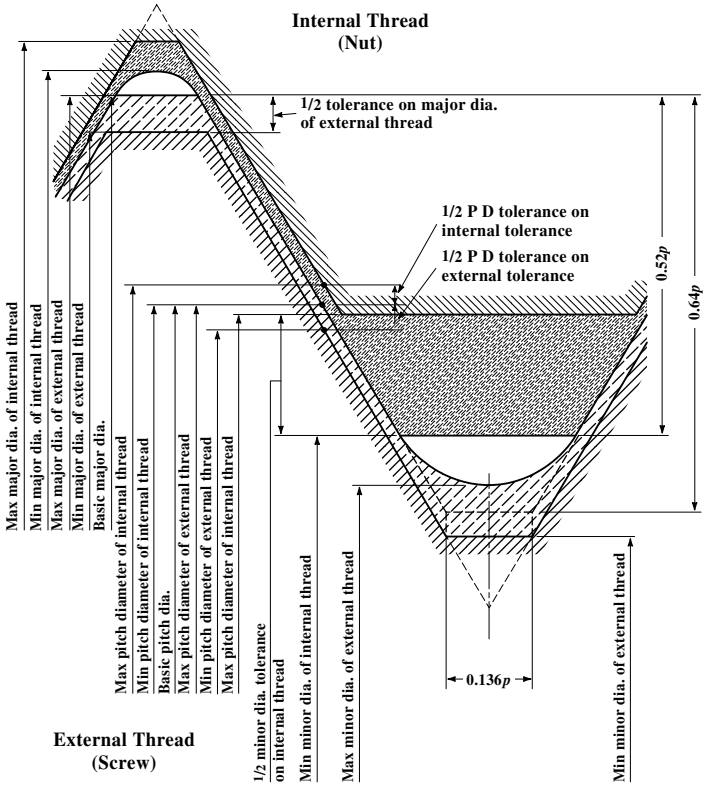

Limits of Size Showing Tolerances and Crest Clearances for UNM Threads

Limits of Size: Formulas used to determine limits of size are given in **Table 4**; the limits of size are given in **Table 5**. The diagram on page 1768 illustrates the limits of size and **Table 6** gives values for the minimum flat at the root of the external thread shown on the diagram.

Classes of Threads: The standard establishes one class of thread with zero allowance on all diameters. When coatings of a measurable thickness are required, they should be included within the maximum material limits of the threads since these limits apply to both coated and uncoated threads.

Hole Sizes for Tapping: Suggested hole sizes are given in the Tapping Section.

Unified Screw Threads of UNJ Basic Profile

British Standard UNJ Threads.—This British Standard BS 4084: 1978 arises from a request originating from within the British aircraft industry and is based upon specifications for Unified screw threads and American military standard MIL-S-8879.

These UNJ threads, having an enlarged root radius, were introduced for applications requiring high fatigue strength where working stress levels are high, in order to minimize size and weight, as in aircraft engines, airframes, missiles, space vehicles and similar designs where size and weight are critical. To meet these requirements the root radius of external Unified threads is controlled between appreciably enlarged limits, the minor diameter of the mating internal threads being appropriately increased to insure the necessary clearance. The requirement for high strength is further met by restricting the tolerances for UNJ threads to the highest classes, Classes 3A and 3B, of Unified screw threads.

The standard, not described further here, contains both a coarse and a fine pitch series of threads. BS 4084: 1978 is technically identical to ISO 3161-1977 except for Appendix A.

ASME Unified Inch Screw Threads, UNJ Form.—The ASME B1.15-1995 standard is similar to Military Specification MIL-S-8879, and equivalent to ISO 3161-1977 for thread Classes 3A and 3B.

The ASME B1.15-1995 standard establishes the basic profile for the UNJ thread form, specifies a system of designation, lists the standard series of diameter-pitch combinations for diameters from 0.060 to 6.00 inches, and specifies limiting dimensions and tolerances. It specifies the characteristics of the UNJ inch series of threads having 0.15011*P* to 0.18042*P* designated radius at the root of the external thread, and also having the minor diameter of the external and internal threads increased above the ASME B1.1 UN and UNR thread forms to accommodate the external thread maximum root radius.

UNJ threads are similar to UN threads except for a large radius in the root, or minor diameter, of the external thread. The radius eliminates sharp corners in the minor diameter of the bolt to increase the stripping strength. The fillets or radius in sharp corners increases strength at stress points where cracking or failure may occur due to change in temperature, heavy loads, or vibration. Other dimensions are the same as the UN thread.

Because the radius on the external thread increases the minor diameter of the bolt, the internal thread, or nut, is modified accordingly to permit assembly. The minor diameter of the internal thread is enlarged to clear the radius. This is the only change to the internal thread. All other dimensions are the same as standard Unified threads. Different types of tap drill sizes are required to produce UNJ thread. All tooling for external threads, thread rolls, and chasers must be made to produce a radius at the minor diameter. All runout or incomplete threads shall have a radius also.

Thread conforming to the ASME B1.1 UN profile and the UNJ profile are not interchangeable because of possible interference between the UNJ external thread minor diameter and the UN internal thread minor diameter. However, the UNJ internal thread will assemble with the UN external thread.

CALCULATING THREAD DIMENSIONS

Introduction

The purpose of the ASME B1.30 standard is to establish uniform and specific practices for calculating and rounding the numeric values used for inch and metric screw thread design data dimensions only. No attempt has been made to establish a policy of rounding actual thread characteristics measured by the manufacturer or user of thread gages. Covered is the *Standard Rounding Policy*^{*} regarding the last figure or decimal place to be retained by a numeric value and the number of decimal places to be retained by values used in intermediate calculations of thread design data dimensions. Values calculated to this ASME B1.30 Standard for inch and metric screw thread design data dimensions may vary slightly from values shown in existing issues of ASME B1 screw thread standards and are to take precedence in all new or future revisions of ASME B1 standards as applicable except as noted in following paragraph.

Metric Application.—Allowances (fundamental deviations) and tolerances for metric M and MJ screw threads are based upon formulas which appear in applicable standards. Values of allowances for standard tolerance positions and values of tolerances for standard tolerance grades are tabulated in these standards for a selection of pitches. Rounding rules specified in ASME B1.30 have not been applied to these values but have followed practices of the International Organization for Standardization (ISO). For pitches which are not included in the tables, standard formulas and the rounding rules specified herein are applicable.

ISO rounding practices, for screw thread tolerances and allowances, use rounding to the nearest values in the R40 series of numbers in accordance with ISO 3 (see page 672). In some cases, the rounded values have been adjusted to produce a smooth progression. Since the ISO rounded values have been standardized internationally, for metric screw threads, it would lead to confusion if tolerances and allowances were recalculated using B1.30 rules for use in the USA. B1.30 rounding rules are, therefore, only applicable to special threads where tabulated values do not exist in ISO standards. Values calculated using the ISO R40 series values may differ from those calculated using B1.30. In such a case the special thread values generated using B1.30 take precedence.

Purpose.—Thread dimensions calculated from published formulas frequently may not yield the exact values published in the standards. The difference in most cases are due to rounding policy.

The ASME B1.30 standard specifies that pitch, P , values shall be rounded to eight decimal places. In **Example 1** that follows on page 1772, the pitch of 28 threads per inch, 0.03571429, is correct; using $\frac{1}{28}$ or 0.0357 or 0.0357142856 instead of 0.03571429 will not produce values that conform to values calculated according this standard.

The rounding rules specified by the standard are not uniform, and vary by feature. Pitch is held to eight decimal places, maximum major diameter to four decimal places, and tolerances to six decimal places. In order to maintain same screw dimensions, everybody has to follow the same rounding practice.

Basic profile of UN and UNF screw threads are shown on **Fig. 1**. Here we show two example of detail calculations of UNEF and UNS External and Internal thread, where all the ins and outs of rounding policy, formulas, and detail description is provided for better understanding, and individual to find out accurate dimensions.

^{*} It is recognized that ASME B1.30 is not in agreement with other published documents, e.g., ASME SI-9, *Guide for Metrication of Codes and Standards SI (Metric) Units*, and IEEE/ASTM SI 10, *Standard for Metric Practice*. The rounding practices used in the forenamed documents are designed to produce even distribution of numerical values. The purpose of this document is to define the most practical and common used method of rounding numerical thread form values. Application of this method is far more practical in the rounding of thread form values.

Calculating and Rounding Dimensions

Rounding of Decimal Values.—The following rounding practice represents the method to be used in new or future revisions of ASME B1 thread standards.

Rounding Policy: When the figure next beyond the last figure or place retained is less than 5, the figure in the last place retained is kept unchanged.

Example:

1.012342	1.01234
1.012342	1.0123
1.012342	1.012

When the figure next beyond the last figure or place retained is greater than 5, the figure in the last place retained is increased by 1.

Example:

1.56789	1.5679
1.56789	1.568
1.56789	1.57

When the figure next beyond the last figure or place retained is 5, and:

- 1) There are no figures, or only zeros, beyond the 5, the last figure should be increased by 1.

Example:

1.01235	1.0124
1.0123500	1.0124
1.012345	1.01235
1.01234500	1.01235

- 2) If the 5 next beyond the figure in the last place to be retained is followed by any figures other than zero, the figure in the last place retained should be increased by 1.

Example:

1.0123501	1.0124
1.0123599	1.0124
1.01234501	1.01235
1.01234599	1.01235

The final rounded value is obtained from the most precise value available and not from a series of successive rounding. For example, 0.5499 should be rounded to 0.550, 0.55 and 0.5 (not 0.6), since the most precise value available is less than 0.55. Similarly, 0.5501 should be rounded as 0.550, 0.55 and 0.6, since the most precise value available is more than 0.55. In the case of 0.5500 rounding should be 0.550, 0.55 and 0.6, since the most precise value available is 0.5500.

Calculations from Formulas, General Rules.—1) Values for pitch and constants derived from a function of pitch are used out to eight decimal places for inch series. The eight place values are obtained by rounding their truncated ten place values.

Seven decimal place values for metric series constants are derived by rounding their truncated nine place values.

Values used in intermediate calculations are rounded to two places beyond the number of decimal places retained for the final value, see [Tables 1 and 7](#).

- 2) Rounding to the final value is the last step in a calculation.

Example 1, Rounding Inch Series:

$$n = 28 \text{ threads per inch} \quad P = \frac{1}{n} = \frac{1}{28}$$

$$P = 0.0357142857 \quad (\text{calculated and truncated to 10 places})$$

$$P = 0.03571429 \quad (\text{rounded to 8 places})$$

Table 1. Number of Decimal Places Used in Calculations

Units	Pitch	Constants	Intermediate	Final
Inch	8	8	6	4
Metric	as designated	7	5	3

3) For inch screw thread dimensions, four decimal places are required for the final values of pitch diameter, major diameter, and minor diameter with the exception of Class 1B and 2B internal thread minor diameters for thread sizes 0.138 and larger.

The final values for the allowances and tolerances applied to thread elements are expressed to four decimal places except for external thread pitch diameter tolerance, Td_2 , which is expressed to six decimal places.

Minor Diameter Exceptions for Internal Threads:

Minimum Minor Diameter: All classes are calculated and then rounded off to the nearest 0.001 inch and expressed in three decimal places for sizes 0.138 inch and larger. For Class 3B, a zero is added to yield four decimal places.

Maximum Minor Diameter: All classes are calculated before rounding, then rounded for Classes 1B and 2B to the nearest 0.001 in. for sizes 0.138 in. and larger. Class 3B values are rounded to four decimal places.

4) Metric screw threads are dimensioned in millimeters. The final values of pitch diameter, major diameter, minor diameter, allowance and thread element tolerances are expressed to three decimal places.

5) Values containing multiple trailing zeros out to the required number of decimal places can be expressed by displaying only two of them beyond the last significant digit.

Example: 20 threads per inch has a pitch equal to 0.05000000 and can be expressed as 0.0500.

Examples

Inch Screw Threads.—The formulas in the examples for inch screw threads are based on those listed in ASME B1.1, *Unified Inch Screw Threads*. Table 3 and Table 4 are based on a size that when converted from a fraction to a decimal will result in a number that has only four decimal places. Table 5 and Table 6 are based on a size that when converted will result in a number with infinite numbers of digits after the decimal point. Fig. 1 is provided for reference.

Metric Screw Threads.—The formulas for metric screw threads are based on those listed in ASME B1.13M, *Metric Screw Threads*. The calculation of size limits for standard diameter/pitch combinations listed in both ISO 261 and ASME B1.13M use of the tabulated values for allowances and tolerances (in accordance with ISO 965-1). The constant values differ from those used for inch screw threads, in accordance with the policy of rounding of this standard, because metric limits of size are expressed to only three decimal places rather than four.

Thread Form Constants.—For thread form data see Table 2. The number of decimal places and the manner in which they are listed should be consistent. Thread form constants printed in older thread standards are based on a function of thread height (H) or pitch (P). The equivalent of the corresponding function is also listed. There are some constants that would require these values to 8 or 7 decimal places before they would round to equivalent

values. For standardization the tabulated listing of thread values based on a function of pitch has been established, with thread height used as a reference only. All thread calculations are to be performed using a function of pitch (P), rounded to 8 decimal places for inch series and as designated for metric series, not a function of thread height (H). Thread height is to be used for reference only. See Table 7.

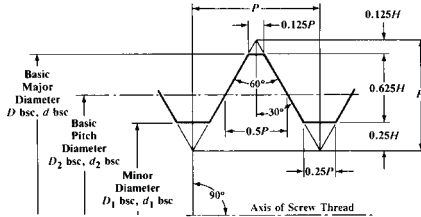

Fig. 1. Basic Profile of UN and UNF Screw Threads

Table 2. Thread Form Data

Constant for Inch Series (8-place)	Reference Values		Constant for Metric Series (7-place)
$0.04811252P$	$\frac{1}{18}H$	$0.0556H$	$0.0481125P$
$0.05412659P$	$\frac{1}{16}H$	$0.0625H$	$0.0541266P$
$0.08660254P$	$\frac{1}{10}H$	$0.1000H$	$0.0866025P$
$0.09622504P$	$\frac{1}{9}H$	$0.1111H$	$0.0962250P$
$0.10825318P$	$\frac{1}{8}H$	$0.1250H$	$0.1082532P$
$0.12990381P$	$\frac{3}{20}H$	$0.1500H$	$0.1299038P$
$0.14433757P$	$\frac{1}{6}H$	$0.1667H$	$0.1443376P$
$0.16237976P$	$\frac{3}{16}H$	$0.1875H$	$0.1623798P$
$0.21650635P$	$\frac{1}{4}H$	$0.2500H$	$0.2165064P$
$0.28867513P$	$\frac{1}{3}H$	$0.3333H$	$0.2886751P$
$0.32475953P$	$\frac{3}{8}H$	$0.3750H$	$0.3247595P$
$0.36084392P$	$\frac{5}{12}H$	$0.4167H$	$0.3608439P$
$0.39692831P$	$\frac{1}{24}H$	$0.4583H$	$0.3969283P$
$0.43301270P$	$\frac{1}{2}H$	$0.5000H$	$0.4330127P$
$0.48713929P$	$\frac{9}{16}H$	$0.5625H$	$0.4871393P$
$0.54126588P$	$\frac{5}{8}H$	$0.6250H$	$0.5412659P$
$0.57735027P$	$\frac{2}{3}H$	$0.6667H$	$0.5773503P$
$0.59539246P$	$\frac{1}{16}H$	$0.6875H$	$0.5953925P$
$0.61343466P$	$\frac{1}{24}H$	$0.7083H$	$0.6134347P$
$0.61602540P$...	$0.7113H$	$0.6160254P$
$0.64951905P$	$\frac{3}{4}H$	$0.7500H$	$0.6495191P$
$0.72168783P$	$\frac{5}{6}H$	$0.8333H$	$0.7216878P$
$0.79385662P$	$\frac{1}{12}H$	$0.9167H$	$0.7938566P$
$0.86602540P$	H	$1.0000H$	$0.8660254P$
$1.08253175P$	$\frac{3}{4}H$	$1.2500H$	$1.0825318P$
$1.19078493P$	$\frac{1}{8}H$	$1.3750H$	$1.1907849P$
$1.22686932P$	$\frac{1}{12}H$	$1.4167H$	$1.2268693P$

Table 3. External Inch Screw Thread Calculations for 1/2-28 UNEF-2A

Characteristic Description	Calculation	Notes
Basic major diameter, d_{bsc}	$d_{bsc} = \frac{1}{2} = 0.5 = 0.5000$	d_{bsc} is rounded to four decimal places
Pitch, P	$P = \frac{1}{28} = 0.035714285714 = 0.03571429$	P is rounded to eight decimal places
Maximum external major diameter (d_{max}) = basic major diameter (d_{bsc}) – allowance (es)	$d_{max} = d_{bsc} - es$	es is the basic allowance
Basic major diameter (d_{bsc})	$d_{bsc} = 0.5000$	d_{bsc} is rounded to four decimal places
Allowance (es)	$es = 0.300 \times Td_2$ for Class 2A	Td_2 is the pitch diameter tolerance for Class 2A
External pitch diameter tolerance Td_2	$Td_2 = 0.0015D^{\frac{1}{3}} + 0.0015\sqrt{LE} + 0.015P^{\frac{2}{3}}$ $= 0.0015 \times 0.5^{\frac{1}{3}} + 0.0015\sqrt{9 \times 0.03571429} + 0.015(0.03571429)^{\frac{2}{3}}$ $= 0.001191 + 0.000850 + 0.001627 = 0.003668$	$LE = 9P$ (length of engagement) Td_2 is rounded to six decimal places
Allowance (es)	$es = 0.300 \times 0.003668 = 0.0011004 = 0.0011$	es is rounded to four decimal places
Maximum external major diameter (d_{max})	$d_{max} = d_{base} - es = 0.5000 - 0.0011 = 0.4989$	d_{max} is rounded to four decimal places
Minimum external major diameter (d_{min}) = maximum external major diameter (d_{max}) – major diameter tolerance (Td)	$d_{min} = d_{max} - Td$	Td is the major diameter tolerance
Major diameter tolerance (Td)	$Td = 0.060\sqrt[3]{P^2} = 0.060 \times \sqrt[3]{0.03571429^2}$ $= 0.060 \times \sqrt[3]{0.001276} = 0.060 \times 0.108463$ $= 0.00650778 = 0.0065$	Td is rounded to four decimal places

Table 3. (Continued) External Inch Screw Thread Calculations for 1/2-28 UNEF-2A

Characteristic Description	Calculation	Notes
Minimum external major diameter (d_{min})	$d_{min} = d_{max} - Td = 0.4989 - 0.006508$ $= 0.492392 = 0.4924$	d_{min} is rounded to four decimal places
Maximum external pitch diameter (d_{2max}) = maximum external major diameter (d_{max}) - twice the external thread addendum (h_{as})	$d_{2max} = d_{max} - 2 \times h_{as}$	h_{as} = external thread addendum
External thread addendum	$h_{as} = \frac{0.64951905P}{2}$ $2h_{as} = 0.64951905P$ $2h_{as} = 0.64951905 \times 0.03571429 = 0.02319711$ $= 0.023197$	$2h_{as}$ is rounded to six decimal places
Maximum external pitch diameter (d_{2max})	$d_{2max} = d_{max} - 2 \times h_{as} = 0.4989 - 0.23197$ $= 0.475703 = 0.4757$	d_{2max} is rounded to four decimal places
Minimum external pitch diameter (d_{2min}) = maximum external pitch diameter (d_{2max}) - external pitch diameter tolerance (Td_2)	$d_{2min} = d_{2max} - Td_2$	Td_2 = external pitch diameter tolerance (see previous Td_2 calculation in this table)
Minimum external pitch diameter (d_{2min})	$d_{2min} = d_{2max} - Td_2 = 0.4757 - 0.003668$ $= 0.472032 = 0.4720$	d_{2min} is rounded to four decimal places
Maximum external UNR minor diameter (d_{3max}) = maximum external major diameter (d_{max}) - double height of external UNR thread $2h_s$	$d_{3max} = d_{max} - 2 \times h_s$	h_s = external UNR thread height,
External UNR thread height ($2h_s$)	$2h_s = 1.19078493P = 1.19078493 \times 0.03571429$ $= 0.042528$	$2h_s$ rounded to six decimal places
Maximum external UNR minor diameter (d_{3max})	$d_{3max} = d_{max} - 2 \times h_s = 0.4989 - 0.042528$ $= 0.456372 = 0.4564$	d_{3max} is rounded to four decimal places

Table 3. (Continued) External Inch Screw Thread Calculations for 1/2-28 UNEF-2A

Characteristic Description	Calculation	Notes
Maximum external UN minor diameter (d_{1max}) = maximum external major diameter (d_{max}) – double height of external UN thread $2h_s$	$d_{1max} = d_{max} - 2 \times h_s$	For UN threads, $2h_s = 2h_n$
Double height of external UN thread $2h_s$	$2h_s = 1.08253175P$ $= 1.08253175 \times 0.03571429 = 0.03866185$ $= 0.038662$	$2h_s$ is rounded to six decimal places
Maximum external UN minor diameter (d_{1max})	$d_{1max} = d_{max} - 2 \times h_s$ $= 0.4989 - 0.038662 = 0.460238 = 0.4602$	d_{1max} is rounded to four decimal places

Table 4. Internal Inch Screw Thread Calculations for 1/2-28 UNEF-2B

Characteristic Description	Calculation	Notes
Basic major diameter, d_{bsc}	$d_{bsc} = \frac{1}{2} = 0.5 = 0.5000$	d_{bsc} is rounded to four decimal places
Pitch, P	$P = \frac{1}{28} = 0.035714285714 = 0.03571429$	P is rounded to eight decimal places
Minimum internal minor diameter (D_{1min}) = basic major diameter (D_{bsc}) – double height of external UN thread $2h_n$	$D_{1min} = D_{bsc} - 2h_n$	$2h_n$ is the double height of external UN thread
Double height of external UN thread $2h_s$	$2h_n = 1.08253175P = 1.08253175 \times 0.03571429$ $= 0.03866185 = 0.038662$	$2h_n$ is rounded to six decimal places
Minimum internal major diameter (D_{1min})	$D_{1min} = D_{bsc} - 2 \times h_n = 0.5000 - 0.038662$ $= 0.461338 = 0.461$	For class 2B the value is rounded to three decimal places to obtain the final values

Table 4. (Continued) Internal Inch Screw Thread Calculations for 1/2-28 UNEF-2B

Characteristic Description	Calculation	Notes
Maximum internal minor diameter (D_{1max}) = minimum internal minor diameter (D_{1min}) + internal minor diameter tolerance TD_1	$D_{1max} = D_{1min} + TD_1$	D_{1min} is rounded to six decimal places
Internal minor diameter tolerance TD_1	$TD_1 = 0.25P - 0.40P^2$ $= 0.25 \times 0.03571429 - 0.40 \times 0.03571429^2$ $= 0.008929 - 0.000510 = 0.008419 = 0.003127$	TD_1 is rounded to four decimal places.
Maximum internal minor diameter (D_{1max})	$D_{1max} = D_{1min} + TD_1 = 0.461338 + 0.008419$ $= 0.469757 = 0.470$	For the Class 2B thread D_{1max} is rounded to three decimal places to obtain final values. Other sizes and classes are expressed in a four decimal places
Minimum internal pitch diameter (D_{2min}) = basic major diameter (D_{bsc}) – twice the external thread addendum (h_b)	$D_{2min} = D_{bsc} - h_b$	h_b = external thread addendum
External thread addendum (h_b)	$h_b = 0.64951905P = 0.64951905 \times 0.03571429$ $= 0.02319711 = 0.023197$	h_b is rounded to six decimal places
Minimum internal pitch diameter (D_{2min})	$D_{2min} = D_{bsc} - h_b = 0.5000 - 0.023197$ $= 0.476803 = 0.4768$	D_{2min} is rounded to four decimal places
Maximum internal pitch diameter (D_{2max}) = minimum internal pitch diameter (D_{2min}) + internal pitch diameter tolerance (TD_2)	$D_{2max} = D_{2min} + TD_2$	TD_2 = external pitch diameter tolerance
External pitch diameter tolerance TD_2	$TD_2 = 1.30 \times (Td_2 \text{ for Class 2A}) = 1.30 \times 0.003668$ $= 0.0047684 = 0.0048$	Constant 1.30 is for this Class 2B example, and will be different for Classes 1B and 3B. Td_2 for Class 2A (see Table 3) is rounded to six decimal places. TD_2 is rounded 4 to places
Maximum internal pitch diameter (D_{2max})	$D_{2max} = D_{2min} + TD_2 = 0.4768 + 0.0048 = 0.4816$	D_{2max} is rounded to four decimal places

Table 4. (Continued) Internal Inch Screw Thread Calculations for 1/2-28 UNEF-2B

Characteristic Description	Calculation	Notes
Minimum internal major diameter (D_{min}) = basic major diameter (D_{bsc})	$D_{min} = D_{bsc} = 0.5000$	D_{min} is rounded to four decimal places

Table 5. External Inch Screw Thread Calculations for 19/64-36 UNS-2A

Characteristic Description	Calculation	Notes
Basic major diameter, d_{bsc}	$d_{bsc} = \frac{19}{64} = 0.296875 = 0.2969$	d_{bsc} is rounded to four decimal places
Pitch, P	$P = \frac{1}{36} = 0.02777777777778 = 0.02777778$	P is rounded to eight decimal places
Maximum external major diameter (d_{max}) = basic major diameter (d_{bsc}) – allowance (es)	$d_{max} = d_{bsc} - es$	
Allowance (es)	$es = 0.300 \times Td_2$ for Class 2A	Td_2 is Pitch diameter tolerance for Class 2A
External pitch diameter tolerance, Td_2	$Td_2 = 0.0015D^{\frac{1}{3}} + 0.0015\sqrt{LE} + 0.015P^{\frac{2}{3}}$ $= 0.0015 \times 0.2969^{\frac{1}{3}} + 0.0015\sqrt{9 \times 0.02777778} + 0.015(0.02777778)^{\frac{2}{3}}$ $= 0.001000679 + 0.00075 + 0.001375803 = 0.003126482$ $= 0.003127$	$LE = 9P$ (length of engagement) Td_2 is rounded to six decimal places
Allowance (es)	$es = 0.300 \times 0.003127 = 0.0009381 = 0.0009$	es is rounded to four decimal places
Maximum external major diameter (d_{max})	$d_{max} = d_{bsc} - es = 0.2969 - 0.0009 = 0.2960$	d_{max} is rounded to four decimal places

Table 5. (Continued) External Inch Screw Thread Calculations for $\frac{19}{64}$ -36 UNS-2A

Characteristic Description	Calculation	Notes
Minimum external major diameter (d_{min}) = maximum external major diameter (d_{max}) – major diameter tolerance (Td)	$d_{min} = d_{max} - Td$	Td is the major diameter tolerance
Major diameter tolerance (Td)	$Td = 0.060 \sqrt[3]{P^2} = 0.060 \times \sqrt[3]{0.02777778^2}$ $= 0.060 \times \sqrt[3]{0.000772} = 0.060 \times 0.091736$ $= 0.00550416 = 0.0055$	Td is rounded to four decimal places
Minimum external major diameter (d_{min})	$d_{min} = d_{max} - Td = 0.2960 - 0.0055 = 0.2905$	d_{min} is rounded to four decimal places
Maximum external pitch diameter (d_{2max}) = maximum external major diameter (d_{max}) – twice the external thread addendum	$d_{2max} = d_{max} - 2 \times h_{as}$	h_{as} = external thread addendum
External thread addendum	$h_{as} = \frac{0.64951905P}{2} \quad 2h_{as} = 0.64951905P$ $2h_{as} = 0.64951905 \times 0.02777778 = 0.0180421972$ $= 0.018042$	h_{as} is rounded to six decimal places
Maximum external pitch diameter (d_{2max})	$d_{2max} = d_{max} - 2h_{as} = 0.2960 - 0.018042$ $= 0.277958 = 0.2780$	d_{2max} is rounded to four decimal places
Minimum external pitch diameter (d_{2min}) = maximum external pitch diameter (d_{2max}) – external pitch diameter tolerance (Td_2)	$d_{2min} = d_{2max} - Td_2$	Td_2 = external pitch diameter tolerance (see previous Td_2 calculation in this table)
Minimum external pitch diameter (d_{2min})	$d_{2min} = d_{2max} - Td_2 = 0.2780 - 0.003127$ $= 0.274873 = 0.2749$	d_{2min} is rounded to four decimal places

Table 5. (Continued) External Inch Screw Thread Calculations for $\frac{19}{64}$ -36 UNS-2A

Characteristic Description	Calculation	Notes
Maximum external UNR minor diameter (d_{3max}) = maximum external major diameter (d_{max}) – double height of external UNR thread $2h_s$	$d_{3max} = d_{max} - 2h_s$	h_s = external UNR thread height,
External UNR thread height	$2h_s = 1.19078493P = 1.19078493 \times 0.02777778$ $= 0.033077362 = 0.033077$	$2h_s$ is rounded to six decimal places
Maximum external UNR minor diameter (d_{3max})	$d_{3max} = d_{max} - 2h_s = 0.2960 - 0.033077$ $= 0.262923 = 0.2629$	d_{3max} is rounded to four decimal places
Maximum external UN minor diameter (d_{1max}) = maximum external major diameter (d_{max}) – double height of external UN thread $2h_s$	$d_{1max} = d_{max} - 2 \times h_s$	For UN threads, $2h_s = 2h_n$
Double height of external UN thread $2h_s$	$2h_s = 1.08253175P = 1.08253175 \times 0.02777778$ $= 0.030070329 = 0.030070$	For UN threads, $2h_s = 2h_n$ $2h_s$ is rounded to six decimal places
Maximum external UN minor diameter (d_{1max})	$d_{1max} = d_{max} - 2h_s = 0.2960 - 0.030070$ $= 0.265930 = 0.2659$	Maximum external UN minor diameter is rounded to four decimal places

Table 6. Internal Inch Screw Thread Calculations for $\frac{19}{64}$ -28 UNS-2B

Characteristic Description	Calculation	Notes
Minimum internal minor diameter (D_{1min}) = basic major diameter (D_{bsc}) – double height of external UN thread $2h_n$	$D_{1min} = D_{bsc} - 2h_n$	$2h_n$ is the double height of external UN threads
Basic major diameter (D_{bsc})	$D_{bsc} = \frac{19}{64} = 0.296875 = 0.2969$	This is the final value of basic major diameter (given) and rounded to four decimal places

Table 6. (Continued) Internal Inch Screw Thread Calculations for $\frac{19}{64}$ -28 UNS-2B

Characteristic Description	Calculation	Notes
Double height of external UN thread $2h_n$	$2h_n = 1.08253175P = 1.08253175 \times 0.02777778$ $= 0.030070329 = 0.030070$	P is rounded to eight decimal places
Minimum internal major diameter (D_{1min})	$D_{1min} = D_{bsc} - 2h_n = 0.2969 - 0.030070$ $= 0.266830 = 0.267$	For class 2B the value is rounded to three decimal places to obtain the final value, other sizes and classes are expressed in a four place decimal.
Maximum internal minor diameter (D_{1max}) = minimum internal minor diameter (D_{1min}) + internal minor diameter tolerance TD_1	$D_{1max} = D_{1min} + TD_1$	D_{1min} is rounded to six decimal places
Internal minor diameter tolerance TD_1	$TD_1 = 0.25P - 0.40P^2$ $= 0.25 \times 0.02777778 - 0.40 \times 0.02777778^2$ $= 0.006944 - 0.000309 = 0.006635 = 0.0066$	TD_1 is rounded to four decimal places.
Maximum internal minor diameter (D_{1max})	$D_{1max} = D_{1min} + TD_1 = 0.266830 + 0.006635$ $= 0.273465 = 0.273$	For Class 2B thread the value is rounded to three decimal places to obtain the final values. Other sizes and classes are expressed in a four decimal places
Minimum internal pitch diameter (D_{2min}) = basic major diameter (D_{bsc}) – twice the external thread addendum (h_b)	$D_{2min} = D_{1max} - h_b$	h_b = external thread addendum
External thread addendum	$h_b = 0.64951905P = 0.64951905 \times 0.02777778$ $= 0.018042197 = 0.018042$	h_b is rounded to six decimal places
Minimum internal pitch diameter (D_{2min})	$D_{2min} = D_{bsc} - h_b = 0.2969 - 0.018042$ $= 0.278858 = 0.2789$	D_{2min} is rounded to four decimal places

Table 6. (Continued) Internal Inch Screw Thread Calculations for $\frac{19}{64}$ -28 UNS-2B

Characteristic Description	Calculation	Notes
Maximum internal pitch diameter (D_{2max}) = minimum internal pitch diameter (D_{2min}) + internal pitch diameter tolerance (TD_2)	$D_{2max} = D_{2min} + TD_2$	TD_2 = external pitch diameter tolerance
External pitch diameter tolerance TD_2	$TD_2 = 1.30 \times (Td_2 \text{ for Class 2A})$ $= 1.30 \times 0.003127 = 0.0040651 = 0.0041$	The constant 1.30 is for this Class 2B example, and will be different for Classes 1B and 3B. Td_2 for Class 2A (see calculation, Table 5) is rounded to six decimal places
Maximum internal pitch diameter (D_{2max})	$D_{2max} = D_{2min} + TD_2 = 0.2789 + 0.0041 = 0.2830$	D_{2max} is rounded to four decimal places
Minimum internal major diameter (D_{min}) = basic major diameter (D_{bsc})	$D_{min} = D_{bsc} = 0.2969$	D_{min} is rounded to four decimal places

Table 7. Number of Decimal Places for Intermediate and Final Calculations of Thread Characteristics

Symbol	Dimensions	Intermediate		Final		Symbol	Dimensions	Intermediate		Final	
		Inch	Metric	Inch	Metric			Inch	Metric	Inch	Metric
d	Major diameter, external thread	4	3	LE	Length of thread engagement	6	N/A
D	Major diameter, internal thread	4	3	P	Pitch	8	Note ^a
d_2	Pitch diameter, external thread	4	3	Td	Major diameter tolerance	4	3
D_2	Pitch diameter, internal thread	4	3	Td_2	Pitch diameter tolerance, external thread	6	3
d_1	Minor diameter, external thread	4	3	TD_2	Pitch diameter tolerance, internal thread	4	3
d_3	Minor diameter, rounded root external thread	4	3	TD_1	Minor diameter tolerance, internal thread	4	3
D_1	Minor diameter, internal threads for sizes 0.138 and larger for Classes 1B and 2B only	3	N/A	$h_b = 2h_{as}$	Twice the external thread addendum	6	N/A
D_1	Minor diameter, internal threads for sizes smaller than 0.138 for Classes 1B and 2B, and all sizes for Class 3B	4	N/A	$2h_s$	Double height of UNR external thread	6	N/A
D_1	Minor diameter, internal metric thread	N/A	3	$2h_n$	Double height of internal thread and UN external thread	6	N/A
es	Allowance at major pitch and minor diameters of external thread		3		Twice the external thread addendum	6	N/A

^a Metric pitches are not calculated. They are stated in the screw thread designation and are to be used out to the number of decimal places as stated.

Note: Constants based on a function of P are rounded to an 8-place decimal for inch threads and a 7-place decimal for metric threads.

METRIC SCREW THREADS

American National Standard Metric Screw Threads M Profile

American National Standard ANSI/ASME B1.13M-2005 describes a system of metric threads for general fastening purposes in mechanisms and structures. The standard is in basic agreement with ISO screw standards and resolutions, as of the date of publication, and features detailed information for diameter-pitch combinations selected as to preferred standard sizes. This Standard contains general metric standards for a 60-degree symmetrical screw thread with a basic ISO 68 designated profile.

Application Comparison with Inch Threads.—The metric M profile threads of tolerance class 6H/6g (see page 1790) are intended for metric applications where the inch class 2A/2B have been used. At the minimum material limits, the 6H/6g results in a looser fit than the 2A/2B. Tabular data are also provided for a tighter tolerance fit external thread of class 4g6g which is approximately equivalent to the inch class 3A but with an allowance applied. It may be noted that a 4H5H/4h6h fit is approximately equivalent to class 3A/3B fit in the inch system.

Interchangeability with Other System Threads.—Threads produced to this Standard ANSI/ASME B1.13M are fully interchangeable with threads conforming to other National Standards that are based on ISO 68 basic profile and ISO 965/1 tolerance practices.

Threads produced to this Standard should be mechanically interchangeable with those produced to ANSI B1.18M-1982 (R1987) "Metric Screw Threads for Commercial Mechanical Fasteners—Boundary Profile Defined," of the same size and tolerance class. However, there is a possibility that some parts may be accepted by conventional gages used for threads made to ANSI/ASME B1.13M and rejected by the Double-NOT-GO gages required for threads made to ANSI B1.18M.

Threads produced in accordance with M profile and MJ profile ANSI/ASME B1.21M design data will assemble with each other. However, external MJ threads will encounter interference on the root radii with internal M thread crests when both threads are at maximum material condition.

Definitions.—The following definitions apply to metric screw threads — M profile.

Allowance: The minimum nominal clearance between a prescribed dimension and its basic dimension. Allowance is not an ISO metric screw thread term but it is numerically equal to the absolute value of the ISO term *fundamental deviation*.

Basic Thread Profile: The cyclical outline in an axial plane of the permanently established boundary between the provinces of the external and internal threads. All deviations are with respect to this boundary. (See Figs. 1 and 5.)

Bolt Thread (External Thread): The term used in ISO metric thread standards to describe all external threads. All symbols associated with external threads are designated with lower case letters. This Standard uses the term external threads in accordance with United States practice.

Clearance: The difference between the size of the internal thread and the size of the external thread when the latter is smaller.

Crest Diameter: The major diameter of an external thread and the minor diameter of an internal thread.

Design Profiles: The maximum material profiles permitted for external and internal threads for a specified tolerance class. (See Figs. 2 and 3.)

Deviation: An ISO term for the algebraic difference between a given size (actual, measured, maximum, minimum, etc.) and the corresponding basic size. The term deviation does not necessarily indicate an error.

Fit: The relationship existing between two corresponding external and internal threads with respect to the amount of clearance or interference which is present when they are assembled.

Fundamental Deviation: For Standard threads, the deviation (upper or lower) closer to the basic size. It is the upper deviation, *es*, for an external thread and the lower deviation, *EI*, for an internal thread. (See Fig. 5.)

Limiting Profiles: The limiting M profile for internal threads is shown in Fig. 6. The limiting M profile for external threads is shown in Fig. 7.

Lower Deviation: The algebraic difference between the minimum limit of size and the corresponding basic size.

Nut Thread (Internal Thread): A term used in ISO metric thread standards to describe all internal threads. All symbols associated with internal threads are designated with upper case letters. This Standard uses the term *internal thread* in accordance with United States practice.

Tolerance: The total amount of variation permitted for the size of a dimension. It is the difference between the maximum limit of size and the minimum limit of size (i.e., the algebraic difference between the upper deviation and the lower deviation). The tolerance is an absolute value without sign. Tolerance for threads is applied to the design size in the direction of the minimum material. On external threads the tolerance is applied negatively. On internal threads the tolerance is applied positively.

Tolerance Class: The combination of a tolerance position with a tolerance grade. It specifies the allowance (fundamental deviation) and tolerance for the pitch and major diameters of external threads and pitch and minor diameters of internal threads.

Tolerance Grade: A numerical symbol that designates the tolerances of crest diameters and pitch diameters applied to the design profiles.

Tolerance Position: A letter symbol that designates the position of the tolerance zone in relation to the basic size. This position provides the allowance (fundamental deviation).

Upper Deviation: The algebraic difference between the maximum limit of size and the corresponding basic size.

Basic M Profile.—The basic M thread profile also known as ISO 68 basic profile for metric screw threads is shown in Fig. 1 with associated dimensions listed in Table 3.

Design M Profile for Internal Thread.—The design M profile for the internal thread at maximum material condition is the basic ISO 68 profile. It is shown in Fig. 2 with associated thread data listed in Table 3.

Design M Profile for External Thread.—The design M profile for the external thread at the no allowance maximum material condition is the basic ISO 68 profile except where a rounded root is required. For the standard $0.125P$ minimum radius, the ISO 68 profile is modified at the root with a $0.17783H$ truncation blending into two arcs with radii of $0.125P$ tangent to the thread flanks as shown in Fig. 3 with associated thread data in Table 3.

M Crest and Root Form.—The form of crest at the major diameter of the external thread is flat, permitting corner rounding. The external thread is truncated $0.125H$ from a sharp crest. The form of the crest at the minor diameter of the internal thread is flat. It is truncated $0.25H$ from a sharp crest.

The crest and root tolerance zones at the major and minor diameters will permit rounded crest and root forms in both external and internal threads.

The root profile of the external thread must lie within the “section lined” tolerance zone shown in Fig. 4. For the rounded root thread, the root profile must lie within the “section lined” rounded root tolerance zone shown in Fig. 4. The profile must be a continuous, smoothly blended non-reversing curve, no part of which has a radius of less than $0.125P$, and which is tangential to the thread flank. The profile may comprise tangent flank arcs that are joined by a tangential flat at the root.

The root profile of the internal thread must not be smaller than the basic profile. The maximum major diameter must not be sharp.

General Symbols.—The general symbols used to describe the metric screw thread forms are shown in **Table 1**.

Table 1. American National Standard Symbols for Metric Threads
ANSI/ASME B1.13M-2005

Symbol	Explanation
<i>D</i>	Major Diameter Internal Thread
<i>D</i> ₁	Minor Diameter Internal Thread
<i>D</i> ₂	Pitch Diameter Internal Thread
<i>d</i>	Major Diameter External Thread
<i>d</i> ₁	Minor Diameter External Thread
<i>d</i> ₂	Pitch Diameter External Thread
<i>d</i> ₃	Rounded Form Minor Diameter External Thread
<i>P</i>	Pitch
<i>r</i>	External Thread Root Radius
<i>T</i>	Tolerance
<i>T</i> _{D1} , <i>T</i> _{D2}	Tolerances for <i>D</i> ₁ , <i>D</i> ₂
<i>T</i> _d , <i>T</i> _{d2}	Tolerances for <i>d</i> , <i>d</i> ₂
<i>ES</i>	Upper Deviation, Internal Thread [Equals the Allowance (Fundamental Deviation) Plus the Tolerance]. See Fig. 5 .
<i>EI</i>	Lower Deviation, Internal Thread Allowance (Fundamental Deviation). See Fig. 5 .
<i>G, H</i>	Letter Designations for Tolerance Positions for Lower Deviation, Internal Thread
<i>g, h</i>	Letter Designations for Tolerance Positions for Upper Deviation, External Thread
<i>es</i>	Upper Deviation, External Thread Allowance (Fundamental Deviation). See Fig. 5 . In the ISO system <i>es</i> is always negative for an allowance fit or zero for no allowance.
<i>ei</i>	Lower Deviation, External Thread [Equals the Allowance (Fundamental Deviation) Plus the Tolerance]. See Fig. 5 . In the ISO system <i>ei</i> is always negative for an allowance fit.
<i>H</i>	Height of Fundamental Triangle
<i>LE</i>	Length of Engagement
<i>LH</i>	Left Hand Thread

Standard M Profile Screw Thread Series.—The standard metric screw thread series for general purpose equipment's threaded components design and mechanical fasteners is a *coarse thread* series. Their diameter/pitch combinations are shown in **Table 4**. These diameter/pitch combinations are the preferred sizes and should be the first choice as applicable. Additional *fine pitch* diameter/pitch combinations are shown in **Table 5**.

Table 2. American National Standard General Purpose and Mechanical Fastener Coarse Pitch Metric Thread—M Profile Series ANSI/ASME B1.13M-2005

Nom.Size	Pitch	Nom.Size	Pitch	Nom.Size	Pitch	Nom.Size	Pitch
1.6	0.35	6	1	22	2.5 ^a	56	5.5
2	0.4	8	1.25	24	3	64	6
2.5	0.45	10	1.5	27	3 ^a	72	6 ^b
3	0.5	12	1.75	30	3.5	80	6 ^b
3.5	0.6	14	2	36	4	90	6 ^b
4	0.7	16	2	42	4.5	100	6 ^b
5	0.8	20	2.5	48	5

^aFor high strength structural steel fasteners only.

^bDesignated as part of 6 mm fine pitch series in ISO 261.

All dimensions are in millimeters.

Table 3. American National Standard Metric Thread — M Profile Data ANSI/ASME B1.13M-2005

Pitch <i>P</i>	Truncation of Internal Thread Root and External Thread Crest	Addendum of Internal Thread and Truncation of Internal Thread	Dedendum of Internal Thread and Addendum External Thread	Difference ^a	Height of Internal Thread and Depth of Thread Engagement	Difference ^b	Twice the External Thread Addendum	Difference ^c	Height of Sharp V-Thread	Double Height of Internal Thread
	$\frac{H}{8}$ 0.1082532 <i>P</i>	$\frac{H}{4}$ 0.2165064 <i>P</i>	$\frac{3}{8}H$ 0.3247595 <i>P</i>	$\frac{H}{2}$ 0.4330127 <i>P</i>	$\frac{5}{8}H$ 0.5412659 <i>P</i>	$0.711325H$ $0.6160254P$	$\frac{3}{4}H$ 0.6495191 <i>P</i>	$\frac{11}{12}H$ 0.7938566 <i>P</i>	$\frac{H}{4}$ 0.8660254 <i>P</i>	$\frac{5}{4}H$ 1.0825318 <i>P</i>
0.2	0.02165	0.04330	0.06495	0.08660	0.10825	0.12321	0.12990	0.15877	0.17321	0.21651
0.25	0.02706	0.05413	0.08119	0.10825	0.13532	0.15401	0.16238	0.19846	0.21651	0.27063
0.3	0.03248	0.06495	0.09743	0.12990	0.16238	0.18481	0.19486	0.23816	0.25981	0.32476
0.35	0.03789	0.07578	0.11367	0.15155	0.18944	0.21561	0.22733	0.27785	0.30311	0.37889
0.4	0.04330	0.08660	0.12990	0.17321	0.21651	0.24541	0.25981	0.31754	0.34641	0.43301
0.45	0.04871	0.09743	0.14614	0.19486	0.24357	0.27721	0.29228	0.35724	0.38971	0.48714
0.5	0.05413	0.10825	0.16238	0.21651	0.27063	0.30801	0.32476	0.39693	0.43301	0.54127
0.6	0.06495	0.12990	0.19486	0.25981	0.32476	0.36962	0.38971	0.47631	0.51962	0.64952
0.7	0.07578	0.15155	0.22733	0.30311	0.37889	0.43122	0.45466	0.55570	0.60622	0.75777
0.75	0.08119	0.16238	0.24357	0.32476	0.40595	0.46202	0.48714	0.59539	0.64952	0.81190
0.8	0.08660	0.17321	0.25981	0.34641	0.43301	0.49282	0.51962	0.63509	0.69282	0.86603
1	0.10825	0.21651	0.32476	0.43301	0.54127	0.61603	0.64952	0.79386	0.86603	1.08253
1.25	0.13532	0.27063	0.40595	0.54127	0.67658	0.77003	0.81190	0.99232	1.08253	1.35316
1.5	0.16238	0.32476	0.48714	0.64952	0.81190	0.92404	0.97428	1.19078	1.29904	1.62380
1.75	0.18944	0.37889	0.56833	0.75777	0.94722	1.07804	1.13666	1.38925	1.51554	1.89443
2	0.21651	0.43301	0.64952	0.86603	1.08253	1.23205	1.29904	1.58771	1.73205	2.16506
2.5	0.27063	0.54127	0.81190	1.08253	1.35316	1.54006	1.62380	1.98464	2.16506	2.70633
3	0.32476	0.64652	0.97428	1.29904	1.62380	1.84808	1.94856	2.38157	2.59808	3.24760
3.5	0.37889	0.75777	1.13666	1.51554	1.89443	2.15609	2.27332	2.77850	3.03109	3.78886
4	0.43301	0.86603	1.29904	1.73205	2.16506	2.46410	2.59808	3.17543	3.46410	4.33013
4.5	0.48714	0.97428	1.46142	1.94856	2.43570	2.77211	2.92284	3.57235	3.89711	4.87139
5	0.54127	1.08253	1.62380	2.16506	2.70633	3.08013	3.24760	3.96928	4.33013	5.41266
5.5	0.59539	1.19079	1.78618	2.38157	2.97696	3.38814	3.57236	4.36621	4.76314	5.95392
6	0.64952	1.29904	1.94856	2.59808	3.24760	3.69615	3.89711	4.76314	5.19615	6.49519
8	0.86603	1.73205	2.59808	3.46410	4.33013	4.92820	5.19615	6.35085	6.92820	8.66025

^a Difference between max theoretical pitch diameter and max minor diameter of external thread and between min theoretical pitch diameter and min minor diameter of internal thread.

^b Difference between min theoretical pitch diameter and min design minor diameter of external thread for 0.125*P* root radius.

^c Difference between max major diameter and max theoretical pitch diameter of internal thread.

All dimensions are in millimeters.

**Table 4. American National Standard Minimum Rounded Root Radius—
M Profile Series ANSI/ASME B1.13M-2005**

Pitch <i>P</i>	Min. Root Radius, 0.125 <i>P</i>	Pitch <i>P</i>	Min. Root Radius, 0.125 <i>P</i>	Pitch <i>P</i>	Min. Root Radius, 0.125 <i>P</i>	Pitch <i>P</i>	Min. Root Radius, 0.125 <i>P</i>
0.2	0.025	0.6	0.075	1.5	0.188	4	0.500
0.25	0.031	0.7	0.088	1.75	0.219	4.5	0.563
0.3	0.038	0.75	0.094	2	0.250	5	0.625
0.35	0.044	0.8	0.100	2.5	0.313	5.5	0.688
0.4	0.050	1	0.125	3	0.375	6	0.750
0.45	0.056	1.25	0.156	3.5	0.438	8	1.000
0.5	0.063

All dimensions are in millimeters.

**Table 5. American National Standard Fine Pitch Metric Thread—M Profile Series
ANSI/ASME B1.13M-2005**

Nom. Size	Pitch			Nom. Size	Pitch			Nom. Size	Pitch			
8	1	27	...	2	...	56	...	2	105	2
10	0.75	1.0	1.25	30	1.5	2	...	60	1.5	...	110	2
12	1	1.5	1.25	33	...	2	...	64	...	2	120	2
14	1.5	35	1.5	65	1.5	...	130	2
15	1	36	...	2	...	70	1.5	...	140	2
16	1.5	39	...	2	...	72	...	2	150	2
17	1	40	1.5	75	1.5	...	160	3
18	1.5	42	...	2	...	80	1.5	2	170	3
20	1	1.5	1.5	45	1.5	85	...	2	180	3
22	1.5	48	...	2	...	90	...	2	190	3
24	2	50	1.5	95	...	2	200	3
25	1.5	55	1.5	100	...	2

All dimensions are in millimeters.

Limits and Fits for Metric Screw Threads — M Profile.—The International (ISO) metric tolerance system is based on a system of limits and fits. The limits of the tolerances on the mating parts together with their allowances (fundamental deviations) determine the fit of the assembly. For simplicity the system is described for cylindrical parts (see *British Standard for Metric ISO Limits and Fits* starting on page 661) but in this Standard it is applied to screw threads. Holes are equivalent to internal threads and shafts to external threads.

Basic Size: This is the zero line or surface at assembly where the interface of the two mating parts have a common reference.*

Upper Deviation: This is the algebraic difference between the maximum limit of size and the basic size. It is designated by the French term “écart supérieur” (ES for internal and *es* for external threads).

Lower Deviation: This is the algebraic difference between the minimum limit of size and the basic size. It is designated by the French term “écart inférieur” (EI for internal and *ei* for external threads).

Fundamental Deviations (Allowances): These are the deviations which are closest to the basic size. In the accompanying figure they would be *EI* and *es*.

* “Basic,” when used to identify a particular dimension in this Standard, such as basic major diameter, refers to the h/H tolerance position (zero fundamental deviation) value.

Tolerance: The tolerance is defined by a series of numerical grades. Each grade provides numerical values for the various nominal sizes corresponding to the standard tolerance for that grade.

In the schematic diagram the tolerance for the external thread is shown as negative. Thus the tolerance plus the fit define the lower deviation (*ei*). The tolerance for the mating internal thread is shown as positive. Thus the tolerance plus the fit defines the upper deviation (*ES*).

Fits: Fits are determined by the fundamental deviations assigned to the mating parts and may be positive or negative. The selected fits can be clearance, transition, or interference. To illustrate the fits schematically, a zero line is drawn to represent the basic size as shown in Fig. 5. By convention, the external thread lies below the zero line and the internal thread lies above it (except for interference fits). This makes the fundamental deviation negative for the external thread and equal to its upper deviation (*es*). The fundamental deviation is positive for the internal thread and equal to its lower deviation (*EI*).

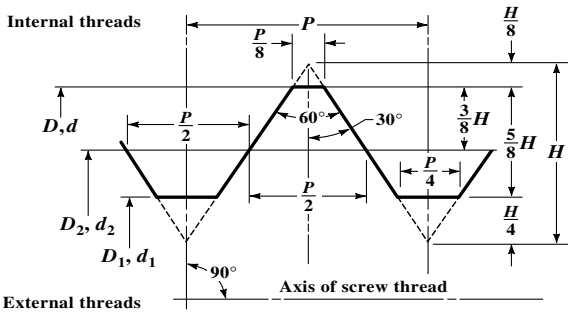

$$H = \frac{\sqrt{3}}{2} \times P = 0.866025P$$

$$0.125H = 0.108253P \quad 0.250H = 0.216506P \quad 0.375H = 0.324760P \quad 0.625H = 0.541266P$$

Fig. 1. Basic M Thread Profile (ISO 68 Basic Profile)

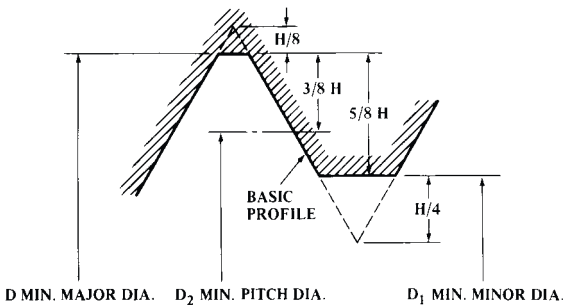

Fig. 2. Internal Thread Design M Profile with No Allowance (Fundamental Deviation) (Maximum Material Condition). For Dimensions see Table 3

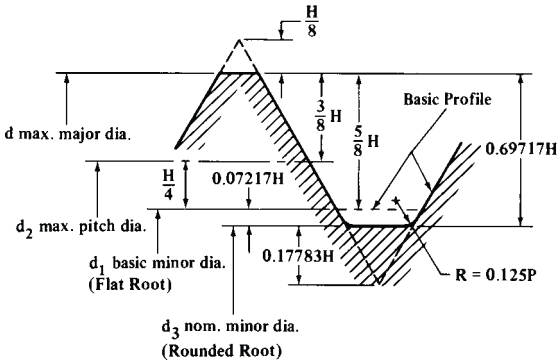

Fig. 3. External Thread Design M Profile with No Allowance (Fundamental Deviation) (Flanks at Maximum Material Condition). For Dimensions see Table 3

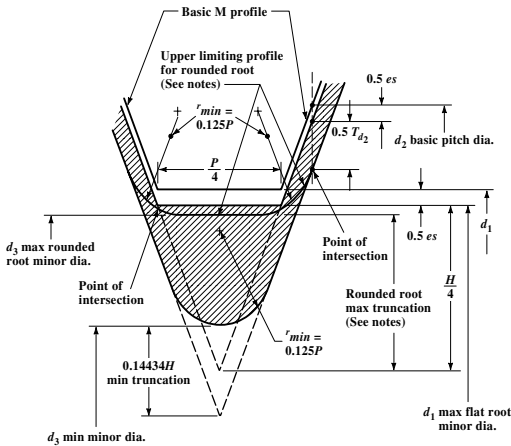

Fig. 4. M Profile, External Thread Root, Upper and Lower Limiting Profiles for $r_{min} = 0.125P$ and for Flat Root (Shown for Tolerance Position g)

Notes:

- 1) "Section lined" portions identify tolerance zone and unshaded portions identify allowance (fundamental deviation).
- 2) The upper limiting profile for rounded root is not a design profile; rather it indicates the limiting acceptable condition for the rounded root which will pass a GO thread gage.
- 3) Max truncation = $\frac{H}{4} - r_{min} \left(1 - \cos \left[60^\circ - \arccos \left(1 - \frac{T_{d2}}{4r_{min}} \right) \right] \right)$

where H = Height of fundamental triangle
 r_{min} = Minimum external thread root radius
 T_{d2} = Tolerance on pitch diameter of external thread

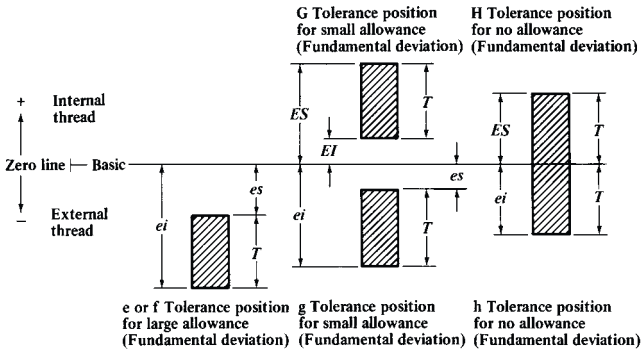

Fig. 5. Metric Tolerance System for Screw Threads

Tolerance Grade: This is indicated by a number. The system provides for a series of tolerance grades for each of the four screw thread parameters: minor diameter, internal thread, D_1 ; major diameter, external thread, d ; pitch diameter, internal thread, D_2 ; and pitch diameter, external thread, d_2 . The tolerance grades for this Standard ANSI B1.13M were selected from those given in ISO 965/1.

Dimension	Tolerance Grades	Table
D_1	4, 5, <u>6</u> , 7, 8	Table 8
d	4, <u>6</u> , 8	Table 9
D_2	4, 5, <u>6</u> , 7, 8	Table 10
d_2	3, <u>4</u> , 5, <u>6</u> , 7, 8, 9	Table 11

Note: The underlined tolerance grades are used with normal length of thread engagement.

Tolerance Position: This position is the allowance (fundamental deviation) and is indicated by a letter. A capital letter is used for internal threads and a lower case letter for external threads. The system provides a series of tolerance positions for internal and external threads. The underlined letters are used in this Standard:

Internal threads	G, <u>H</u>	Table 6
External threads	e, f, <u>g</u> , h	Table 6

Designations of Tolerance Grade, Tolerance Position, and Tolerance Class: The tolerance grade is given first followed by the tolerance position, thus: 4g or 5H. To designate the tolerance class the grade and position of the pitch diameter is shown first followed by that for the major diameter in the case of the external thread or that for the minor diameter in the case of the internal thread, thus 4g6g for an external thread and 5H6H for an internal thread. If the two grades and positions are identical, it is not necessary to repeat the symbols, thus 4g, alone, stands for 4g4g and 5H, alone, stands for 5H5H.

Lead and Flank Angle Tolerances: For acceptance of lead and flank angles of product screw threads, see Section 10 of ANSI/ASME B1.13M-2005.

Short and Long Lengths of Thread Engagement when Gaged with Normal Length Contacts: For short lengths of thread engagement, LE, reduce the pitch diameter tolerance of the external thread by one tolerance grade number. For long lengths of thread engagement, LE, increase the allowance (fundamental deviation) at the pitch diameter of the external thread. Examples of tolerance classes required for normal, short, and long gage length contacts are given in the following table.

For lengths of thread engagement classified as normal, short, and long, see Table 7.

Table 6. American National Standard Allowance (Fundamental Deviation) for Internal and External Metric Threads ISO 965/1 ANSI/ASME B1.13M-2005

Pitch <i>P</i>	Allowance (Fundamental Deviation) ^a					
	Internal Thread <i>D</i> ₂ , <i>D</i> ₁		External Thread <i>d</i> , <i>d</i> ₂			
	G	H ^b	e	f	g ^c	h
	<i>EI</i>	<i>EI</i>	<i>es</i>	<i>es</i>	<i>es</i>	<i>es</i>
0.2	+0.017	0	-0.017	0
0.25	+0.018	0	-0.018	0
0.3	+0.018	0	-0.018	0
0.35	+0.019	0	...	-0.034	-0.019	0
0.4	+0.019	0	...	-0.034	-0.019	0
0.45	+0.020	0	...	-0.035	-0.020	0
0.5	+0.020	0	-0.050	-0.036	-0.020	0
0.6	+0.021	0	-0.053	-0.036	-0.021	0
0.7	+0.022	0	-0.056	-0.038	-0.022	0
0.75	+0.022	0	-0.056	-0.038	-0.022	0
0.8	+0.024	0	-0.060	-0.038	-0.024	0
1	+0.026	0	-0.060	-0.040	-0.026	0
1.25	+0.028	0	-0.063	-0.042	-0.028	0
1.5	+0.032	0	-0.067	-0.045	-0.032	0
1.75	+0.034	0	-0.071	-0.048	-0.034	0
2	+0.038	0	-0.071	-0.052	-0.038	0
2.5	+0.042	0	-0.080	-0.058	-0.042	0
3	+0.048	0	-0.085	-0.063	-0.048	0
3.5	+0.053	0	-0.090	-0.070	-0.053	0
4	+0.060	0	-0.095	-0.075	-0.060	0
4.5	+0.063	0	-0.100	-0.080	-0.063	0
5	+0.071	0	-0.106	-0.085	-0.071	0
5.5	+0.075	0	-0.112	-0.090	-0.075	0
6	+0.080	0	-0.118	-0.095	-0.080	0
8	+0.100	0	-0.140	-0.118	-0.100	0

All dimensions are in millimeters.

^a Allowance is the absolute value of fundamental deviation.

^b Tabulated in this standard for M internal threads.

^c Tabulated in this standard for M external threads.

Normal LE	Short LE	Long LE
6g	5g6g	6e6g
4g6g	3g6g	4e6g
6h ^a	5h6h	6g6h
4h6h ^a	3h6h	4g6h
6H	5H	6G
4H6H	3H6H	4G6G

^a Applies to maximum material functional size (GO thread gage) for plated 6g and 4g6g class threads, respectively.

Material Limits for Coated Threads.—Unless otherwise specified, size limits for standard external tolerance classes 6g and 4g6g apply prior to coating. The external thread allowance may thus be used to accommodate the coating thickness on coated parts, provided that the maximum coating thickness is no more than ¼ of the allowance. Thus, a 6g thread after coating is subject to acceptance using a basic size 6h GO thread gage and a 4g6g thread, a 4h6h or 6h GO thread gage. Minimum material, LO, or NOT-GO gages would be 6g and 4g6g, respectively. Where the external thread has no allowance or the allowance must be maintained after coating, and for standard internal threads, sufficient

**Table 7. American National Standard Length of Metric Thread Engagement
ISO 965/1 and ANSI/ASME B1.13M-2005**

Basic Major Diameter d_{bsc}		Pitch P	Length of Thread Engagement			
			Short LE	Normal LE		Long LE
Over	Up to and incl.		Up to and incl.	Over	Up to and incl.	Over
1.5	2.8	0.2	0.5	0.5	1.5	1.5
		0.25	0.6	0.6	1.9	1.9
		0.35	0.8	0.8	2.6	2.6
		0.4	1	1	3	3
		0.45	1.3	1.3	3.8	3.8
2.8	5.6	0.35	1	1	3	3
		0.5	1.5	1.5	4.5	4.5
		0.6	1.7	1.7	5	5
		0.7	2	2	6	6
		0.75	2.2	2.2	6.7	6.7
5.6	11.2	0.8	2.5	2.5	7.5	7.5
		0.75	2.4	2.4	7.1	7.1
		1	3	3	9	9
		1.25	4	4	12	12
11.2	22.4	1.5	5	5	15	15
		1	3.8	3.8	11	11
		1.25	4.5	4.5	13	13
		1.5	5.6	5.6	16	16
		1.75	6	6	18	18
22.4	45	2	8	8	24	24
		2.5	10	10	30	30
		1	4	4	12	12
		1.5	6.3	6.3	19	19
		2	8.5	8.5	25	25
		3	12	12	36	36
45	90	3.5	15	15	45	45
		4	18	18	53	53
		4.5	21	21	63	63
		1.5	7.5	7.5	22	22
		2	9.5	9.5	28	28
		3	15	15	45	45
		4	19	19	56	56
90	180	5	24	24	71	71
		5.5	28	28	85	85
		6	32	32	95	95
		2	12	12	36	36
		3	18	18	53	53
180	355	4	24	24	71	71
		6	36	36	106	106
		8	45	45	132	132
		3	20	20	60	60
180	355	4	26	26	80	80
		6	40	40	118	118
		8	50	50	150	150
		8	50	50	150	150

All dimensions are in millimeters.

allowance must be provided prior to coating to ensure that finished product threads do not exceed the maximum material limits specified. For thread classes with tolerance position H or h , coating allowances in accordance with Table 6 for position G or g , respectively, should be applied wherever possible.

Dimensional Effect of Coating.—On a cylindrical surface, the effect of coating is to change the diameter by twice the coating thickness. On a 60-degree thread, however, since the coating thickness is measured perpendicular to the thread surface while the pitch diameter is measured perpendicular to the thread axis, the effect of a uniformly coated flank on the pitch diameter is to change it by four times the thickness of the coating on the flank.

External Thread with No Allowance for Coating: To determine gaging limits before coating for a uniformly coated thread, decrease: 1) maximum pitch diameter by four times maximum coating thickness; 2) minimum pitch diameter by four times minimum coating thickness; 3) maximum major diameter by two times maximum coating thickness; and

4) minimum major diameter by two times minimum coating thickness.

External Thread with Only Nominal or Minimum Thickness Coating: If no coating thickness tolerance is given, it is recommended that a tolerance of plus 50 per cent of the nominal or minimum thickness be assumed.

Then, to determine before coating gaging limits for a uniformly coated thread, decrease:

1) maximum pitch diameter by six times coating thickness; 2) minimum pitch diameter by four times coating thickness; 3) maximum major diameter by three times coating thickness; and 4) minimum major diameter by two times coating thickness.

Adjusted Size Limits: It should be noted that the before coating material limit tolerances are less than the tolerance after coating. This is because the coating tolerance consumes some of the product tolerance. In cases there may be insufficient pitch diameter tolerance available in the before coating condition so that additional adjustments and controls will be necessary.

Strength: On small threads (5 mm and smaller) there is a possibility that coating thickness adjustments will cause base material minimum material conditions which may significantly affect strength of externally threaded parts. Limitations on coating thickness or part redesign may then be necessary.

Internal Threads: Standard internal threads provide no allowance for coating thickness.

To determine before coating, gaging limits for a uniformly coated thread, increase:

1) minimum pitch diameter by four times maximum coating thickness, if specified, or by six times minimum or nominal coating thickness when a tolerance is not specified;

2) maximum pitch diameter by four times minimum or nominal coating thickness;

3) minimum minor diameter by two times maximum coating thickness, if specified, or by three times minimum or nominal coating thickness; and 4) maximum minor diameter by two times minimum or nominal coating thickness.

Other Considerations: It is essential to review all possibilities adequately and consider limitations in the threading and coating production processes before finally deciding on the coating process and the allowance required to accommodate the coating. A no-allowance thread after coating must not transgress the basic profile and is, therefore, subject to acceptance using a basic (tolerance position H/h) size GO thread gage.

Formulas for M Profile Screw Thread Limiting Dimensions.—The limiting dimensions for M profile screw threads are calculated from the following formulas.

Internal Threads:

Min major dia. = basic major dia. + EI (Table 6)

Min pitch dia. = basic major dia. - $0.6495191P$ (Table 3) + EI for D_2 (Table 6)

Max pitch dia. = min pitch dia. + TD_2 (Table 10)

Max major dia. = max pitch dia. + $0.7938566P$ (Table 3)

Min minor dia. = min major dia. - $1.0825318P$ (Table 3)

Max minor dia. = min minor dia. + TD_1 (Table 8)

External Threads:

Max major dia. = basic major dia. - es (Table 6) (Note that es is an absolute value.)

Min major dia. = max major dia. - Td (Table 9)

Max pitch dia. = basic major dia. - $0.6495191P$ (Table 3) - es for d_2 (Table 6)

Min pitch dia. = max pitch dia. - Td_2 (Table 11)

Max flat form minor dia. = max pitch dia. - $0.433013P$ (Table 3)

Max rounded root minor dia. = max pitch dia. - $2 \times$ max trunc. (See Fig. 4)

Min rounded root minor dia. = min pitch dia. - $0.616025P$ (Table 3)

Min root radius = $0.125P$

Table 8. ANSI Standard Minor Diameter Tolerances of Internal Metric Threads TD_1 ISO 965/1 ANSI/ASME B1.13M-2005

Pitch P	Tolerance Grade				
	4	5	6 ^a	7	8
0.2	0.038
0.25	0.045	0.056
0.3	0.053	0.067	0.085
0.35	0.063	0.080	0.100
0.4	0.071	0.090	0.112
0.45	0.080	0.100	0.125
0.5	0.090	0.112	0.140	0.180	...
0.6	0.100	0.125	0.160	0.200	...
0.7	0.112	0.140	0.180	0.224	...
0.75	0.118	0.150	0.190	0.236	...
0.8	0.125	0.160	0.200	0.250	0.315
1	0.150	0.190	0.236	0.300	0.375
1.25	0.170	0.212	0.265	0.335	0.425
1.5	0.190	0.236	0.300	0.375	0.475
1.75	0.212	0.265	0.335	0.425	0.530
2	0.236	0.300	0.375	0.475	0.600
2.5	0.280	0.355	0.450	0.560	0.710
3	0.315	0.400	0.500	0.630	0.800
3.5	0.355	0.450	0.560	0.710	0.900
4	0.375	0.475	0.600	0.750	0.950
4.5	0.425	0.530	0.670	0.850	1.060
5	0.450	0.560	0.710	0.900	1.120
5.5	0.475	0.600	0.750	0.950	1.180
6	0.500	0.630	0.800	1.000	1.250
8	0.630	0.800	1.000	1.250	1.600

^aTabulated in this standard for M internal threads.

All dimensions are in millimeters.

Table 9. ANSI Standard Major Diameter Tolerances of External Metric Threads, T_d ISO 965/1 ANSI/ASME B1.13M-2005

Pitch <i>P</i>	Tolerance Grade			Pitch <i>P</i>	Tolerance Grade		
	4	6 ^a	8		4	6 ^a	8
0.2	0.036	0.056	...	1.5	0.150	0.236	0.375
0.25	0.042	0.067	...	1.75	0.170	0.265	0.425
0.3	0.048	0.075	...	2	0.180	0.280	0.450
0.35	0.053	0.085	...	2.5	0.212	0.335	0.530
0.4	0.060	0.095	...	3	0.236	0.375	0.600
0.45	0.063	0.100	...	3.5	0.265	0.425	0.670
0.5	0.067	0.106	...	4	0.300	0.475	0.750
0.6	0.080	0.125	...	4.5	0.315	0.500	0.800
0.7	0.090	0.140	...	5	0.335	0.530	0.850
0.75	0.090	0.140	...	5.5	0.355	0.560	0.900
0.8	0.095	0.150	0.236	6	0.375	0.600	0.950
1	0.112	0.180	0.280	8	0.450	0.710	1.180
1.25	0.132	0.212	0.335

^aTabulated in this standard for M internal threads.

All dimensions are in millimeters.

Table 10. ANSI Standard Pitch-Diameter Tolerances of Internal Metric Thread, TD_2 ISO 965/1 ANSI/ASME B1.13M-2005

Basic Major Diameter, <i>D</i>		Pitch <i>P</i>	Tolerance Grade				
Over	Up to and incl.		4	5	6 ^a	7	8
1.5	2.8	0.2	0.042
		0.25	0.048	0.060
		0.35	0.053	0.067	0.085
		0.4	0.056	0.071	0.090
		0.45	0.060	0.075	0.095
2.8	5.6	0.35	0.056	0.071	0.090
		0.5	0.063	0.080	0.100	0.125	...
		0.6	0.071	0.090	0.112	0.140	...
		0.7	0.075	0.095	0.118	0.150	...
		0.75	0.075	0.095	0.118	0.150	...
		0.8	0.080	0.100	0.125	0.160	0.200
5.6	11.2	0.75	0.085	0.106	0.132	0.170	...
		1	0.095	0.118	0.150	0.190	0.236
		1.25	0.100	0.125	0.160	0.200	0.250
		1.5	0.112	0.140	0.180	0.224	0.280
11.2	22.4	1	0.100	0.125	0.160	0.200	0.250
		1.25	0.112	0.140	0.180	0.224	0.280
		1.5	0.118	0.150	0.190	0.236	0.300
		1.75	0.125	0.160	0.200	0.250	0.315
		2	0.132	0.170	0.212	0.265	0.335
		2.5	0.140	0.180	0.224	0.280	0.355
22.4	45	1	0.106	0.132	0.170	0.212	...
		1.5	0.125	0.160	0.200	0.250	0.315
		2	0.140	0.180	0.224	0.280	0.355
		3	0.170	0.212	0.265	0.335	0.425
		3.5	0.180	0.224	0.280	0.355	0.450
		4	0.190	0.236	0.300	0.375	0.475
		4.5	0.200	0.250	0.315	0.400	0.500
45	90	1.5	0.132	0.170	0.212	0.265	0.335
		2	0.150	0.190	0.236	0.300	0.375
		3	0.180	0.224	0.280	0.355	0.450
		4	0.200	0.250	0.315	0.400	0.500
		5	0.212	0.265	0.335	0.425	0.530
		5.5	0.224	0.280	0.355	0.450	0.560
		6	0.236	0.300	0.375	0.475	0.600

Table 10. (Continued) ANSI Standard Pitch-Diameter Tolerances of Internal Metric Thread, TD_2 ISO 965/1 ANSI/ASME B1.13M-2005

Basic Major Diameter, D		Pitch P	Tolerance Grade				
Over	Up to and incl.		4	5	6 ^a	7	8
90	180	2	0.160	0.200	0.250	0.315	0.400
		3	0.190	0.236	0.300	0.375	0.475
		4	0.212	0.265	0.335	0.425	0.530
		6	0.250	0.315	0.400	0.500	0.630
180	355	8	0.280	0.355	0.450	0.560	0.710
		3	0.212	0.265	0.335	0.425	0.530
		4	0.236	0.300	0.375	0.475	0.600
		6	0.265	0.335	0.425	0.530	0.670
8	0.300	0.375	0.475	0.600	0.750		

^a Tabulated in this standard for M threads.
All dimensions are in millimeters.

Table 11. ANSI Standard Pitch-Diameter Tolerances of External Metric Threads, Td_2 ISO 965/1 ANSI/ASME B1.13M-2005

Basic Major Diameter, d		Pitch P	Tolerance Grade						
Over	Up to and incl.		3	4 ^a	5	6 ^a	7	8	9
1.5	2.8	0.2	0.025	0.032	0.040	0.050
		0.25	0.028	0.036	0.045	0.056
		0.35	0.032	0.040	0.050	0.063	0.080
		0.4	0.034	0.042	0.053	0.067	0.085
		0.45	0.036	0.045	0.056	0.071	0.090
2.8	5.6	0.35	0.034	0.042	0.053	0.067	0.085
		0.5	0.038	0.048	0.060	0.075	0.095
		0.6	0.042	0.053	0.067	0.085	0.106
		0.7	0.045	0.056	0.071	0.090	0.112
		0.75	0.045	0.056	0.071	0.090	0.112
5.6	11.2	0.8	0.048	0.060	0.075	0.095	0.118	0.150	0.190
		0.75	0.050	0.063	0.080	0.100	0.125
		1	0.056	0.071	0.090	0.112	0.140	0.180	0.224
		1.25	0.060	0.075	0.095	0.118	0.150	0.190	0.236
11.2	22.4	1.5	0.067	0.085	0.106	0.132	0.170	0.212	0.265
		1	0.060	0.075	0.095	0.118	0.150	0.190	0.236
		1.25	0.067	0.085	0.106	0.132	0.170	0.212	0.265
		1.5	0.071	0.090	0.112	0.140	0.180	0.224	0.280
		1.75	0.075	0.095	0.118	0.150	0.190	0.236	0.300
22.4	45	2	0.080	0.100	0.125	0.160	0.200	0.250	0.315
		2.5	0.085	0.106	0.132	0.170	0.212	0.265	0.335
		1	0.063	0.080	0.100	0.125	0.160	0.200	0.250
		1.5	0.075	0.095	0.118	0.150	0.190	0.236	0.300
		2	0.085	0.106	0.132	0.170	0.212	0.265	0.335
		3	0.100	0.125	0.160	0.200	0.250	0.315	0.400
45	90	3.5	0.106	0.132	0.170	0.212	0.265	0.335	0.425
		4	0.112	0.140	0.180	0.224	0.280	0.355	0.450
		4.5	0.118	0.150	0.190	0.236	0.300	0.375	0.475
		1.5	0.080	0.100	0.125	0.160	0.200	0.250	0.315
		2	0.090	0.112	0.140	0.180	0.224	0.280	0.355
		3	0.106	0.132	0.170	0.212	0.265	0.335	0.425
		4	0.118	0.150	0.190	0.236	0.300	0.375	0.475
90	180	5	0.125	0.160	0.200	0.250	0.315	0.400	0.500
		5.5	0.132	0.170	0.212	0.265	0.335	0.425	0.530
		6	0.140	0.180	0.224	0.280	0.355	0.450	0.560
		2	0.095	0.118	0.150	0.190	0.236	0.300	0.375
		3	0.112	0.140	0.180	0.224	0.280	0.355	0.450
		4	0.125	0.160	0.200	0.250	0.315	0.400	0.500
		6	0.150	0.190	0.236	0.300	0.375	0.475	0.600
8	0.170	0.212	0.265	0.335	0.425	0.530	0.670		

Table 11. (Continued) ANSI Standard Pitch-Diameter Tolerances of External Metric Threads, Td_2 ISO 965/1 ANSI/ASME B1.13M-2005

Basic Major Diameter, d		Pitch P	Tolerance Grade						
Over	Up to and incl.		3	4 ^a	5	6 ^a	7	8	9
180	355	3	0.125	0.160	0.200	0.250	0.315	0.400	0.500
		4	0.140	0.180	0.224	0.280	0.355	0.450	0.560
		6	0.160	0.200	0.250	0.315	0.400	0.500	0.630
		8	0.180	0.224	0.280	0.355	0.450	0.560	0.710

^aTabulated in this Standard for M threads.
 All dimensions are in millimeters.

Tolerance Grade Comparisons.—The approximate ratios of the tolerance grades shown in Tables 8, 9, 10, and 11 in terms of Grade 6 are as follows:

Minor Diameter Tolerance of Internal Thread: Grade 6 is TD_1 (Table 8); Grade 4 is 0.63 TD_1 (6); Grade 5 is 0.8 TD_1 (6); Grade 7 is 1.25 TD_1 (6); and Grade 8 is 1.6 TD_1 (6).

Pitch Diameter Tolerance of Internal Thread: Td_2 (Table 10): Grade 4 is 0.85 Td_2 (6); Grade 5 is 1.06 Td_2 (6); Grade 6 is 1.32 Td_2 (6); Grade 7 is 1.7 Td_2 (6); and Grade 8 is 2.12 Td_2 (6). It should be noted that these ratios are in terms of the Grade 6 pitch diameter tolerance for the external thread.

Major Diameter Tolerance of External Thread: Td (6) (Table 9): Grade 4 is 0.63 Td (6); and Grade 8 is 1.6 Td (6).

Pitch Diameter Tolerance of External Thread: Td_2 (Table 11): Grade 3 is 0.5 Td_2 (6); Grade 4 is 0.63 Td_2 (6); Grade 5 is 0.8 Td_2 (6); Grade 7 is 1.25 Td_2 (6); Grade 8 is 1.6 Td_2 (6); and Grade 9 is 2 Td_2 (6).

Standard M Profile Screw Threads, Limits of Size.—The limiting M profile for internal threads is shown in Fig. 6 with associated dimensions for standard sizes in Table 12. The limiting M profiles for external threads are shown in Fig. 7 with associated dimensions for standard sizes in Table 13.

If the required values are not listed in these tables, they may be calculated using the data in Tables 3, 6, 7, 8, 9, 10, and 11 together with the preceding formulas. If the required data are not included in any of the tables listed above, reference should be made to Sections 6 and 9.3 of ANSI/ASME B1.13M, which gives design formulas.

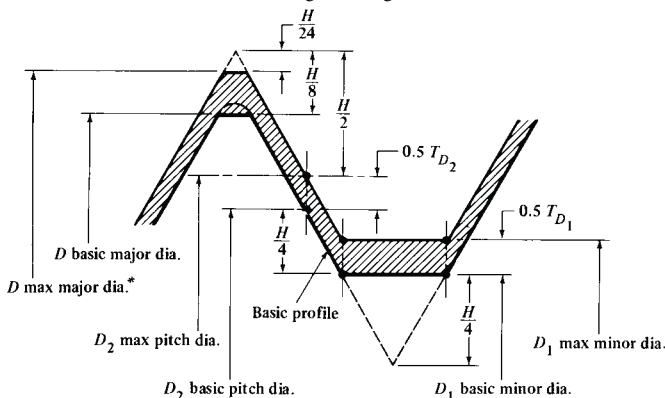

Fig. 6. Internal Thread — Limiting M Profile. Tolerance Position H

METRIC SCREW THREADS M PROFILE

Note: "Section Lined" portions identify tolerance zone.

*Dimension D in Fig. 6 is used in the design of tools, etc. For internal threads it is not normally specified. Generally, major diameter acceptance is based on maximum material condition gaging.

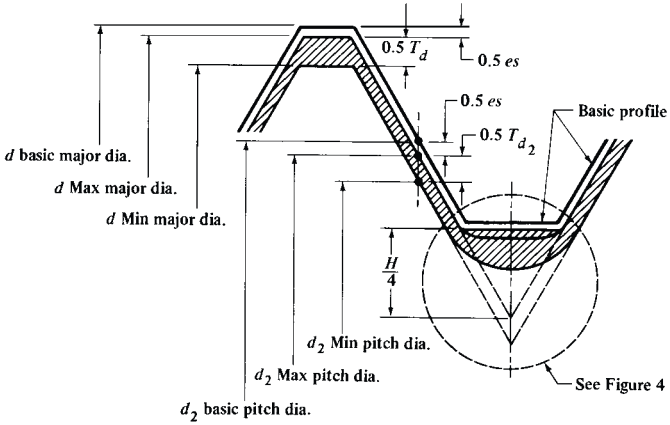

Fig. 7. External Thread — Limiting M Profile. Tolerance Position g

Note: "Section Lined" portions identify tolerance zone and unshaded portions identify allowance (fundamental deviation.)

Table 12. Internal Metric Thread - M Profile Limiting Dimensions, ANSI/ASME B1.13M-2005

Basic Thread Designation	Toler. Class	Minor Diameter D_1		Pitch Diameter D_2			Major Diameter D	
		Min	Max	Min	Max	Tol	Min	Max ^a
M1.6 × 0.35	6H	1.221	1.321	1.373	1.458	0.085	1.600	1.736
M2 × 0.4	6H	1.567	1.679	1.740	1.830	0.090	2.000	2.148
M2.5 × 0.45	6H	2.013	2.138	2.208	2.303	0.095	2.500	2.660
M3 × 0.5	6H	2.459	2.599	2.675	2.775	0.100	3.000	3.172
M3.5 × 0.6	6H	2.850	3.010	3.110	3.222	0.112	3.500	3.698
M4 × 0.7	6H	3.242	3.422	3.545	3.663	0.118	4.000	4.219
M5 × 0.8	6H	4.134	4.334	4.480	4.605	0.125	5.000	5.240
M6 × 1	6H	4.917	5.153	5.350	5.500	0.150	6.000	6.294
M8 × 1.25	6H	6.647	6.912	7.188	7.348	0.160	8.000	8.340
M8 × 1	6H	6.917	7.153	7.350	7.500	0.150	8.000	8.294
M10 × 0.75	6H	9.188	9.378	9.513	9.645	0.132	10.000	10.240
M10 × 1	6H	8.917	9.153	9.350	9.500	0.150	10.000	10.294
M10 × 1.5	6H	8.376	8.676	9.026	9.206	0.180	10.000	10.397
M10 × 1.25	6H	8.647	8.912	9.188	9.348	0.160	10.000	10.340
M12 × 1.75	6H	10.106	10.441	10.863	11.063	0.200	12.000	12.452
M12 × 1.5	6H	10.376	10.676	11.026	11.216	0.190	12.000	12.407
M12 × 1.25	6H	10.647	10.912	11.188	11.368	0.180	12.000	12.360
M12 × 1	6H	10.917	11.153	11.350	11.510	0.160	12.000	12.304
M14 × 2	6H	11.835	12.210	12.701	12.913	0.212	14.000	14.501
M14 × 1.5	6H	12.376	12.676	13.026	13.216	0.190	14.000	14.407
M15 × 1	6H	13.917	14.153	14.350	14.510	0.160	15.000	15.304
M16 × 2	6H	13.835	14.210	14.701	14.913	0.212	16.000	16.501
M16 × 1.5	6H	14.376	14.676	15.026	15.216	0.190	16.000	16.407
M17 × 1	6H	15.917	16.153	16.350	16.510	0.160	17.000	17.304
M18 × 1.5	6H	16.376	16.676	17.026	17.216	0.190	18.000	18.407
M20 × 2.5	6H	17.294	17.744	18.376	18.600	0.224	20.000	20.585
M20 × 1.5	6H	18.376	18.676	19.026	19.216	0.190	20.000	20.407

**Table 12. (Continued) Internal Metric Thread - M Profile Limiting Dimensions,
 ANSI/ASME B1.13M-2005**

Basic Thread Designation	Toler. Class	Minor Diameter D_1		Pitch Diameter D_2			Major Diameter D	
		Min	Max	Min	Max	Tol	Min	Max ^a
M20 × 1	6H	18.917	19.153	19.350	19.510	0.160	20.000	20.304
M22 × 2.5	6H	19.294	19.744	20.376	20.600	0.224	22.000	22.585
M22 × 1.5	6H	20.376	20.676	21.026	21.216	0.190	22.000	22.407
M24 × 3	6H	20.752	21.252	22.051	22.316	0.265	24.000	24.698
M24 × 2	6H	21.835	22.210	22.701	22.925	0.224	24.000	24.513
M25 × 1.5	6H	23.376	23.676	24.026	24.226	0.200	25.000	25.417
M27 × 3	6H	23.752	24.252	25.051	25.316	0.265	27.000	27.698
M27 × 2	6H	24.835	25.210	25.701	25.925	0.224	27.000	27.513
M30 × 3.5	6H	26.211	26.711	27.727	28.007	0.280	30.000	30.786
M30 × 2	6H	27.835	28.210	28.701	28.925	0.224	30.000	30.513
M30 × 1.5	6H	28.376	28.676	29.026	29.226	0.200	30.000	30.417
M33 × 2	6H	30.835	31.210	31.701	31.925	0.224	33.000	33.513
M35 × 1.5	6H	33.376	33.676	34.026	34.226	0.200	35.000	35.417
M36 × 4	6H	31.670	32.270	33.402	33.702	0.300	36.000	36.877
M36 × 2	6H	33.835	34.210	34.701	34.925	0.224	36.000	36.513
M39 × 2	6H	36.835	37.210	37.701	37.925	0.224	39.000	39.513
M40 × 1.5	6H	38.376	38.676	39.026	39.226	0.200	40.000	40.417
M42 × 4.5	6H	37.129	37.799	39.077	39.392	0.315	42.000	42.964
M42 × 2	6H	39.835	40.210	40.701	40.925	0.224	42.000	42.513
M45 × 1.5	6H	43.376	43.676	44.026	44.226	0.200	45.000	45.417
M48 × 5	6H	42.587	43.297	44.752	45.087	0.335	48.000	49.056
M48 × 2	6H	45.835	46.210	46.701	46.937	0.236	48.000	48.525
M50 × 1.5	6H	48.376	48.676	49.026	49.238	0.212	50.000	50.429
M55 × 1.5	6H	53.376	53.676	54.026	54.238	0.212	55.000	55.429
M56 × 5.5	6H	50.046	50.796	52.428	52.783	0.355	56.000	57.149
M56 × 2	6H	53.835	54.210	54.701	54.937	0.236	56.000	56.525
M60 × 1.5	6H	58.376	58.676	59.026	59.238	0.212	60.000	60.429
M64 × 6	6H	57.505	58.305	60.103	60.478	0.375	64.000	65.241
M64 × 2	6H	61.835	62.210	62.701	62.937	0.236	64.000	64.525
M65 × 1.5	6H	63.376	63.676	64.026	64.238	0.212	65.000	65.429
M70 × 1.5	6H	68.376	68.676	69.026	69.238	0.212	70.000	70.429
M72 × 6	6H	65.505	66.305	68.103	68.478	0.375	72.000	73.241
M72 × 2	6H	69.835	70.210	70.701	70.937	0.236	72.000	72.525
M75 × 1.5	6H	73.376	73.676	74.026	74.238	0.212	75.000	75.429
M80 × 6	6H	73.505	74.305	76.103	76.478	0.375	80.000	81.241
M80 × 2	6H	77.835	78.210	78.701	78.937	0.236	80.000	80.525
M80 × 1.5	6H	78.376	78.676	79.026	79.238	0.212	80.000	80.429
M85 × 2	6H	82.835	83.210	83.701	83.937	0.236	85.000	85.525
M90 × 6	6H	83.505	84.305	86.103	86.478	0.375	90.000	91.241
M90 × 2	6H	87.835	88.210	88.701	88.937	0.236	90.000	90.525
M95 × 2	6H	92.835	93.210	93.701	93.951	0.250	95.000	95.539
M100 × 6	6H	93.505	94.305	96.103	96.503	0.400	100.000	101.266
M100 × 2	6H	97.835	98.210	98.701	98.951	0.250	100.000	100.539
M105 × 2	6H	102.835	103.210	103.701	103.951	0.250	105.000	105.539
M110 × 2	6H	107.835	108.210	108.701	108.951	0.250	110.000	110.539
M120 × 2	6H	117.835	118.210	118.701	118.951	0.250	120.000	120.539
M130 × 2	6H	127.835	128.210	128.701	128.951	0.250	130.000	130.539
M140 × 2	6H	137.835	138.210	138.701	138.951	0.250	140.000	140.539
M150 × 2	6H	147.835	148.210	148.701	148.951	0.250	150.000	150.539
M160 × 3	6H	156.752	157.252	158.051	158.351	0.300	160.000	160.733
M170 × 3	6H	166.752	167.252	168.051	168.351	0.300	170.000	170.733
M180 × 3	6H	176.752	177.252	178.051	178.351	0.300	180.000	180.733
M190 × 3	6H	186.752	187.252	188.051	188.386	0.335	190.000	190.768
M200 × 3	6H	196.752	197.252	198.051	198.386	0.335	200.000	200.768

^a This reference dimension is used in design of tools, etc., and is not normally specified. Generally, major diameter acceptance is based upon maximum material condition gaging.

All dimensions are in millimeters.

Table 13. External Metric Thread—M Profile Limiting Dimensions ANSI/ASME B1.13M-2005

Basic Thread Designation	Tol. Class	Allowance ^a <i>a_s</i>	Major Diameter ^b <i>d</i>		Pitch Diameter ^{b c} <i>d₂</i>			Minor Dia. ^b <i>d₁</i>	Minor Dia. ^d <i>d₃</i>
			Max.	Min.	Max.	Min.	Tol.	Max.	Min.
M1.6 × 0.35	6g	0.019	1.581	1.496	1.354	1.291	0.063	1.202	1.075
M1.6 × 0.35	6h	0.000	1.600	1.515	1.373	1.310	0.063	1.221	1.094
M1.6 × 0.35	4g6g	0.019	1.581	1.496	1.354	1.314	0.040	1.202	1.098
M2 × 0.4	6g	0.019	1.981	1.886	1.721	1.654	0.067	1.548	1.408
M2 × 0.4	6h	0.000	2.000	1.905	1.740	1.673	0.067	1.567	1.427
M2 × 0.4	4g6g	0.019	1.981	1.886	1.721	1.679	0.042	1.548	1.433
M2.5 × 0.45	6g	0.020	2.480	2.380	2.188	2.117	0.071	1.993	1.840
M2.5 × 0.45	6h	0.000	2.500	2.400	2.208	2.137	0.071	2.013	1.860
M2.5 × 0.45	4g6g	0.020	2.480	2.380	2.188	2.143	0.045	1.993	1.866
M3 × 0.5	6g	0.020	2.980	2.874	2.655	2.580	0.075	2.438	2.272
M3 × 0.5	6h	0.000	3.000	2.894	2.675	2.600	0.075	2.458	2.292
M3 × 0.5	4g6g	0.020	2.980	2.874	2.655	2.607	0.048	2.438	2.299
M3.5 × 0.6	6g	0.021	3.479	3.354	3.089	3.004	0.085	2.829	2.634
M3.5 × 0.6	6h	0.000	3.500	3.375	3.110	3.025	0.085	2.850	2.655
M3.5 × 0.6	4g6g	0.021	3.479	3.354	3.089	3.036	0.053	2.829	2.666
M4 × 0.7	6g	0.022	3.978	3.838	3.523	3.433	0.090	3.220	3.002
M4 × 0.7	6h	0.000	4.000	3.860	3.545	3.455	0.090	3.242	3.024
M4 × 0.7	4g6g	0.022	3.978	3.838	3.523	3.467	0.056	3.220	3.036
M5 × 0.8	6g	0.024	4.976	4.826	4.456	4.361	0.095	4.110	3.868
M5 × 0.8	6h	0.000	5.000	4.850	4.480	4.385	0.095	4.134	3.892
M5 × 0.8	4g6g	0.024	4.976	4.826	4.456	4.396	0.060	4.110	3.903
M6 × 1	6g	0.026	5.974	5.794	5.324	5.212	0.112	4.891	4.596
M6 × 1	6h	0.000	6.000	5.820	5.350	5.238	0.112	4.917	4.622
M6 × 1	4g6g	0.026	5.974	5.794	5.324	5.253	0.071	4.891	4.637
M8 × 1.25	6g	0.028	7.972	7.760	7.160	7.042	0.118	6.619	6.272
M8 × 1.25	6h	0.000	8.000	7.788	7.188	7.070	0.118	6.647	6.300
M8 × 1.25	4g6g	0.028	7.972	7.760	7.160	7.085	0.075	6.619	6.315
M8 × 1	6g	0.026	7.974	7.794	7.324	7.212	0.112	6.891	6.596
M8 × 1	6h	0.000	8.000	7.820	7.350	7.238	0.112	6.917	6.622
M8 × 1	4g6g	0.026	7.974	7.794	7.324	7.253	0.071	6.891	6.637
M10 × 1.5	6g	0.032	9.968	9.732	8.994	8.862	0.132	8.344	7.938
M10 × 1.5	6h	0.000	10.000	9.764	9.026	8.894	0.132	8.376	7.970
M10 × 1.5	4g6g	0.032	9.968	9.732	8.994	8.909	0.085	8.344	7.985
M10 × 1.25	6g	0.028	9.972	9.760	9.160	9.042	0.118	8.619	8.272
M10 × 1.25	6h	0.000	10.000	9.788	9.188	9.070	0.118	8.647	8.300
M10 × 1.25	4g6g	0.028	9.972	9.760	9.160	9.085	0.075	8.619	8.315
M10 × 1	6g	0.026	9.974	9.794	9.324	9.212	0.112	8.891	8.596
M10 × 1	6h	0.000	10.000	9.820	9.350	9.238	0.112	8.917	8.622
M10 × 1	4g6g	0.026	9.974	9.794	9.324	9.253	0.071	8.891	8.637
M10 × 0.75	6g	0.022	9.978	9.838	9.491	9.391	0.100	9.166	8.929
M10 × 0.75	6h	0.000	10.000	9.860	9.513	9.413	0.100	9.188	8.951
M10 × 0.75	4g6g	0.022	9.978	9.838	9.491	9.428	0.063	9.166	8.966
M12 × 1.75	6g	0.034	11.966	11.701	10.829	10.679	0.150	10.071	9.601
M12 × 1.75	6h	0.000	12.000	11.735	10.863	10.713	0.150	10.105	9.635
M12 × 1.75	4g6g	0.034	11.966	11.701	10.829	10.734	0.095	10.071	9.656
M12 × 1.5	6g	0.032	11.968	11.732	10.994	10.854	0.140	10.344	9.930
M12 × 1.5	6h	0.000	12.000	11.764	11.026	10.886	0.140	10.376	9.962
M12 × 1.5	4g6g	0.032	11.968	11.732	10.994	10.904	0.090	10.344	9.980
M12 × 1.25	6g	0.028	11.972	11.760	11.160	11.028	0.132	10.619	10.258
M12 × 1.25	6h	0.000	12.000	11.788	11.188	11.056	0.132	10.647	10.286
M12 × 1.25	4g6g	0.028	11.972	11.760	11.160	11.075	0.085	10.619	10.305
M12 × 1	6g	0.026	11.974	11.794	11.324	11.206	0.118	10.891	10.590
M12 × 1	6h	0.000	12.000	11.820	11.350	11.232	0.118	10.917	10.616
M12 × 1	4g6g	0.026	11.974	11.794	11.324	11.249	0.075	10.891	10.633
M14 × 2	6g	0.038	13.962	13.682	12.663	12.503	0.160	11.797	11.271
M14 × 2	6h	0.000	14.000	13.720	12.701	12.541	0.160	11.835	11.309
M14 × 2	4g6g	0.038	13.962	13.682	12.663	12.563	0.100	11.797	11.331
M14 × 1.5	6g	0.032	13.968	13.732	12.994	12.854	0.140	12.344	11.930
M14 × 1.5	6h	0.000	14.000	13.764	13.026	12.886	0.140	12.376	11.962
M14 × 1.5	4g6g	0.032	13.968	13.732	12.994	12.904	0.090	12.344	11.980
M15 × 1	6g	0.026	14.974	14.794	14.324	14.206	0.118	13.891	13.590
M15 × 1	6h	0.000	15.000	14.820	14.350	14.232	0.118	13.917	13.616
M15 × 1	4g6g	0.026	14.974	14.794	14.324	14.249	0.075	13.891	13.633

Table 13. (Continued) External Metric Thread—M Profile Limiting Dimensions ANSI/ASME B1.13M-2005

Basic Thread Designation	Tol. Class	Allowance ^e e _s	Major Diameter ^b d		Pitch Diameter ^{b c} d ₂			Minor Dia. ^b d ₁	Minor Dia. ^d d ₃
			Max.	Min.	Max.	Min.	Tol.	Max.	Min.
			M16 × 2	6g	0.038	15.962	15.682	14.663	14.503
M16 × 2	6h	0.000	16.000	15.720	14.701	14.541	0.160	13.835	13.309
M16 × 2	4g6g	0.038	15.962	15.682	14.663	14.563	0.100	13.797	13.331
M16 × 1.5	6g	0.032	15.968	15.732	14.994	14.854	0.140	14.344	13.930
M16 × 1.5	6h	0.000	16.000	15.764	15.026	14.886	0.140	14.376	13.962
M16 × 1.5	4g6g	0.032	15.968	15.732	14.994	14.904	0.090	14.344	13.980
M17 × 1	6g	0.026	16.974	16.794	16.324	16.206	0.118	15.891	15.590
M17 × 1	6h	0.000	17.000	16.820	16.350	16.232	0.118	15.917	15.616
M17 × 1	4g6g	0.026	16.974	16.794	16.324	16.249	0.075	15.891	15.633
M18 × 1.5	6g	0.032	17.968	17.732	16.994	16.854	0.140	16.344	15.930
M18 × 1.5	6h	0.000	18.000	17.764	17.026	16.886	0.140	16.376	15.962
M18 × 1.5	4g6g	0.032	17.968	17.732	16.994	16.904	0.090	16.344	15.980
M20 × 2.5	6g	0.042	19.958	19.623	18.334	18.164	0.170	17.251	16.624
M20 × 2.5	6h	0.000	20.000	19.665	18.376	18.206	0.170	17.293	16.666
M20 × 2.5	4g6g	0.042	19.958	19.623	18.334	18.228	0.106	17.251	16.688
M20 × 1.5	6g	0.032	19.968	19.732	18.994	18.854	0.140	18.344	17.930
M20 × 1.5	6h	0.000	20.000	19.764	19.026	18.886	0.140	18.376	17.962
M20 × 1.5	4g6g	0.032	19.968	19.732	18.994	18.904	0.090	18.344	17.980
M20 × 1	6g	0.026	19.974	19.794	19.324	19.206	0.118	18.891	18.590
M20 × 1	6h	0.000	20.000	19.820	19.350	19.232	0.118	18.917	18.616
M20 × 1	4g6g	0.026	19.974	19.794	19.324	19.249	0.075	18.891	18.633
M22 × 2.5	6g	0.042	21.958	21.623	20.334	20.164	0.170	19.251	18.624
M22 × 2.5	6h	0.000	22.000	21.665	20.376	20.206	0.170	19.293	18.666
M22 × 1.5	6g	0.032	21.968	21.732	20.994	20.854	0.140	20.344	19.930
M22 × 1.5	6h	0.000	22.000	21.764	21.026	20.886	0.140	20.376	19.962
M22 × 1.5	4g6g	0.032	21.968 ^f	21.732	20.994	20.904	0.090	20.344	19.980
M24 × 3	6g	0.048	23.952	23.577	22.003	21.803	0.200	20.704	19.955
M24 × 3	6h	0.000	24.000	23.625	22.051	21.851	0.200	20.752	20.003
M24 × 3	4g6g	0.048	23.952	23.577	22.003	21.878	0.125	20.704	20.030
M24 × 2	6g	0.038	23.962	23.682	22.663	22.493	0.170	21.797	21.261
M24 × 2	6h	0.000	24.000	23.720	22.701	22.531	0.170	21.835	21.299
M24 × 2	4g6g	0.038	23.962	23.682	22.663	22.557	0.106	21.797	21.325
M25 × 1.5	6g	0.032	24.968	24.732	23.994	23.844	0.150	23.344	22.920
M25 × 1.5	6h	0.000	25.000	24.764	24.026	23.876	0.150	23.376	22.952
M25 × 1.5	4g6g	0.032	24.968	24.732	23.994	23.899	0.095	23.344	22.975
M27 × 3	6g	0.048	26.952	26.577	25.003	24.803	0.200	23.704	22.955
M27 × 3	6h	0.000	27.000	26.625	25.051	24.851	0.200	23.752	23.003
M27 × 2	6g	0.038	26.962	26.682	25.663	25.493	0.170	24.797	24.261
M27 × 2	6h	0.000	27.000	26.720	25.701	25.531	0.170	24.835	24.299
M27 × 2	4g6g	0.038	26.962	26.682	25.663	25.557	0.106	24.797	24.325
M30 × 3.5	6g	0.053	29.947	29.522	27.674	27.462	0.212	26.158	25.306
M30 × 3.5	6h	0.000	30.000	29.575	27.727	27.515	0.212	26.211	25.359
M30 × 3.5	4g6g	0.053	29.947	29.522	27.674	27.542	0.132	26.158	25.386
M30 × 2	6g	0.038	29.962	29.682	28.663	28.493	0.170	27.797	27.261
M30 × 2	6h	0.000	30.000	29.720	28.701	28.531	0.170	27.835	27.299
M30 × 2	4g6g	0.038	29.962	29.682	28.663	28.557	0.106	27.797	27.325
M30 × 1.5	6g	0.032	29.968	29.732	28.994	28.844	0.150	28.344	27.920
M30 × 1.5	6h	0.000	30.000	29.764	29.026	28.876	0.150	28.376	27.952
M30 × 1.5	4g6g	0.032	29.968	29.732	28.994	28.899	0.095	28.344	27.975
M33 × 2	6g	0.038	32.962	32.682	31.663	31.493	0.170	30.797	30.261
M33 × 2	6h	0.000	33.000	32.720	31.701	31.531	0.170	30.835	30.299
M33 × 2	4g6g	0.038	32.962	32.682	31.663	31.557	0.106	30.797	30.325
M35 × 1.5	6g	0.032	34.968	34.732	33.994	33.844	0.150	33.344	32.920
M35 × 1.5	6h	0.000	35.000	34.764	34.026	33.876	0.150	33.376	32.952
M36 × 4	6g	0.060	35.940	35.465	33.342	33.118	0.224	31.610	30.654
M36 × 4	6h	0.000	36.000	35.525	33.402	33.178	0.224	31.670	30.714
M36 × 4	4g6g	0.060	35.940	35.465	33.342	33.202	0.140	31.610	30.738
M36 × 2	6g	0.038	35.962	35.682	34.663	34.493	0.170	33.797	33.261
M36 × 2	6h	0.000	36.000	35.720	34.701	34.531	0.170	33.835	33.299
M36 × 2	4g6g	0.038	35.962	35.682	34.663	34.557	0.106	33.797	33.325
M39 × 2	6g	0.038	38.962	38.682	37.663	37.493	0.170	36.797	36.261
M39 × 2	6h	0.000	39.000	38.720	37.701	37.531	0.170	36.835	36.299
M39 × 2	4g6g	0.038	38.962	38.682	37.663	37.557	0.106	36.797	36.325
M40 × 1.5	6g	0.032	39.968	39.732	38.994	38.844	0.150	38.344	37.920

Table 13. (Continued) External Metric Thread—M Profile Limiting Dimensions ANSI/ASME B1.13M-2005

Basic Thread Designation	Tol. Class	Allowance ^a <i>e_s</i>	Major Diameter ^b <i>d</i>		Pitch Diameter ^{b c} <i>d₂</i>			Minor Dia. ^b <i>d₁</i>	Minor Dia. ^d <i>d₃</i>
			Max.	Min.	Max.	Min.	Tol.	Max.	Min.
			M40 × 1.5	6h	0.000	40.000	39.764	39.026	38.876
M40 × 1.5	4g6g	0.032	39.968	39.732	38.994	38.899	0.095	38.344	37.975
M42 × 4.5	6g	0.063	41.937	41.437	39.014	38.778	0.236	37.065	36.006
M42 × 4.5	6h	0.000	42.000	41.500	39.077	38.841	0.236	37.128	36.069
M42 × 4.5	4g6g	0.063	41.937	41.437	39.014	38.864	0.150	37.065	36.092
M42 × 2	6g	0.038	41.962	41.682	40.663	40.493	0.170	39.797	39.261
M42 × 2	6h	0.000	42.000	41.720	40.701	40.531	0.170	39.835	39.299
M42 × 2	4g6g	0.038	41.962	41.682	40.663	40.557	0.106	39.797	39.325
M45 × 1.5	6g	0.032	44.968	44.732	43.994	43.844	0.150	43.344	42.920
M45 × 1.5	6h	0.000	45.000	44.764	44.026	43.876	0.150	43.376	42.952
M45 × 1.5	4g6g	0.032	44.968	44.732	43.994	43.899	0.095	43.344	42.975
M48 × 5	6g	0.071	47.929	47.399	44.681	44.431	0.250	42.516	41.351
M48 × 5	6h	0.000	48.000	47.470	44.752	44.502	0.250	42.587	41.422
M48 × 5	4g6g	0.071	47.929	47.399	44.681	44.521	0.160	42.516	41.441
M48 × 2	6g	0.038	47.962	47.682	46.663	46.483	0.180	45.797	45.251
M48 × 2	6h	0.000	48.000	47.720	46.701	46.521	0.180	45.835	45.289
M48 × 2	4g6g	0.038	47.962	47.682	46.663	46.551	0.112	45.797	45.319
M50 × 1.5	6g	0.032	49.968	49.732	48.994	48.834	0.160	48.344	47.910
M50 × 1.5	6h	0.000	50.000	49.764	49.026	48.866	0.160	48.376	47.942
M50 × 1.5	4g6g	0.032	49.968	49.732	48.994	48.894	0.100	48.344	47.970
M55 × 1.5	6g	0.032	54.968	54.732	53.994	53.834	0.160	53.344	52.910
M55 × 1.5	6h	0.000	55.000	54.764	54.026	53.866	0.160	53.376	52.942
M55 × 1.5	4g6g	0.032	54.968	54.732	53.994	53.894	0.100	53.344	52.970
M56 × 5.5	6g	0.075	55.925	55.365	52.353	52.088	0.265	49.971	48.700
M56 × 5.5	6h	0.000	56.000	55.440	52.428	52.163	0.265	50.046	48.775
M56 × 5.5	4g6g	0.075	55.925	55.365	52.353	52.183	0.170	49.971	48.795
M56 × 2	6g	0.038	55.962	55.682	54.663	54.483	0.180	53.797	53.251
M56 × 2	6h	0.000	56.000	55.720	54.701	54.521	0.180	53.835	53.289
M56 × 2	4g6g	0.038	55.962	55.682	54.663	54.551	0.112	53.797	53.319
M60 × 1.5	6g	0.032	59.968	59.732	58.994	58.834	0.160	58.344	57.910
M60 × 1.5	6h	0.000	60.000	59.764	59.026	58.866	0.160	58.376	57.942
M60 × 1.5	4g6g	0.032	59.968	59.732	58.994	58.894	0.100	58.344	57.970
M64 × 6	6g	0.080	63.920	63.320	60.023	59.743	0.280	57.425	56.047
M64 × 6	6h	0.000	64.000	63.400	60.103	59.823	0.280	57.505	56.127
M64 × 6	4g6g	0.080	63.920	63.320	60.023	59.843	0.180	57.425	56.147
M64 × 2	6g	0.038	63.962	63.682	62.663	62.483	0.180	61.797	61.251
M64 × 2	6h	0.000	64.000	63.720	62.701	62.521	0.180	61.835	61.289
M64 × 2	4g6g	0.038	63.962	63.682	62.663	62.551	0.112	61.797	61.319
M65 × 1.5	6g	0.032	64.968	64.732	63.994	63.834	0.160	63.344	62.910
M65 × 1.5	6h	0.000	65.000	64.764	64.026	63.866	0.160	63.376	62.942
M65 × 1.5	4g6g	0.032	64.968	64.732	63.994	63.894	0.100	63.344	62.970
M70 × 1.5	6g	0.032	69.968	69.732	68.994	68.834	0.160	68.344	67.910
M70 × 1.5	6h	0.000	70.000	69.764	69.026	68.866	0.160	68.376	67.942
M70 × 1.5	4g6g	0.032	69.968	69.732	68.994	68.894	0.100	68.344	67.970
M72 × 6	6g	0.080	71.920	71.320	68.023	67.743	0.280	65.425	64.047
M72 × 6	6h	0.000	72.000	71.400	68.103	67.823	0.280	65.505	64.127
M72 × 6	4g6g	0.080	71.920	71.320	68.023	67.843	0.180	65.425	64.147
M72 × 2	6g	0.038	71.962	71.682	70.663	70.483	0.180	69.797	69.251
M72 × 2	6h	0.000	72.000	71.720	70.701	70.521	0.180	69.835	69.289
M72 × 2	4g6g	0.038	71.962	71.682	70.663	70.551	0.112	69.797	69.319
M75 × 1.5	6g	0.032	74.968	74.732	73.994	73.834	0.160	73.344	72.910
M75 × 1.5	6h	0.000	75.000	74.764	74.026	73.866	0.160	73.376	72.942
M75 × 1.5	4g6g	0.032	74.968	74.732	73.994	73.894	0.100	73.344	72.970
M80 × 6	6g	0.080	79.920	79.320	76.023	75.743	0.280	73.425	72.047
M80 × 6	6h	0.000	80.000	79.400	76.103	75.823	0.280	73.505	72.127
M80 × 6	4g6g	0.080	79.920	79.320	76.023	75.843	0.180	73.425	72.147
M80 × 2	6g	0.038	79.962	79.682	78.663	78.483	0.180	77.797	77.251
M80 × 2	6h	0.000	80.000	79.720	78.701	78.521	0.180	77.835	77.289
M80 × 2	4g6g	0.038	79.962	79.682	78.663	78.551	0.112	77.797	77.319
M80 × 1.5	6g	0.032	79.968	79.732	78.994	78.834	0.160	78.344	77.910
M80 × 1.5	6h	0.000	80.000	79.764	79.026	78.866	0.160	78.376	77.942
M80 × 1.5	4g6g	0.032	79.968	79.732	78.994	78.894	0.100	78.344	77.970
M85 × 2	6g	0.038	84.962	84.682	83.663	83.483	0.180	82.797	82.251
M85 × 2	6h	0.000	85.000	84.720	83.701	83.521	0.180	82.835	82.289

Table 13. (Continued) External Metric Thread—M Profile Limiting Dimensions ANSI/ASME B1.13M-2005

Basic Thread Designation	Tol. Class	Allowance ^a <i>e_s</i>	Major Diameter ^b <i>d</i>		Pitch Diameter ^{b c} <i>d₂</i>			Minor Dia. ^b <i>d₁</i>	Minor Dia. ^d <i>d₃</i>
			Max.	Min.	Max.	Min.	Tol.	Max.	Min.
			M85 × 2	4g6g	0.038	84.962	84.682	83.663	83.551
M90 × 6	6g	0.080	89.920	89.320	86.023	85.743	0.280	83.425	82.047
M90 × 6	6h	0.000	90.000	89.400	86.103	85.823	0.280	83.505	82.127
M90 × 6	4g6g	0.080	89.920	89.320	86.023	85.843	0.180	83.425	82.147
M90 × 2	6g	0.038	89.962	89.682	88.663	88.483	0.180	87.797	87.251
M90 × 2	6h	0.000	90.000	89.720	88.701	88.521	0.180	87.835	87.289
M90 × 2	4g6g	0.038	89.962	89.682	88.663	88.551	0.112	87.797	87.319
M95 × 2	6g	0.038	94.962	94.682	93.663	93.473	0.190	92.797	92.241
M95 × 2	6h	0.000	95.000	94.720	93.701	93.511	0.190	92.835	92.279
M95 × 2	4g6g	0.038	94.962	94.682	93.663	93.545	0.118	92.797	92.313
M100 × 6	6g	0.080	99.920	99.320	96.023	95.723	0.300	93.425	92.027
M100 × 6	6h	0.000	100.000	99.400	96.103	95.803	0.300	93.505	92.107
M100 × 6	4g6g	0.080	99.920	99.320	96.023	95.833	0.190	93.425	92.137
M100 × 2	6g	0.038	99.962	99.682	98.663	98.473	0.190	97.797	97.241
M100 × 2	6h	0.000	100.000	99.720	98.701	98.511	0.190	97.835	97.279
M100 × 2	4g6g	0.038	99.962	99.682	98.663	98.545	0.118	97.797	97.313
M105 × 2	6g	0.038	104.962	104.682	103.663	103.473	0.190	102.797	102.241
M105 × 2	6h	0.000	105.000	104.720	103.701	103.511	0.190	102.835	102.279
M105 × 2	4g6g	0.038	104.962	104.682	103.663	103.545	0.118	102.797	102.313
M110 × 2	6g	0.038	109.962	109.682	108.663	108.473	0.190	107.797	107.241
M110 × 2	6h	0.000	110.000	109.720	108.701	108.511	0.190	107.835	107.279
M110 × 2	4g6g	0.038	109.962	109.682	108.663	108.545	0.118	107.797	107.313
M120 × 2	6g	0.038	119.962	119.682	118.663	118.473	0.190	117.797	117.241
M120 × 2	6h	0.000	120.000	119.720	118.701	118.511	0.190	117.835	117.279
M120 × 2	4g6g	0.038	119.962	119.682	118.663	118.545	0.118	117.797	117.313
M130 × 2	6g	0.038	129.962	129.682	128.663	128.473	0.190	127.797	127.241
M130 × 2	6h	0.000	130.000	129.720	128.701	128.511	0.190	127.835	127.279
M130 × 2	4g6g	0.038	129.962	129.682	128.663	128.545	0.118	127.797	127.313
M140 × 2	6g	0.038	139.962	139.682	138.663	138.473	0.190	137.797	137.241
M140 × 2	6h	0.000	140.000	139.720	138.701	138.511	0.190	137.835	137.279
M140 × 2	4g6g	0.038	139.962	139.682	138.663	138.545	0.118	137.797	137.313
M150 × 2	6g	0.038	149.962	149.682	148.663	148.473	0.190	147.797	147.241
M150 × 2	6h	0.000	150.000	149.720	148.701	148.511	0.190	147.835	147.279
M150 × 2	4g6g	0.038	149.962	149.682	148.663	148.545	0.118	147.797	147.313
M160 × 3	6g	0.048	159.952	159.577	158.003	157.779	0.224	156.704	155.931
M160 × 3	6h	0.000	160.000	159.625	158.051	157.827	0.224	156.752	155.979
M160 × 3	4g6g	0.048	159.952	159.577	158.003	157.863	0.140	156.704	156.015
M170 × 3	6g	0.048	169.952	169.577	168.003	167.779	0.224	166.704	165.931
M170 × 3	6h	0.000	170.000	169.625	168.051	167.827	0.224	166.752	165.979
M170 × 3	4g6g	0.048	169.952	169.577	168.003	167.863	0.140	166.704	166.015
M180 × 3	6g	0.048	179.952	179.577	178.003	177.779	0.224	176.704	175.931
M180 × 3	6h	0.000	180.000	179.625	178.051	177.827	0.224	176.752	175.979
M180 × 3	4g6g	0.048	179.952	179.577	178.003	177.863	0.140	176.704	176.015
M190 × 3	6g	0.048	189.952	189.577	188.003	187.753	0.250	186.704	185.905
M190 × 3	6h	0.000	190.000	189.625	188.051	187.801	0.250	186.752	185.953
M190 × 3	4g6g	0.048	189.952	189.577	188.003	187.843	0.160	186.704	185.995
M200 × 3	6g	0.048	199.952	199.577	198.003	197.753	0.250	196.704	195.905
M200 × 3	6h	0.000	200.000	199.625	198.051	197.801	0.250	196.752	195.953
M200 × 3	4g6g	0.048	199.952	199.577	198.003	197.843	0.160	196.704	195.995

^a *e_s* is an absolute value.

^b For coated threads with tolerance classes 6g or 4g6g, *Material Limits for Coated Threads*.

^c Functional diameter size includes the effects of all variations in pitch diameter, thread form, and profile. The variations in the individual thread characteristics such as flank angle, lead, taper, and roundness on a given thread, cause the measurements of the pitch diameter and functional diameter to vary from one another on most threads. The pitch diameter and the functional diameter on a given thread are equal to one another only when the thread form is perfect. When required to inspect either the pitch diameter, the functional diameter, or both, for thread acceptance, use the same limits of size for the appropriate thread size and class.

^d Dimension used in the design of tools, etc. in dimensioning external threads it is not normally specified. Generally, minor diameter acceptance is based on maximum material condition gaging.

All dimensions are in millimeters.

Metric Screw Thread Designations.—Metric screw threads are identified by the letter (M) for the thread form profile, followed by the nominal diameter size and the pitch expressed in millimeters, separated by the sign (×) and followed by the tolerance class separated by a dash (–) from the pitch.

The simplified international practice for designating coarse pitch M profile metric screw threads is to leave off the pitch. Thus a M14 × 2 thread is designated just M14. However, to prevent misunderstanding, it is mandatory to use the value for pitch in all designations.

Thread acceptability gaging system requirements of ANSI B1.3M may be added to the thread size designation as noted in the examples (numbers in parentheses) or as specified in pertinent documentation, such as the drawing or procurement document.

Unless otherwise specified in the designation, the screw thread is right hand.

Examples: External thread of M profile, right hand: M6 × 1 – 4g6g (22)

Internal thread of M profile, right hand: M6 × 1 – 5H6H (21)

Designation of Left Hand Thread: When a left hand thread is specified, the tolerance class designation is followed by a dash and LH.

Example: M6 × 1 – 5H6H – LH (23)

Designation for Identical Tolerance Classes: If the two tolerance class designations for a thread are identical, it is not necessary to repeat the symbols.

Example: M6 × 1 – 6H (21)

Designation Using All Capital Letters: When computer and teletype thread designations use all capital letters, the external or internal thread may need further identification. Thus the tolerance class is followed by the abbreviations EXT or INT in capital letters.

Examples: M6 × 1 – 4G6G EXT; M6 × 1 – 6H INT

Designation for Thread Fit: A fit between mating threads is indicated by the internal thread tolerance class followed by the external thread tolerance class and separated by a slash.

Examples: M6 × 1 – 6H/6g; M6 × 1 – 6H/4g6g

Designation for Rounded Root External Thread: The M profile with a minimum root radius of 0.125P on the external thread is desirable for all threads but is mandatory for threaded mechanical fasteners of ISO 898/I property class 8.8 (minimum tensile strength 800 MPa) and stronger. No special designation is required for these threads. Other parts requiring a 0.125P root radius must have that radius specified.

When a special rounded root is required, its external thread designation is suffixed by the minimum root radius value in millimeters and the letter R.

Example: M42 × 4.5 – 6g – 0.63R

Designation of Threads Having Modified Crests: Where the limits of size of the major diameter of an external thread or the minor diameter of an internal thread are modified, the thread designation is suffixed by the letters MOD followed by the modified diameter limits.

Examples:

External thread M profile, major diameter reduced 0.075 mm. M6 × 1 – 4h6h MOD Major dia = 5.745 – 5.925 MOD	Internal thread M profile, minor diameter increased 0.075 mm. M6 × 1 – 4H5H MOD Minor dia = 5.101 – 5.291 MOD
-------------------------------------------------------------------------------------------------------------------	---------------------------------------------------------------------------------------------------------------------

Designation of Special Threads: Special diameter-pitch threads developed in accordance with this Standard ANSI/ASME B1.13M are identified by the letters SPL following the tolerance class. The limits of size for the major diameter, pitch diameter, and minor diameter are specified below this designation.

Examples:

External thread	Internal thread
M6.5 × 1 – 4h6h – SPL (22)	M6.5 × 1 – 4H5H – SPL (23)
Major dia = 6.320 – 6.500	Major dia = 6.500 min
Pitch dia = 5.779 – 5.850	Pitch dia = 5.850 – 5.945
Minor dia = 5.163 – 5.386	Minor dia = 5.417 – 5.607

Designation of Multiple Start Threads: When a thread is required with a multiple start, it is designated by specifying sequentially: M for metric thread, nominal diameter size, × L for lead, lead value, dash, P for pitch, pitch value, dash, tolerance class, parenthesis, script number of starts, and the word starts, close parenthesis.

Examples: M16 × L4 – P2 – 4h6h (TWO STARTS)
 M14 × L6 – P2 – 6H (THREE STARTS)

Designation of Coated or Plated Threads: In designating coated or plated M threads the tolerance class should be specified as after coating or after plating. If no designation of after coating or after plating is specified, the tolerance class applies before coating or plating in accordance with ISO practice. After plating, the thread must not transgress the maximum material limits for the tolerance position H/h.

Examples: M6 × 1 – 6h AFTER COATING or AFTER PLATING
 M6 × 1 – 6g AFTER COATING or AFTER PLATING

Where the tolerance position G/g is insufficient relief for the application to hold the threads within product limits, the coating or plating allowance may be specified as the maximum and minimum limits of size for minor and pitch diameters of internal threads or major and pitch diameters for external threads before coating or plating.

Example: Allowance on external thread M profile based on 0.010 mm minimum coating thickness.

M6 × 1 – 4h6h – AFTER COATING
 BEFORE COATING
 Major dia = 5.780 – 5.940
 Pitch dia = 5.239 – 5.290

Metric Screw Threads—MJ Profile

The MJ screw thread is intended for aerospace metric threaded parts and for other highly stressed applications requiring high temperature or high fatigue strength, or for “no allowance” applications. The MJ profile thread is a hard metric version similar to the UNJ inch standards, ANSI/ASME B1.15 and MIL-S-8879. The MJ profile thread has a 0.15011P to 0.180424P controlled root radius in the external thread and the internal thread minor diameter truncated to accommodate the external thread maximum root radius.

First issued in 1978, the American National Standard ANSI/ASME B1.21M-1997 establishes the basic triangular profile for the MJ form of thread; gives a system of designations; lists the standard series of diameter-pitch combinations for diameters from 1.6 to 200 mm; and specifies limiting dimensions and tolerances. Changes included in the 1997 revision are the addition of tolerance class 4G6G and 4G5G/4g6g comparable to ANSI/ASME B1.15 (UNJ thread); the addition of tolerance class 6H/6g comparable to ANSI/ASME B1.13M; and changes in the rounding procedure as set forth in ANSI/ASME B1.30M.

Diameter-Pitch Combinations.—This Standard includes a selected series of diameter-pitch combinations of threads taken from International Standard ISO 261 plus some additional sizes in the constant pitch series. These are given in [Table 1](#). It also includes the standard series of diameter-pitch combinations for aerospace screws, bolts, nuts, and fluid system fittings as shown in [Table 2](#).

**Table 1. ANSI Standard Metric Screw Threads MJ Profile
Diameter-Pitch Combinations ANSI/ASME B1.21M-1997 (R2003)**

Nominal Diameter		Pitches		Nominal Diameter		Pitches	
Choices		Coarse	Fine	Choices		Coarse	Fine
1st	2nd			1st	2nd		
1.6	...	0.35	52	...	3, 2, 1.5
...	1.8	0.35	...	55	3, 2, 1.5
2.0	...	0.4	56	5.5	3, 2, 1.5
...	2.2	0.45	58	...	3, 2, 1.5
2.5	...	0.45	...	60	3, 2, 1.5
3	...	0.5	62	...	3, 2, 1.5
3.5	...	0.6	64	6	3, 2, 1.5
4	...	0.7	...	65	3, 2, 1.5
...	4.5	0.75	68	...	3, 2, 1.5
5	...	0.8	...	70	3, 2, 1.5
6	...	1	0.75	...	72	6	3, 2, 1.5
7	...	1	0.75	75	3, 2, 1.5
8	...	1.25	1, 0.75	...	76	...	3, 2, 1.5
...	9	1.25	1, 0.75	...	78	...	3 ^a , 2, 1.5 ^a
10	...	1.5	1.25, 1, 0.75	80	...	6	3, 2, 1.5
...	11	1.5	1.25 ^b , 1, 0.75	...	82	...	3 ^a , 2, 1.5 ^a
12	...	1.75	1.5, 1.25, 1	85	3, 2, 1.5 ^a
14	...	2	1.5, 1.25 ^c , 1	90	...	6	3, 2, 1.5 ^a
...	15	...	1.5, 1	95	3, 2, 1.5 ^a
16	...	2	1.5, 1	100	...	6	3, 2, 1.5 ^a
...	17	...	1.5, 1	105	3, 2, 1.5 ^a
18	...	2.5	2, 1.5, 1	110	3, 2, 1.5 ^a
20	...	2.5	2, 1.5, 1	...	115	...	3, 2, 1.5 ^a
22	...	2.5	2, 1.5, 1	120	3, 2, 1.5 ^a
24	...	3	2, 1.5, 1	...	125	...	3, 2, 1.5 ^a
...	25	...	2, 1.5, 1	130	3, 2, 1.5 ^a
...	26	...	1.5	...	135	...	3, 2, 1.5 ^a
27	...	3	2, 1.5, 1	140	3, 2, 1.5 ^a
...	28	...	2, 1.5, 1	...	145	...	3, 2, 1.5 ^a
30	...	3.5	3, 2, 1.5, 1	150	3, 2, 1.5 ^a
...	32	...	2, 1.5	...	155	...	3
33	3, 2, 1.5	160	3
...	35	...	1.5	...	165	...	3
36	...	4	3, 2, 1.5	170	3
...	38	...	1.5	...	175	...	3
39	3, 2, 1.5	180	3
...	40	...	3, 2, 1.5	...	185	...	3
.	42	4.5	3, 2, 1.5	190	3
45	3, 2, 1.5	...	195	...	3
...	48	5	3, 2, 1.5	200	3
50	3, 2, 1.5

^aNot included in ISO 261.

^bOnly for aircraft control cable fittings.

^cOnly for spark plugs for engines.

All dimensions are in millimeters. Pitches in parentheses () are to be avoided as far as possible.

Table 2. ANSI Standard Metric Screw Threads MJ Profile, Diameter-Pitch Combinations for Aerospace ANSI/ASME B1.21M-1997 (R2003)

Aerospace Screws, Bolts and Nuts								Aerospace Fluid System Fittings					
Nom. Size ^a	Pitch	Nom. Size	Pitch	Nom. Size	Pitch	Nom. Size	Pitch	Nom. Size	Pitch	Nom. Size	Pitch	Nom. Size	Pitch
1.6	0.35	5	0.8	14	1.5	27	2	8	1	20	1.5	36	1.5
2	0.4	6	1	16	1.5	30	2	10	1	22	1.5	39	1.5
2.5	0.45	7	1	18	1.5	33	2	12	1.25	24	1.5	42	2
3	0.5	8	1	20	1.5	36	2	14	1.5	27	1.5	48	2
3.5	0.6	10	1.25	22	1.5	39	2	16	1.5	30	1.5	50	2
4	0.7	12	1.25	24	2	18	1.5	33	1.5

All dimensions are in millimeters.

^aFor threads smaller than 1.6 mm nominal size, use miniature screw threads (ANSI B1.10M).

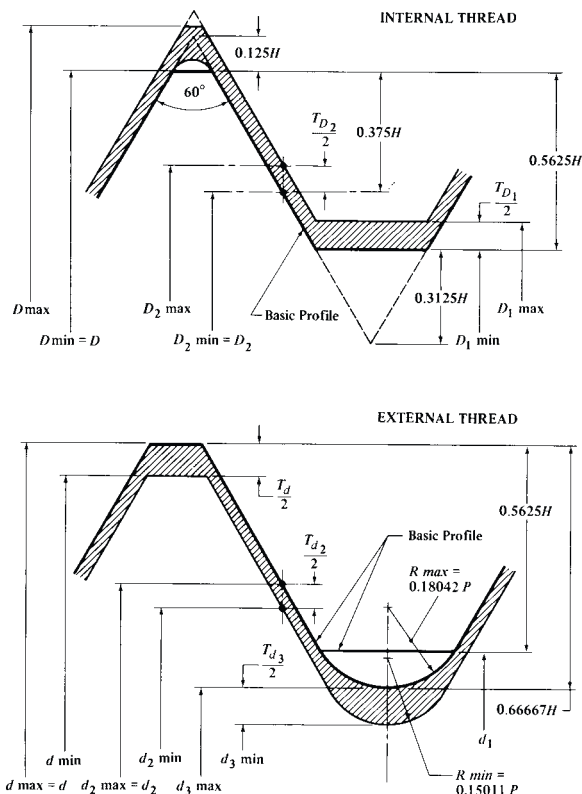

Fig. 1. Internal MJ Thread Basic and Design Profiles (Top) and External MJ Thread Basic and Design Profiles (Bottom) Showing Tolerance Zones

Tolerances: The thread tolerance system is based on ISO 965/1, *Metric Screw thread System of Tolerance Positions and Grades*. Tolerances are positive for internal threads and negative for external threads, that is, in the direction of minimum material.

For aerospace applications, except for fluid fittings, tolerance classes 4H5H or 4G6G and 4g6g should be used. These classes approximate classes 3B/3A in the inch system. Aerospace fluid fittings use classes 4H5H or 4H6H and 4g6g.

Tolerance classes 4G5G or 4G6G and 4g6g are provided for use when thread allowances are required. These classes provide a slightly tighter fit than the inch classes 2B/2A at minimum material condition.

Additional tolerance classes 6H/6g are included in this Standard to provide appropriate product selection based on general applications. These classes and the selection of standard diameter/pitch combinations are the same as those provided for the M profile metric screw threads in ANSI/ASME B1.13M. Classes 6H/6g result in a slightly looser fit than inch classes 2B/2A at minimum material condition.

Symbols: Standard symbols appearing in Fig. 1 are:

D = Basic major diameter of internal thread

D_2 = Basic pitch diameter of internal thread

D_1 = Basic minor diameter of internal thread

d = Basic major diameter of external thread

d_2 = Basic pitch diameter of external thread

d_1 = Basic minor diameter of internal thread

d_3 = Diameter to bottom of external thread root radius

H = Height of fundamental triangle

P = Pitch

Basic Designations: The aerospace metric screw thread is designated by the letters "MJ" to identify the metric J thread form, followed by the nominal size and pitch in millimeters (separated by the sign "×") and followed by the tolerance class (separated by a dash from the pitch). Unless otherwise specified in the designation, the thread helix is right hand.

Example: MJ6 × 1 – 4h6h

For further details concerning limiting dimensions, allowances for coating and plating, modified and special threads, etc., reference should be made to the Standard.

Trapezoidal Metric Thread

Comparison of ISO and DIN Standards.—ISO metric trapezoidal screw threads standard, ISO 2904-1977, describes the system of general purpose metric threads for use in mechanisms and structures. The standard is in basic agreement with trapezoidal metric thread DIN 103. The DIN 103 standard applies a particular pitch for a particular diameter of thread, but the ISO standard applies a variety of pitches for a particular diameter. In ISO 2904-1977, the same clearance is applied to both the major diameter and minor diameter, but in DIN 103 the clearance in the minor diameter is two or three times greater than clearance in the major diameter. A comparison of DIN 103 is given in Table 1.

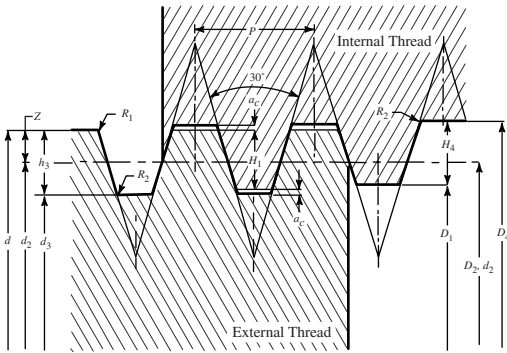

Metric Trapezoidal Thread, ISO 2904

Terminology: The term "bolt threads" is used for external screw threads, the term "nut threads" for internal screw threads.

Calculation: The value given in the International standards have been calculated by using the following formulas:

$$\begin{aligned}
 H_1 &= 0.5P & H_4 &= H_1 + a_c = 0.5P + a_c & H_3 &= H_1 + a_c = 0.5P + a_c \\
 D_4 &= d + 2a_c & Z &= 0.25P = H_1/2 & D_1 &= d - 2H_1 = d - p \\
 D_3 &= D - 2h_3 & d_2 &= D_2 = d - 2Z = d - 0.5P & R_{1\max.} &= 0.5a_c & R_{2\max.} &= a_c
 \end{aligned}$$

where a_c = clearance on the crest; D = major diameter for nut threads; D_2 = pitch diameter for nut threads; D_1 = minor diameter for nut threads; d = major diameter for bolt threads = nominal diameter; d_2 = pitch diameter for bolt threads; d_3 = minor diameter for bolt threads; h_1 = Height of overlapping; h_4 = height of nut threads; h_3 = height of bolt threads; and, P = pitch.

Table 1. Comparison of ISO Metric Trapezoidal Screw Thread ISO 2904-1977 and Trapezoidal Metric Screw Thread DIN 103

	ISO 2904	DIN 103	Comment
Nominal Diameter	D	D_5	
Pitch	p	p	Same
Clearances (Bolt Circle)	a_c	b	Same
Clearances (Nut Circle)	a_c	a	Not same
Height of Overlapping	h_1	h_e	Same
Bolt Circle			
	$h_3 = 0.50P + a_c$	$h_s = 0.50P + a$	Same
	$h_{as} = 0.25p$	$z = 0.25p$	Same
Minor diameter for external thread	$D_3 = d - 2h_3$	$k_s = d - 2h_s$	Same
Pitch diameter for external thread	$D_2 = d - 2h_{as}$	$d_2 = d - 2z$	Same
Nut Circle			
Basic major diameter for nut thread	$D_4 = d + 2a_c$	$d_n = d + a + b$	Not same
Height of internal thread	$h_4 = h_3$	$h_n = h_3 + a$	Not same
Minor diameter of internal thread	$D_1 = D - 2h_1$	$K_n = D_n - 2h_n$	Not same

Table 2. ISO Metric Trapezoidal Screw Thread ISO 2904-1977

Nominal Diameter, d			Pitch, P	Pitch Diam. $d_2 = D_2$	Major Diam. D_4	Minor Diameter	
						d_3	D_1
8			1.5	7.250	8.300	6.200	6.500
			2	8.250	9.300	7.200	7.500
	9		1.5	8.000	9.500	6.500	7.000
			2	9.250	10.300	8.200	8.500
10			1.5	9.000	10.500	7.500	8.000
			2	10.000	11.500	8.500	9.000
	11		2	9.500	11.500	7.500	8.000
			3	11.000	12.500	9.500	10.000
12			2	10.500	12.500	8.500	9.000
			3	13.000	14.500	11.500	12.000
	14		2	12.500	14.500	10.500	11.000
			3	15.000	16.500	13.500	14.000
16			2	14.500	16.500	12.500	13.000
			3	17.000	18.500	15.500	16.000
	18		2	16.000	18.500	13.500	14.000
			4	19.000	20.500	17.500	18.000
20			2	18.000	20.500	15.500	16.000
			4	20.500	22.500	18.500	19.000
	22		3	19.500	22.500	16.500	17.000
			5	18.000	23.000	13.000	14.000
			8	22.500	24.500	20.500	21.000
			3	21.500	24.500	18.500	19.000
24			5	20.000	25.000	15.000	16.000
			8	24.500	26.500	22.500	23.000
	26		3	23.500	26.500	20.500	21.000
			5	22.000	27.000	17.000	18.000
			8	26.500	28.500	24.500	25.000
			3	25.500	28.500	22.500	23.000
28			5	24.000	29.000	19.000	20.000
			8	28.500	30.500	26.500	27.000
	30		3	27.000	31.000	23.000	24.000
			6	25.000	31.000	19.000	20.000
			10	30.500	32.500	28.500	29.000
			3	29.000	33.000	25.000	26.000
32			6	27.000	33.000	21.000	22.000
			10	32.500	34.500	30.500	31.000
	34		3	31.000	35.000	27.000	28.000
			6	29.000	35.000	23.000	24.000
			10	34.500	36.500	32.500	33.000
			3	33.000	37.000	29.000	30.000
36			6	31.000	37.000	25.000	26.000
			10	36.500	38.500	34.500	35.000
	38		3	34.500	39.000	30.000	31.000
			7	33.000	39.000	27.000	28.000
			10	38.500	40.500	36.500	37.000
			3	36.500	41.000	32.000	33.000
40			7	35.000	41.000	29.000	30.000
			10	38.500	41.000	36.500	37.000

Table 2. (Continued) ISO Metric Trapezoidal Screw Thread ISO 2904-1977

Nominal Diameter, d			Pitch, P	Pitch Diam. $d_2 = D_2$	Major Diam. D_4	Minor Diameter	
						d_3	D_1
42			3	40.500	42.500	38.500	39.000
			7	38.500	43.000	34.000	35.000
			10	37.000	43.000	31.000	32.000
44			3	42.500	44.500	40.500	41.000
			7	40.500	45.000	36.000	37.000
			12	38.000	45.000	31.000	32.000
46			3	44.500	46.500	42.500	43.000
			8	42.000	47.000	37.000	38.000
			12	40.000	47.000	33.000	34.000
48			3	46.500	48.500	44.500	45.000
			8	44.000	49.000	39.000	40.000
			12	42.000	49.000	35.000	36.000
50			3	48.500	50.500	46.500	47.000
			8	46.000	51.000	41.000	42.000
			12	44.000	51.000	37.000	38.000
52			3	50.500	52.500	48.500	49.000
			8	48.000	53.000	43.000	44.000
			12	46.000	53.000	39.000	40.000
55			3	53.500	55.500	51.500	52.000
			9	50.500	56.000	45.000	46.000
			14	48.000	57.000	39.000	41.000
60			3	58.500	60.500	56.500	57.000
			9	55.500	61.000	50.000	51.000
			14	53.000	62.000	44.000	46.000
65			4	63.000	65.500	60.500	61.000
			10	60.000	66.000	54.000	55.000
			16	57.000	67.000	47.000	49.000
70			4	68.000	70.500	65.500	66.000
			10	65.000	71.000	59.000	60.000
			16	62.000	72.000	52.000	54.000
75			4	73.000	75.500	70.500	71.000
			10	70.000	76.000	64.000	65.000
			16	67.000	77.000	57.000	59.000
80			4	78.000	80.500	75.500	76.000
			10	75.000	81.000	69.000	70.000
			16	72.000	82.000	62.000	64.000
85			4	83.000	85.500	80.500	81.000
			12	79.000	86.000	72.000	73.000
			18	76.000	87.000	65.000	67.000
90			4	88.000	90.500	85.500	86.000
			12	84.000	91.000	77.000	78.000
			18	81.000	92.000	70.000	72.000
95			4	93.000	95.500	90.500	91.000
			12	89.000	96.000	82.000	83.000
95			18	86.000	97.000	75.000	77.000
			4	98.000	100.500	95.500	96.000
100			12	94.000	101.000	87.000	88.000
			20	90.000	102.000	78.000	80.000

Table 2. (Continued) ISO Metric Trapezoidal Screw Thread ISO 2904-1977

Nominal Diameter, d			Pitch, P	Pitch Diam. $d_2 = D_2$	Major Diam. D_4	Minor Diameter	
						d_3	D_1
105			4	103.000	105.500	100.500	101.000
			12	103.000	106.000	92.000	93.000
			20	95.000	107.000	83.000	85.000
110			4	108.000	110.500	105.500	106.000
			12	104.000	111.000	97.000	98.000
			20	100.000	112.000	88.000	90.000
115			6	112.000	116.000	108.000	109.000
			14	112.000	117.000	99.000	101.000
			22	104.000	117.000	91.000	93.000
120			6	117.000	121.000	113.000	114.000
			14	113.000	122.000	104.000	106.000
			22	109.000	122.000	96.000	98.000
125			6	122.000	126.000	118.000	119.000
			14	122.000	127.000	109.000	111.000
			22	114.000	127.000	101.000	103.000
130			6	127.000	131.000	123.000	124.000
			14	123.000	132.000	114.000	116.000
			22	119.000	132.000	106.000	108.000
135			6	132.000	136.000	128.000	129.000
			14	132.000	137.000	119.000	121.000
			24	123.000	137.000	109.000	111.000
140			6	137.000	141.000	133.000	134.000
			14	133.000	142.000	124.000	126.000
			24	128.000	142.000	114.000	116.000
145			6	142.000	146.000	138.000	139.000
			14	142.000	147.000	129.000	131.000
			24	133.000	147.000	119.000	121.000
150			6	147.000	151.000	143.000	144.000
			16	142.000	152.000	132.000	134.000
			24	138.000	152.000	124.000	126.000
155			6	152.000	156.000	148.000	149.000
			16	152.000	157.000	137.000	139.000
			24	143.000	157.000	129.000	131.000
160			6	157.000	161.000	153.000	154.000
			16	152.000	162.000	142.000	144.000
			28	146.000	162.000	130.000	132.000
165			6	162.000	166.000	158.000	159.000
			16	162.000	167.000	147.000	149.000
			28	151.000	167.000	135.000	137.000
170			6	167.000	171.000	163.000	164.000
			16	162.000	172.000	152.000	154.000
			28	156.000	172.000	140.000	142.000
175			8	171.000	176.000	166.000	167.000
			16	171.000	177.000	157.000	159.000
			28	161.000	177.000	145.000	147.000
180			8	176.000	181.000	171.000	172.000
			18	171.000	182.000	160.000	162.000
			28	166.000	182.000	150.000	152.000

Table 2. (Continued) ISO Metric Trapezoidal Screw Thread ISO 2904-1977

Nominal Diameter, d			Pitch, P	Pitch Diam. $d_2 = D_2$	Major Diam. D_4	Minor Diameter	
						d_3	D_1
185			8	181.000	186.000	176.000	177.000
			18	181.000	187.000	165.000	167.000
			32	169.000	187.000	151.000	153.000
190			8	186.000	191.000	181.000	182.000
			18	181.000	192.000	170.000	172.000
			32	174.000	192.000	156.000	158.000
195			8	191.000	196.000	186.000	187.000
			18	191.000	197.000	175.000	177.000
			32	179.000	197.000	161.000	163.000
200			8	196.000	201.000	191.000	192.000
			18	191.000	202.000	180.000	182.000
			32	184.000	202.000	166.000	168.000
210			8	206.000	211.000	201.000	202.000
			20	200.000	212.000	188.000	190.000
			36	192.000	212.000	172.000	174.000
220			8	216.000	221.000	211.000	212.000
			20	210.000	222.000	198.000	200.000
			36	202.000	222.000	182.000	184.000
230			8	226.000	231.000	221.000	222.000
			20	220.000	232.000	208.000	210.000
			36	212.000	232.000	192.000	194.000
240			8	236.000	241.000	231.000	232.000
			22	229.000	242.000	216.000	218.000
			36	222.000	242.000	202.000	204.000
250			12	244.000	251.000	237.000	238.000
			22	239.000	252.000	226.000	228.000
			40	230.000	252.000	208.000	210.000
260			12	254.000	261.000	247.000	248.000
			22	249.000	262.000	236.000	238.000
			40	240.000	262.000	218.000	220.000
270			12	264.000	271.000	257.000	258.000
			24	258.000	272.000	244.000	246.000
			40	250.000	272.000	228.000	230.000
280			12	274.000	281.000	267.000	268.000
			24	268.000	282.000	254.000	256.000
			40	260.000	282.000	238.000	240.000
290			12	284.000	291.000	277.000	278.000
			24	278.000	292.000	264.000	266.000
			44	268.000	292.000	244.000	246.000
300			12	294.000	301.000	287.000	288.000
			24	288.000	302.000	274.000	276.000
			44	278.000	302.000	254.000	256.000

All dimensions in millimeters

Trapezoidal Metric Thread — Preferred Basic Sizes DIN 103

$$H = 1.866P$$

$$h_e = 0.5P + a$$

$$h_s = 0.5P + a - b$$

$$h_n = 0.5P + 2a - b$$

$$h_{as} = 0.25P$$

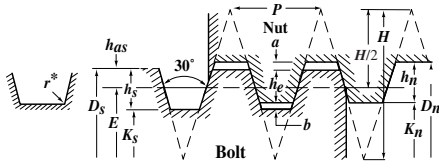

Nom. & Major Diam. of Bolt, D_s	Pitch, P	Pitch Diam., E	Depth of Engagement, h_e	Clearance		Bolt		Nut		
				a	b	Minor Diam., K_s	Depth of Thread, h_s	Major Diam., D_n	Minor Diam., K_n	Depth of Thread, h_n
10	3	8.5	1.25	0.25	0.5	6.5	1.75	10.5	7.5	1.50
12	3	10.5	1.25	0.25	0.5	8.5	1.75	12.5	9.5	1.50
14	4	12	1.75	0.25	0.5	9.5	2.25	14.5	10.5	2.00
16	4	14	1.75	0.25	0.5	11.5	2.25	16.5	12.5	2.00
18	4	16	1.75	0.25	0.5	13.5	2.25	18.5	14.5	2.00
20	4	18	1.75	0.25	0.5	15.5	2.25	20.5	16.5	2.00
22	5	19.5	2	0.25	0.75	16.5	2.75	22.5	18	2.00
24	5	21.5	2	0.25	0.75	18.5	2.75	24.5	20	2.25
26	5	23.5	2	0.25	0.75	20.5	2.75	26.5	22	2.25
28	5	25.5	2	0.25	0.75	22.5	2.75	28.5	24	2.25
30	6	27	2.5	0.25	0.75	23.5	3.25	30.5	25	2.75
32	6	29	2.5	0.25	0.75	25.5	3.25	32.5	27	2.75
36	6	33	2.5	0.25	0.75	29.5	3.25	36.5	31	2.75
40	7	36.5	3	0.25	0.75	32.5	3.75	40.5	34	3.25
44	7	40.5	3	0.25	0.75	36.5	3.75	44.5	38	3.25
48	8	44	3.5	0.25	0.75	39.5	4.25	48.5	41	3.75
50	8	46	3.5	0.25	0.75	41.5	4.25	50.5	43	3.75
52	8	48	3.5	0.25	0.75	43.5	4.25	52.5	45	3.75
55	9	50.5	4	0.25	0.75	45.5	4.75	55.5	47	4.25
60	9	55.5	4	0.25	0.75	50.5	4.75	60.5	52	4.25
65	10	60	4.5	0.25	0.75	54.5	5.25	65.5	56	4.75
70	10	65	4.5	0.25	0.75	59.5	5.25	70.5	61	4.75
75	10	70	4.5	0.25	0.75	64.5	5.25	75.5	66	4.75
80	10	75	4.5	0.25	0.75	69.5	5.25	80.5	71	4.75
85	12	79	5.5	0.25	0.75	72.5	6.25	85.5	74	5.75
90	12	84	5.5	0.25	0.75	77.5	6.25	90.5	79	5.75
95	12	89	5.5	0.25	0.75	82.5	6.25	95.5	84	5.75
100	12	94	5.5	0.25	0.75	87.5	6.25	100.5	89	5.75
110	12	104	5.5	0.25	0.75	97.5	6.25	110.5	99	5.75
120	14	113	6	0.5	1.5	105	7.5	121	108	6.5
130	14	123	6	0.5	1.5	115	7.5	131	118	6.5
140	14	133	6	0.5	1.5	125	7.5	141	128	6.5
150	16	142	7	0.5	1.5	133	8.5	151	136	7.5
160	16	152	7	0.5	1.5	143	8.5	161	146	7.5
170	16	162	7	0.5	1.5	153	8.5	171	156	7.5
180	18	171	8	0.5	1.5	161	9.5	181	164	8.5
190	18	181	8	0.5	1.5	171	9.5	191	174	8.5
200	18	191	8	0.5	1.5	181	9.5	201	184	8.5
210	20	200	9	0.5	1.5	189	10.5	211	192	9.5
220	20	210	9	0.5	1.5	199	10.5	221	202	9.5
230	20	220	9	0.5	1.5	209	10.5	231	212	9.5
240	22	229	10	0.5	1.5	217	11.5	241	220	10.5
250	22	239	10	0.5	1.5	227	11.5	251	230	10.5
260	22	249	10	0.5	1.5	237	11.5	261	240	10.5
270	24	258	11	0.5	1.5	245	12.5	271	248	11.5
280	24	268	11	0.5	1.5	255	12.5	281	258	11.5
290	24	278	11	0.5	1.5	265	12.5	291	268	11.5
300	26	287	12	0.5	1.5	273	13.5	301	276	12.5

All dimensions are in millimeters.

*Roots are rounded to a radius, r , equal to 0.25 mm for pitches of from 3 to 12 mm inclusive and 0.5 mm for pitches of from 14 to 26 mm inclusive for power transmission.

ISO Miniature Screw Threads

ISO Miniature Screw Threads, Basic Form ISO/R 1501:1970

Pitch <i>P</i>	$H = 0.866025P$	$0.554256H = 0.48P$	$0.375H = 0.324760P$	$0.320744H = 0.320744P$	$0.125H = 0.108253P$
0.08	0.069282	0.038400	0.025981	0.022222	0.008660
0.09	0.077942	0.043200	0.029228	0.024999	0.009743
0.1	0.086603	0.048000	0.032476	0.027777	0.010825
0.125	0.108253	0.060000	0.040595	0.034722	0.013532
0.15	0.129904	0.072000	0.048714	0.041666	0.016238
0.175	0.151554	0.084000	0.056833	0.048610	0.018944
0.2	0.173205	0.096000	0.064952	0.055554	0.021651
0.225	0.194856	0.108000	0.073071	0.062499	0.024357
0.25	0.216506	0.120000	0.081190	0.069443	0.027063
0.3	0.259808	0.144000	0.097428	0.083332	0.032476

ISO Miniature Screw Threads, Basic Dimensions ISO/R 1501:1970

Nominal Diameter	Pitch <i>P</i>	Major Diameter <i>D</i> , <i>d</i>	Pitch Diameter <i>D</i> ₂ , <i>d</i> ₂	Minor Diameter <i>D</i> ₁ , <i>d</i> ₁
0.30	0.080	0.300000	0.248039	0.223200
0.35	0.090	0.350000	0.291543	0.263600
0.40	0.100	0.400000	0.335048	0.304000
0.45	0.100	0.450000	0.385048	0.354000
0.50	0.125	0.500000	0.418810	0.380000
0.55	0.125	0.550000	0.468810	0.430000
0.60	0.150	0.600000	0.502572	0.456000
0.70	0.175	0.700000	0.586334	0.532000
0.80	0.200	0.800000	0.670096	0.608000
0.90	0.225	0.900000	0.753858	0.684000
1.00	0.250	1.000000	0.837620	0.760000
1.10	0.250	1.100000	0.937620	0.860000
1.20	0.250	1.200000	1.037620	0.960000
1.40	0.300	1.400000	1.205144	1.112000

D and *d* dimensions refer to the nut (internal) and screw (external) threads, respectively.

British Standard ISO Metric Screw Threads

BS 3643:Part 1:1981 (R2004) provides principles and basic data for ISO metric screw threads. It covers single-start, parallel screw threads of from 1 to 300 millimeters in diameter. Part 2 of the Standard gives the specifications for selected limits of size.

Basic Profile.—The ISO basic profile for triangular screw threads is shown in Fig. 1. and basic dimensions of this profile are given in Table 1.

Table 1. British Standard ISO Metric Screw Threads
 Basic Profile Dimensions BS 3643:1981 (R2004)

Pitch <i>P</i>	$H = 0.86603P$	$\frac{5}{8}H = 0.54127P$	$\frac{3}{8}H = 0.32476P$	$H/4 = 0.21651P$	$H/8 = 0.10825P$
0.2	0.173 205	0.108 253	0.064 952	0.043 301	0.021 651
0.25	0.216 506	0.135 316	0.081 190	0.054 127	0.027 063
0.3	0.259 808	0.162 380	0.097 428	0.064 952	0.032 476
0.35	0.303 109	0.189 443	0.113 666	0.075 777	0.037 889
0.4	0.346 410	0.216 506	0.129 904	0.086 603	0.043 301
0.45	0.389 711	0.243 570	0.146 142	0.097 428	0.048 714
0.5	0.433 013	0.270 633	0.162 380	0.108 253	0.054 127
0.6	0.519 615	0.324 760	0.194 856	0.129 904	0.064 952
0.7	0.606 218	0.378 886	0.227 322	0.151 554	0.075 777

Table 1. (Continued) British Standard ISO Metric Screw Threads Basic Profile Dimensions BS 3643:1981 (R2004)

Pitch <i>P</i>	<i>H</i> = 0.086603 <i>P</i>	$\frac{5}{8}H$ = 0.54127 <i>P</i>	$\frac{3}{8}H$ = 0.32476 <i>P</i>	<i>H</i> /4 = 0.21651 <i>P</i>	<i>H</i> /8 = 0.10825 <i>P</i>
0.75	0.649 519	0.405 949	0.243 570	0.162 380	0.081 190
0.8	0.692 820	0.433 013	0.259 808	0.173 205	0.086 603
1	0.866 025	0.541 266	0.324 760	0.216 506	0.108 253
1.25	1.082 532	0.676 582	0.405 949	0.270 633	0.135 316
1.5	1.299 038	0.811 899	0.487 139	0.324 760	0.162 380
1.75	1.515 544	0.947 215	0.568 329	0.378 886	0.189 443
2	1.732 051	1.082 532	0.649 519	0.433 013	0.216 506
2.5	2.165 063	1.353 165	0.811 899	0.541 266	0.270 633
3	2.598 076	1.623 798	0.974 279	0.649 519	0.324 760
3.5	3.031 089	1.894 431	1.136 658	0.757 772	0.378 886
4	3.464 102	2.165 063	1.299 038	0.866 025	0.433 013
4.5	3.897 114	2.435 696	1.461 418	0.974 279	0.487 139
5	4.330 127	2.706 329	1.623 798	1.082 532	0.541 266
5.5	4.763 140	2.976 962	1.786 177	1.190 785	0.595 392
6	5.196 152	3.247 595	1.948 557	1.299 038	0.649 519
8 ^a	6.928 203	4.330 127	2.598 076	1.732 051	0.866 025

^aThis pitch is not used in any of the ISO metric standard series.
All dimensions are given in millimeters.

Tolerance System.—The tolerance system defines *tolerance classes* in terms of a combination of a *tolerance grade* (figure) and a *tolerance position* (letter). The tolerance position is defined by the distance between the basic size and the nearest end of the tolerance zone, this distance being known as the *fundamental deviation*, EI, in the case of internal threads, and es in the case of external threads. These tolerance positions with respect to the basic size (zero line) are shown in Fig. 2 and fundamental deviations for nut and bolt threads are given in Table 2.

Table 2. Fundamental Deviations for Nut Threads and Bolt Threads

Pitch <i>P</i> mm	Nut Thread <i>D</i> ₂ , <i>D</i> ₁		Bolt Thread <i>d</i> , <i>d</i> ₂				Pitch <i>P</i> mm	Nut Thread <i>D</i> ₂ , <i>D</i> ₁		Bolt Thread <i>d</i> , <i>d</i> ₂			
	Tolerance Position							Tolerance Position					
	G	H	e	f	g	h		G	H	e	f	g	h
	Fundamental Deviation							Fundamental Deviation					
	EI	EI	es	es	es	es		EI	EI	es	es	es	es
μm	μm	μm	μm	μm	μm	μm	μm	μm	μm	μm	μm		
0.2	+17	0	-17	0	1.25	+28	0	-63	-42	-28	0
0.25	+18	0	-18	0	1.5	+32	0	-67	-45	-32	0
0.3	+18	0	-18	0	1.75	+34	0	-71	-48	-34	0
0.35	+19	0	...	-34	-19	0	2	+38	0	-71	-52	-38	0
0.4	+19	0	...	-34	-19	0	2.5	+42	0	-80	-58	-42	0
0.45	+20	0	...	-35	-20	0	3	+48	0	-85	-63	-48	0
0.5	+20	0	-50	-36	-20	0	3.5	+53	0	-90	-70	-53	0
0.6	+21	0	-53	-36	-21	0	4	+60	0	-95	-75	-60	0
0.7	+22	0	-56	-38	-22	0	4.5	+63	0	-100	-80	-63	0
0.75	+22	0	-56	-38	-22	0	5	+71	0	-106	-85	-71	0
0.8	+24	0	-60	-38	-24	0	5.5	+75	0	-112	-90	-75	0
1	+26	0	-60	-40	-26	0	6	+80	0	-118	-95	-80	0

See Figs. 1 and 2 for meaning of symbols.

Tolerance Grades.—Tolerance grades specified in the Standard for each of the four main screw thread diameters are as follows:

Minor diameter of nut threads (D_1): tolerance grades 4, 5, 6, 7, and 8.

Major diameter of bolt threads (d): tolerance grades 4, 6, and 8.

Pitch diameter of nut threads (D_2): tolerance grades 4, 5, 6, 7, and 8.

Pitch diameter of bolt threads (d_2): tolerance grades 3, 4, 5, 6, 7, 8, and 9.

Tolerance Positions.—Tolerance positions are G and H for nut threads and e, f, g, and h for bolt threads. The relationship of these tolerance position identifying letters to the amount of fundamental deviation is shown in Table 2.

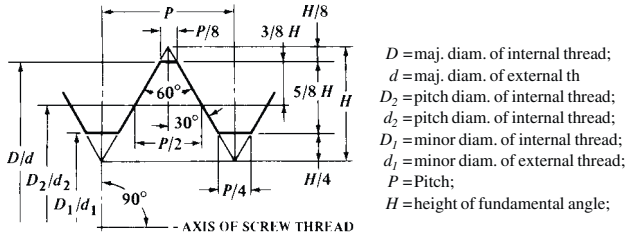

Fig. 1. Basic Profile of ISO Metric Thread

Tolerance Classes.—To reduce the number of gages and tools, the Standard specifies that the tolerance positions and classes shall be chosen from those listed in Table 3 for short, normal, and long lengths of thread engagement. The following rules apply for the choice of tolerance quality: *Fine*: for precision threads when little variation of fit character is needed; *Medium*: for general use; and *Coarse*: for cases where manufacturing difficulties can arise as, for example, when threading hot-rolled bars and long blind holes. If the actual length of thread engagement is unknown, as in the manufacturing of standard bolts, normal is recommended.

Table 3. Tolerance Classes^{a,b,c} for Nuts and Bolts

Tolerance Classes for Nuts												
Tolerance Quality	Tolerance Position G			Tolerance Position H								
	Short	Normal	Long	Short	Normal	Long						
Fine	4H ^b	5H ^b	6H ^b						
Medium	5G ^a	6G ^c	7G ^c	5H ^a	6H ^{a,d}	7H ^a						
Coarse	...	7G ^c	8G ^c	...	7H ^b	8H ^b						
Tolerance Classes for Bolts												
Tolerance Quality	Tolerance Position e			Tolerance Position f			Tolerance Position g			Tolerance Position h		
	Short	Normal	Long	Short	Normal	Long	Short	Normal	Long	Short	Normal	Long
Fine	3h4h ^c	4h ^a	5h4h ^c
Medium	...	6e ^a	7e6e ^c	...	6f ^a	...	5g6g ^c	6g ^{a,d}	7g6g ^c	5h6h ^c	6h ^b	7h6h ^c
Coarse	8g ^b	9g8g ^c

^a First choice.

^b Second choice.

^c Third choice; these are to be avoided.

^d For commercial nut and bolt threads.

Note: See Table 4 for short, normal, and long categories. Any of the recommended tolerance classes for nuts can be combined with any of the recommended tolerance classes for bolts with the exception of sizes M1.4 and smaller for which the combination 5H/6h or finer shall be chosen. However, to guarantee a sufficient overlap, the finished components should preferably be made to form the fits H/g, H/h, or G/h.

Table 4. Lengths of Thread Engagements for Short, Normal, and Long Categories

Basic Major Diameter d		Pitch P	Length of Thread Engagement			Basic Major Diameter d		Pitch P	Length of Thread Engagement		
Over	Up to and Incl.		Short	Normal	Long	Over	Up to and Incl.		Short	Normal	Long
			Up to and Incl.	Over	Up to and Incl.				Over	Up to and Incl.	Over
0.99	1.4	0.2	0.5	0.5	1.4	22.4	45	1	4	4	12
		0.25	0.6	0.6	1.7			1.5	6.3	6.3	19
		0.3	0.7	0.7	2			2	8.5	8.5	25
1.4	2.8	0.2	0.5	0.5	1.5	45	90	3	12	12	36
		0.25	0.6	0.6	1.9			3.5	15	15	45
		0.35	0.8	0.8	2.6			4	18	18	53
		0.4	1	1	3			4.5	21	21	63
		0.45	1.3	1.3	3.8			5	24	24	71
2.8	5.6	0.35	1	1	3	90	180	1.5	7.5	7.5	22
		0.5	1.5	1.5	4.5			2	9.5	9.5	28
		0.6	1.7	1.7	5			3	15	15	45
		0.7	2	2	6			4	19	19	56
		0.75	2.2	2.2	6.7			5	24	24	71
		0.8	2.5	2.5	7.5			5.5	28	28	85
5.6	11.2	0.75	2.4	2.4	7.1	180	300	6	32	32	95
		1	3	3	9			2	12	12	36
		1.25	4	4	12			3	18	18	53
		1.5	5	5	15			4	24	24	71
11.2	22.4	1	3.8	3.8	11	300	450	6	36	36	106
		1.25	4.5	4.5	13			3	20	20	60
		1.5	5.6	5.6	16			4	26	26	80
		1.75	6	6	18			6	40	40	118
		2	8	8	24						
		2.5	10	10	30						

All dimensions are given in millimeters

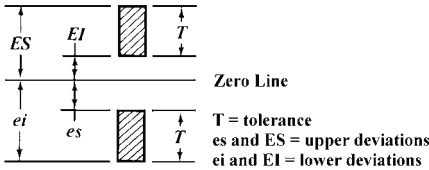

Fig. 2. Tolerance Positions with Respect to Zero Line (Basic Size)

Design Profiles.—The design profiles for ISO metric internal and external screw threads are shown in Fig. 3. These represent the profiles of the threads at their maximum metal condition. It may be noted that the root of each thread is deepened so as to clear the basic flat crest of the other thread. The contact between the thread is thus confined to their sloping flanks. However, for nut threads as well as bolt threads, the actual root contours shall not at any point violate the basic profile.

Designation.—Screw threads complying with the requirements of the Standard shall be designated by the letter M followed by values of the nominal diameter and of the pitch, expressed in millimeters, and separated by the sign \times . *Example:* M6 \times 0.75. The absence of the indication of pitch means that a coarse pitch is specified.

The complete designation of a screw thread consists of a designation for the thread system and size, and a designation for the crest diameter tolerance. Each class designation consists of: a figure indicating the tolerance grade; and a letter indicating the tolerance

position, capital for nuts, lower case for bolts. If the two class designations for a thread are the same (one for the pitch diameter and one for the crest diameter), it is not necessary to repeat the symbols. As examples, a bolt thread designated M10-6g signifies a thread of 10 mm nominal diameter in the Coarse Thread Series having a tolerance class 6g for both pitch and major diameters. A designation M10 × 1-5g6g signifies a bolt thread of 10 mm nominal diameter having a pitch of 1 mm, a tolerance class 5g for pitch diameter, and a tolerance class 6g for major diameter. A designation M10-6H signifies a nut thread of 10 mm diameter in the Coarse Thread Series having a tolerance class 6H for both pitch and minor diameters.

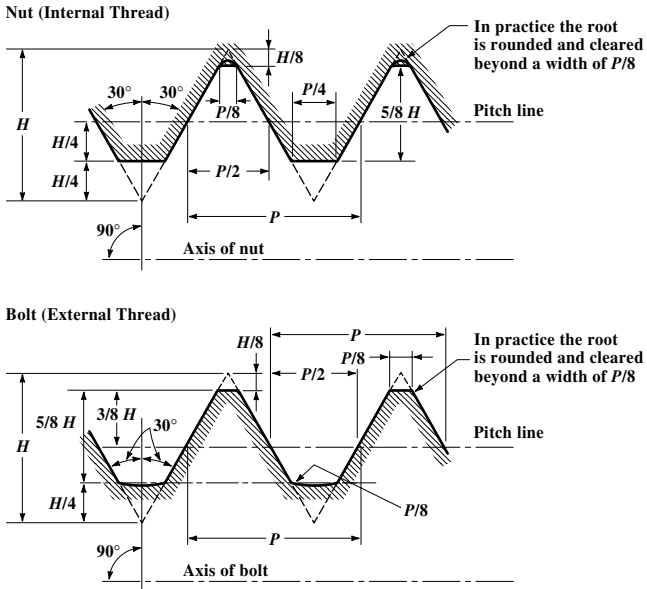

Fig. 3. Maximum Material Profiles for Internal and External Threads

A fit between mating parts is indicated by the nut thread tolerance class followed by the bolt thread tolerance class separated by an oblique stroke. *Examples:* M6-6H/6g and M20 × 2-6H/5g6g. For coated threads, the tolerances apply to the parts before coating, unless otherwise specified. After coating, the actual thread profile shall not at any point exceed the maximum material limits for either tolerance position H or h.

Fundamental Deviation Formulas.—The formulas used to calculate the fundamental deviations in Table 2 are:

$$EI_G = +(15 + 11P)$$

$$EI_H = 0$$

$$es_e = -(50 + 11P) \text{ except for threads with } P \leq 0.45 \text{ mm}$$

$$es_f = -(30 + 11P)$$

$$es_g = -(15 + 11P)$$

$$es_h = 0$$

In these formulas, EI and es are expressed in micrometers and P is in millimeters.

Crest Diameter Tolerance Formulas.—The tolerances for the major diameter of bolt threads (T_d), grade 6, in Table 5, were calculated from the formula:

$$T_d(6) = 180 \sqrt[3]{P^2} - \frac{3.15}{\sqrt{P}}$$

In this formula, $T_d(6)$ is in micrometers and P is in millimeters. For tolerance grades 4 and 8: $T_d(4) = 0.63 T_d(6)$ and $T_d(8) = 1.6 T_d(6)$, respectively.

The tolerances for the minor diameter of nut threads (T_{D1}), grade 6, in Table 5, were calculated as follows:

For pitches 0.2 to 0.8 mm, $T_{D1}(6) = 433P - 190P^{1.22}$.

For pitches 1 mm and coarser, $T_{D1}(6) = 230P^{0.7}$.

In these formulas, $T_{D1}(6)$ is in micrometers and P is in millimeters. For tolerance grades 4, 5, 7, and 8: $T_{D1}(4) = 0.63 T_{D1}(6)$; $T_{D1}(5) = 0.8 T_{D1}(6)$; $T_{D1}(7) = 1.25 T_{D1}(6)$; and $T_{D1}(8) = 1.6 T_{D1}(6)$, respectively.

Table 5. British Standard ISO Metric Screw Threads: Limits and Tolerances for Finished Uncoated Threads for Normal Lengths of Engagement BS 3643: Part 2: 1981

Nominal Diameter ^a	Pitch		External Threads (Bolts)						Internal Threads (Nuts) ^b							
	Course	Fine	Tol. Class	Fund. dev.	Major Dia.		Pitch Dia.		Minor Dia	Tol. Class	Major Dia.		Pitch Dia.		Minor Dia	
					Max	Tol(-)	Max	Tol(-)	Min		Min	Max	Tol(-)	Max	Tol(-)	
1	0.25	0.2	4h	0	1.000	0.036	0.870	0.030	0.717	4H	1.000	0.910	0.040	0.821	0.038	
			6g	0.017	0.983	0.056	0.853	0.048	0.682							
	0.25	0.2	4h	0	1.000	0.042	0.838	0.034	0.649	4H	1.000	0.883	0.045	0.774	0.045	
			6g	0.018	0.982	0.067	0.820	0.053	0.613	5H	1.000	0.894	0.056	0.785	0.056	
	1.1	0.25	0.2	4h	0	1.100	0.036	0.970	0.030	0.817	4H	1.100	1.010	0.040	0.921	0.038
				6g	0.017	1.083	0.056	0.953	0.048	0.782						
1.1	0.25	0.25	4h	0	1.100	0.042	0.938	0.034	0.750	4H	1.100	0.983	0.045	0.874	0.045	
			6g	0.018	1.082	0.067	0.920	0.053	0.713	5H	1.100	0.994	0.056	0.885	0.056	
1.2	0.25	0.2	4h	0	1.200	0.036	1.070	0.030	0.917	4H	1.200	1.110	0.040	1.021	0.038	
			6g	0.017	1.183	0.056	1.053	0.048	0.882							
1.2	0.25	0.25	4h	0	1.200	0.042	1.038	0.034	0.850	4H	1.200	1.083	0.045	0.974	0.045	
			6g	0.018	1.182	0.067	1.020	0.053	0.813	5H	1.200	1.094	0.056	0.985	0.056	
1.4	0.3	0.2	4h	0	1.400	0.036	1.270	0.030	1.117	4H	1.400	1.310	0.040	1.221	0.038	
			6g	0.017	1.383	0.056	1.253	0.048	1.082							
1.4	0.3	0.3	4h	0	1.400	0.048	1.205	0.036	0.984	4H	1.400	1.253	0.048	1.128	0.053	
			6g	0.018	1.382	0.075	1.187	0.056	0.946	5H	1.400	1.265	0.060	1.142	0.067	
1.6	0.35	0.2	4h	0	1.600	0.036	1.470	0.032	1.315	4H	1.600	1.512	0.042	1.421	0.038	
			6g	0.017	1.583	0.056	1.453	0.050	1.280							
1.6	0.35	0.35	4h	0	1.600	0.053	1.373	0.040	1.117	4H	1.600	1.426	0.053	1.284	0.063	
			6g	0.019	1.581	0.085	1.354	0.063	1.075	5H	1.600	1.440	0.067	1.301	0.080	
1.8	0.35	0.2	4h	0	1.800	0.036	1.670	0.032	1.515	4H	1.800	1.712	0.042	1.621	0.038	
			6g	0.017	1.783	0.056	1.653	0.050	1.480							
1.8	0.35	0.35	4h	0	1.800	0.053	1.573	0.040	1.317	4H	1.800	1.626	0.053	1.484	0.063	
			6g	0.019	1.781	0.085	1.554	0.063	1.275	5H	1.800	1.640	0.067	1.501	0.080	
2	0.4	0.25	4h	0	2.000	0.042	1.838	0.036	1.648	4H	2.000	1.886	0.048	1.774	0.045	
			6g	0.018	1.982	0.067	1.820	0.056	1.610	5H	2.000	1.898	0.060	1.785	0.056	
2	0.4	0.4	4h	0	2.000	0.060	1.740	0.042	1.452	4H	2.000	1.796	0.056	1.638	0.071	
			6g	0.019	1.981	0.095	1.721	0.067	1.408	5H	2.000	1.811	0.071	1.657	0.090	
2.2	0.45	0.25	4h	0	2.200	0.042	2.038	0.036	1.848	4H	2.200	2.086	0.048	1.974	0.045	
			6g	0.018	2.182	0.067	2.020	0.056	1.810	5H	2.200	2.098	0.060	1.985	0.056	
2.2	0.45	0.45	4h	0	2.200	0.063	1.908	0.045	1.585	4H	2.200	1.968	0.060	1.793	0.080	
			6g	0.020	2.180	0.100	1.888	0.071	1.539	5H	2.200	1.983	0.075	1.813	0.100	
									6H	2.000	2.003	0.095	1.838	0.125		

Table 5. (Continued) British Standard ISO Metric Screw Threads: Limits and Tolerances for Finished Uncoated Threads for Normal Lengths of Engagement BS 3643: Part 2: 1981

Nominal Diameter ^a	Pitch		External Threads (Bolts)						Internal Threads (Nuts) ^b							
	Coarse	Fine	Tol. Class	Fund. dev.	Major Dia.		Pitch Dia.		Minor Dia	Tol. Class	Major Dia.		Pitch Dia.		Minor Dia	
					Max	Tol(-)	Max	Tol(-)			Min	Min	Max	Tol(-)	Max	Tol(-)
2.5	0.35	4h 6g	0 0.019	2.500	0.053	2.273	0.040	2.017	4H	2.500	2.326	0.053	2.184	0.063		
				2.481	0.085	2.254	0.063	1.975	5H	2.500	2.340	0.067	2.201	0.080		
									6H	2.500	2.358	0.085	2.221	0.100		
	0.45	4h 6g	0 0.020	2.500	0.063	2.208	0.045	1.885	4H	2.500	2.268	0.060	2.093	0.080		
				2.480	0.100	2.188	0.071	1.839	5H	2.500	2.283	0.075	2.113	0.100		
									6H	2.500	2.303	0.095	2.138	0.125		
3	0.35	4h 6g	0 0.019	3.000	0.053	2.773	0.042	2.515	4H	3.000	2.829	0.056	2.684	0.063		
				2.981	0.085	2.754	0.067	2.471	5H	3.000	2.844	0.071	2.701	0.080		
									6H	3.000	2.863	0.090	2.721	0.100		
	0.5	4h 6g	0 0.020	3.000	0.067	2.675	0.048	2.319	5H	3.000	2.755	0.080	2.571	0.112		
				2.980	0.106	2.655	0.075	2.272	6H	3.000	2.775	0.100	2.599	0.140		
									7H	3.000	2.800	0.125	2.639	0.180		
3.5	0.35	4h 6g	0 0.019	3.500	0.053	3.273	0.042	3.015	4H	3.500	3.329	0.056	3.184	0.063		
				3.481	0.085	3.254	0.067	2.971	5H	3.500	3.344	0.071	3.201	0.080		
									6H	3.500	3.363	0.090	3.221	0.100		
	0.6	4h 6g	0 0.021	3.500	0.080	3.110	0.053	2.688	5H	3.500	3.200	0.090	2.975	0.125		
				3.479	0.125	3.089	0.085	2.635	6H	3.500	3.222	0.112	3.010	0.160		
									7H	3.500	3.250	0.140	3.050	0.200		
4	0.5	4h 6g	0 0.020	4.000	0.067	3.675	0.048	3.319	5H	4.000	3.755	0.080	3.571	0.112		
				3.980	0.106	3.655	0.075	3.272	6H	4.000	3.775	0.100	3.599	0.140		
									7H	4.000	3.800	0.125	3.639	0.180		
	0.7	4h 6g	0 0.022	4.000	0.090	3.545	0.056	3.058	5H	4.000	3.640	0.095	3.382	0.140		
				3.978	0.140	3.523	0.090	3.002	6H	4.000	3.663	0.118	3.422	0.180		
									7H	4.000	3.695	0.150	3.466	0.224		
4.5	0.5	4h 6g	0 0.020	4.500	0.067	4.175	0.048	3.819	5H	4.500	4.255	0.080	4.071	0.112		
				4.480	0.106	4.155	0.075	3.772	6H	4.500	4.275	0.100	4.099	0.140		
									7H	4.500	4.300	0.125	4.139	0.180		
	0.75	4h 6g	0 0.022	4.500	0.090	4.013	0.056	3.495	5H	4.500	4.108	0.095	3.838	0.150		
				4.478	0.140	3.991	0.090	3.439	6H	4.500	4.131	0.118	3.878	0.190		
									7H	4.500	4.163	0.150	3.924	0.236		
5	0.5	4h 6g	0 0.020	5.000	0.067	4.675	0.048	4.319	5H	5.000	4.755	0.080	4.571	0.112		
				4.980	0.106	4.655	0.075	4.272	6H	5.000	4.775	0.100	4.599	0.140		
									7H	5.000	4.800	0.125	4.639	0.180		
	0.8	4h 6g	0 0.024	5.000	0.095	4.480	0.060	3.927	5H	5.000	4.580	0.100	4.294	0.160		
				4.976	0.150	4.456	0.095	3.868	6H	5.000	4.605	0.125	4.334	0.200		
									7H	5.000	4.640	0.160	4.384	0.250		
5.5	0.5	4h 6g	0 0.020	5.500	0.067	5.175	0.048	4.819	5H	5.500	5.255	0.080	5.071	0.112		
				5.480	0.106	5.155	0.075	4.772	6H	5.500	5.275	0.100	5.099	0.140		
									7H	5.500	5.300	0.125	5.139	0.180		
	0.75	4h 6g	0 0.022	6.000	0.090	5.513	0.063	4.988	5H	6.000	5.619	0.106	5.338	0.150		
				5.978	0.140	5.491	0.100	4.929	6H	6.000	5.645	0.132	5.378	0.190		
									7H	6.000	5.683	0.170	5.424	0.236		
6	1	4h 6g	0 0.026	6.000	0.112	5.350	0.071	4.663	5H	6.000	5.468	0.118	5.107	0.190		
				5.974	0.180	5.324	0.112	4.597	6H	6.000	5.500	0.150	5.153	0.236		
				5.974	0.280	5.324	0.180	4.528	7H	6.000	5.540	0.190	5.217	0.300		
	0.75	4h 6g	0 0.022	7.000	0.090	6.513	0.063	5.988	5H	7.000	6.619	0.106	6.338	0.150		
				6.978	0.140	6.491	0.100	5.929	6H	7.000	6.645	0.132	6.378	0.190		
									7H	7.000	6.683	0.170	6.424	0.236		
7	1	4h 6g	0 0.026	7.000	0.112	6.350	0.071	5.663	5H	7.000	6.468	0.118	6.107	0.190		
				6.974	0.180	6.324	0.112	5.596	6H	7.000	6.500	0.150	6.153	0.236		
				6.974	0.280	6.324	0.180	5.528	7H	7.000	6.540	0.190	6.217	0.300		
	1.25	4h 6g	0 0.028	8.000	0.132	7.188	0.075	6.343	5H	8.000	7.313	0.125	6.859	0.212		
				7.972	0.212	7.160	0.118	6.272	6H	8.000	7.348	0.160	6.912	0.265		
				7.972	0.335	7.160	0.190	6.200	7H	8.000	7.388	0.200	6.982	0.335		

Table 5. (Continued) British Standard ISO Metric Screw Threads: Limits and Tolerances for Finished Uncoated Threads for Normal Lengths of Engagement BS 3643: Part 2: 1981

Nominal Diameter ^a	Pitch		External Threads (Bolts)						Internal Threads (Nuts) ^b							
	Coarse	Fine	Tol. Class	Fund dev.	Major Dia.		Pitch Dia.		Minor Dia	Tol. Class	Major Dia.		Pitch Dia.		Minor Dia	
					Max	Tol(-)	Max	Tol(-)	Min		Min	Max	Tol(-)	Max	Tol(-)	
9	1.25	4h	0	9.000	0.132	8.188	0.075	7.343	5H	9.000	8.313	0.125	7.859	0.212		
6g		0.028	8.972	0.212	8.160	0.008	7.272	6H	9.000	8.348	0.160	7.912	0.265			
8g		0.028	8.972	0.335	8.160	0.190	7.200	7H	9.000	8.388	0.200	7.982	0.335			
10	1.25	4h	0	10.000	0.132	9.188	0.075	8.343	5H	10.000	9.313	0.125	8.859	0.212		
		6g	0.028	9.972	0.212	9.160	0.118	8.272	6H	10.000	9.348	0.160	8.912	0.265		
		8g	0.028	9.972	0.335	9.160	0.190	8.200	7H	10.000	9.388	0.200	8.982	0.335		
	1.5	4h	0	10.000	0.150	9.026	0.085	8.018	5H	10.000	9.166	0.140	8.612	0.236		
		6g	0.032	9.968	0.236	8.994	0.132	7.938	6H	10.000	9.206	0.180	8.676	0.300		
		8g	0.032	9.968	0.375	8.994	0.212	7.858	7H	10.000	9.250	0.224	8.751	0.375		
11	1.5	4h	0	11.000	0.150	10.026	0.085	9.018	5H	11.000	10.166	0.140	9.612	0.236		
		6g	0.032	10.968	0.236	9.994	0.132	8.938	6H	11.000	10.206	0.180	9.676	0.300		
		8g	0.032	10.968	0.375	9.994	0.212	8.858	7H	11.000	10.250	0.224	9.751	0.375		
12	1.25	4h	0	12.000	0.132	11.188	0.085	10.333	5H	12.000	11.328	0.140	10.859	0.212		
		6g	0.028	11.972	0.212	11.160	0.132	10.257	6H	12.000	11.398	0.180	10.912	0.265		
		8g	0.028	11.972	0.335	11.160	0.212	10.177	7H	12.000	11.412	0.224	10.985	0.335		
	1.75	4h	0	12.000	0.170	10.863	0.095	9.692	5H	12.000	11.023	0.160	10.371	0.265		
		6g	0.034	11.966	0.265	10.829	0.150	9.602	6H	12.000	11.063	0.200	10.441	0.335		
		8g	0.034	11.966	0.425	10.829	0.236	9.516	7H	12.000	11.113	0.250	10.531	0.425		
14	1.5	4h	0	14.000	0.150	13.026	0.090	12.012	5H	14.000	13.176	0.150	12.612	0.236		
		6g	0.032	13.968	0.236	12.994	0.140	11.930	6H	14.000	13.216	0.190	12.676	0.300		
		8g	0.032	13.968	0.375	12.994	0.224	11.846	7H	14.000	13.262	0.226	12.751	0.375		
	2	4h	0	14.000	0.180	12.701	0.100	11.369	5H	14.000	12.871	0.170	12.135	0.300		
		6g	0.038	13.962	0.280	12.663	0.160	11.271	6H	14.000	12.913	0.212	12.210	0.375		
		8g	0.038	13.962	0.450	12.663	0.250	11.181	7H	14.000	12.966	0.265	12.310	0.475		
16	1.5	4h	0	16.000	0.150	15.026	0.090	14.012	5H	16.000	15.176	0.150	14.612	0.236		
		6g	0.032	15.968	0.236	14.994	0.140	13.930	6H	16.000	15.216	0.190	14.676	0.300		
		8g	0.032	15.968	0.375	14.994	0.224	13.846	7H	16.000	15.262	0.236	14.751	0.375		
	2	4h	0	16.000	0.180	14.701	0.100	13.369	5H	16.000	14.871	0.170	14.135	0.300		
		6g	0.038	15.962	0.280	14.663	0.160	13.271	6H	16.000	14.913	0.212	14.210	0.375		
		8g	0.038	15.962	0.450	14.663	0.250	13.181	7H	16.000	14.966	0.265	14.310	0.475		
18	1.5	4h	0	18.000	0.150	17.026	0.090	16.012	5H	18.000	17.176	0.150	16.612	0.236		
		6g	0.032	17.968	0.236	16.994	0.140	15.930	6H	18.000	17.216	0.190	16.676	0.300		
		8g	0.032	17.968	0.375	16.994	0.224	15.846	7H	18.000	17.262	0.236	16.751	0.375		
	2.5	4h	0	18.000	0.212	16.376	0.106	14.730	5H	18.000	16.556	0.180	15.649	0.355		
		6g	0.042	17.958	0.335	16.334	0.170	14.624	6H	18.000	16.600	0.224	15.774	0.450		
		8g	0.042	17.958	0.530	16.334	0.265	14.529	7H	18.000	16.656	0.280	15.854	0.560		
20	1.5	4h	0	20.000	0.150	19.026	0.090	18.012	5H	20.000	19.176	0.150	18.612	0.236		
		6g	0.032	19.968	0.236	18.994	0.140	17.930	6H	20.000	0.190	19.190	18.676	0.300		
		8g	0.032	19.968	0.375	18.994	0.224	17.846	7H	20.000	19.262	0.236	18.751	0.375		
	2.5	4h	0	20.000	0.212	18.376	0.106	16.730	5H	20.000	18.556	0.180	17.649	0.355		
		6g	0.042	19.958	0.335	18.334	0.170	16.624	6H	20.000	18.600	0.224	17.744	0.450		
		8g	0.042	19.958	0.530	18.334	0.265	16.529	7H	20.000	18.650	0.280	17.854	0.560		
22	1.5	4h	0	22.000	0.150	21.026	0.090	20.012	5H	22.000	21.176	0.150	20.612	0.236		
		6g	0.032	21.968	0.236	20.994	0.140	19.930	6H	22.000	21.216	0.190	20.676	0.300		
		8g	0.032	21.968	0.375	20.994	0.224	19.846	7H	22.000	21.262	0.236	20.751	0.375		
	2.5	4h	0	22.000	0.212	20.376	0.106	18.730	5H	22.000	20.556	0.180	19.649	0.355		
		6g	0.042	21.958	0.335	20.334	0.170	18.624	6H	22.000	20.600	0.224	19.744	0.450		
		8g	0.042	21.958	0.530	20.334	0.265	18.529	7H	22.000	20.656	0.280	19.854	0.560		
24	2	4h	0	24.000	0.180	22.701	0.106	21.363	5H	24.000	22.881	0.180	22.135	0.300		
		6g	0.038	23.962	0.280	22.663	0.170	21.261	6H	24.000	22.925	0.224	22.210	0.375		
		8g	0.038	23.962	0.450	22.663	0.265	21.166	7H	24.000	22.981	0.280	22.310	0.475		
	3	4h	0	24.000	0.236	22.051	0.125	20.078	5H	24.000	22.263	0.212	21.152	0.400		
		6g	0.048	23.952	0.375	22.003	0.200	19.955	6H	24.000	22.316	0.265	21.252	0.500		
		8g	0.048	23.952	0.600	22.003	0.315	19.840	7H	24.000	22.386	0.335	21.382	0.630		
27	2	4h	0	27.000	0.180	25.701	0.106	24.363	5H	27.000	25.881	0.180	25.135	0.300		
		6g	0.038	26.962	0.280	25.663	0.170	24.261	6H	27.000	25.925	0.224	25.210	0.375		
		8g	0.038	26.962	0.450	25.663	0.265	24.166	7H	27.000	25.981	0.280	25.310	0.475		
	3	4h	0	27.000	0.236	25.051	0.125	23.078	5H	27.000	25.263	0.212	24.152	0.400		
		6g	0.048	26.952	0.375	25.003	0.200	22.955	6H	27.000	25.316	0.265	24.252	0.500		
		8g	0.048	26.952	0.600	25.003	0.315	22.840	7H	27.000	25.386	0.335	24.382	0.630		

Table 5. (Continued) British Standard ISO Metric Screw Threads: Limits and Tolerances for Finished Uncoated Threads for Normal Lengths of Engagement BS 3643: Part 2: 1981

Nominal Diameter ^a	Pitch		External Threads (Bolts)							Internal Threads (Nuts) ^b						
	Coarse	Fine	Tol. Class	Fund. dev.	Major Dia.		Pitch Dia.		Minor Dia	Tol. Class	Major Dia.		Pitch Dia.		Minor Dia	
					Max	Tol(-)	Max	Tol(-)	Min		Min	Max	Tol(-)	Max	Tol(-)	
					4h	6g	8g	5H	6H		7H	5H	6H	7H	5H	6H
30	2	4h	0	30.000	0.180	28.701	0.106	27.363	5H	30.000	28.881	0.180	28.135	0.300		
			0.038	29.962	0.280	28.663	0.170	27.261	6H	30.000	27.925	0.224	28.210	0.375		
			0.038	29.962	0.450	28.663	0.265	27.166	7H	30.000	28.981	0.280	28.310	0.475		
	3.5	4h	0	30.000	0.265	27.727	0.132	25.439	5H	30.000	27.951	0.224	26.661	0.450		
			0.053	29.947	0.425	27.674	0.212	25.305	6H	30.000	28.007	0.280	26.771	0.560		
			0.053	29.947	0.670	27.674	0.335	25.183	7H	30.000	28.082	0.355	26.921	0.710		
33	2	4h	0	33.000	0.180	31.701	0.106	30.363	5H	33.000	31.881	0.180	31.135	0.300		
			0.038	32.962	0.280	31.663	0.170	30.261	6H	33.000	31.925	0.224	31.210	0.375		
			0.038	32.962	0.450	30.663	0.265	30.166	7H	33.000	31.981	0.280	31.310	0.475		
	3.5	4h	0	33.000	0.265	30.727	0.132	28.438	5H	33.000	30.951	0.224	29.661	0.450		
			0.053	32.947	0.425	30.674	0.212	28.305	6H	33.000	31.007	0.280	29.771	0.560		
			0.053	32.947	0.670	30.674	0.335	28.182	7H	33.000	31.082	0.355	29.921	0.710		
36	4	4h	0	36.000	0.300	33.402	0.140	30.798	5H	36.000	33.638	0.236	32.145	0.475		
			0.060	35.940	0.475	33.342	0.224	30.654	6H	36.000	33.702	0.300	32.270	0.600		
			0.060	35.940	0.750	33.342	0.355	30.523	7H	36.000	33.777	0.375	32.420	0.750		
39	4	4h	0	39.000	0.300	36.402	0.140	33.798	5H	39.000	36.638	0.236	35.145	0.475		
			0.060	38.940	0.475	36.342	0.224	33.654	6H	39.000	36.702	0.300	35.270	0.600		
			0.060	38.940	0.750	36.342	0.355	33.523	7H	39.000	36.777	0.375	35.420	0.750		

^a This table provides coarse- and fine-pitch series data for threads listed in Table 6 for first, second, and third choices. For constant-pitch series and for larger sizes than are shown, refer to the Standard.

^b The fundamental deviation for internal threads (nuts) is zero for threads in this table.

All dimensions are in millimeters.

Diameter/Pitch Combinations.—Part 1 of BS 3643 provides a choice of diameter/pitch combinations shown here in Table 6. The use of first-choice items is preferred but if necessary, second, then third choice combinations may be selected. If pitches finer than those given in Table 6 are necessary, only the following pitches should be used: 3, 2, 1.5, 1, 0.75, 0.5, 0.35, 0.25, and 0.2 mm. When selecting such pitches it should be noted that there is increasing difficulty in meeting tolerance requirements as the diameter is increased for a given pitch. It is suggested that diameters greater than the following should not be used with the pitches indicated:

Pitch, mm	0.5	0.75	1	1.5	2	3
Maximum Diameter, mm	22	33	80	150	200	300

In cases where it is necessary to use a thread with a pitch larger than 6 mm, in the diameter range of 150 to 300 mm, the 8 mm pitch should be used.

Limits and Tolerances for Finished Uncoated Threads.—Part 2 of BS 3643 specifies the fundamental deviations, tolerances, and limits of size for the tolerance classes 4H, 5H, 6H, and 7H for internal threads (nuts) and 4h, 6g, and 8g for external threads (bolts) for coarse-pitch series within the range of 1 to 68 mm; fine-pitch series within the range of 1 to 33 mm; and constant pitch series within the range of 8 to 300 mm diameter.

The data in Table 5 provide the first, second, and third choice combinations shown in Table 6 except that constant-pitch series threads are omitted. For diameters larger than shown in Table 5, and for constant-pitch series data, refer to the Standard.

**Table 6. British Standard ISO Metric Screw Threads—
Diameter/Pitch Combinations BS 3643:Part 1:1981 (R2004)**

Nominal Diameter			Coarse Pitch	Fine Pitch	Constant Pitch	Nominal Diameter			Constant Pitch
Choices						Choices			
1st	2nd	3rd				1st	2nd	3rd	
1	0.25	0.2	70	6, 4, 3, 2, 1.5
...	1.1	...	0.25	0.2	...	72	6, 4, 3, 2, 1.5
1.2	0.25	0.2	75	4, 3, 2, 1.5
...	1.4	...	0.3	0.2	76	...	6, 4, 3, 2, 1.5
1.6	0.35	0.2	78	2
...	1.8	...	0.35	0.2	...	80	6, 4, 3, 2, 1.5
2.0	0.4	0.25	82	2
...	2.2	...	0.45	0.25	85	...	6, 4, 3, 2
2.5	0.45	0.35	...	90	6, 4, 3, 2
3	0.5	0.35	95	...	6, 4, 3, 2
...	3.5	...	0.6	0.35	...	100	6, 4, 3, 2
4	0.7	0.5	105	...	6, 4, 3, 2
...	4.5	...	0.75	0.5	...	110	6, 4, 3, 2
5	0.8	0.5	115	...	6, 4, 3, 2
...	...	5.5	...	(0.5)	120	...	6, 4, 3, 2
6	1	0.75	...	125	6, 4, 3, 2
...	7	...	1	0.75	130	...	6, 4, 3, 2
8	1.25	1	0.75	135	6, 4, 3, 2
...	...	9	1.25	...	1, 0.75	140	6, 4, 3, 2
10	1.5	1.25	1, 0.75	145	6, 4, 3, 2
...	...	11	1.5	...	1, 0.75	...	150	...	6, 4, 3, 2
12	1.75	1.25	1.5, 1	155	6, 4, 3
...	14	...	2	1.5	1.25 ^a , 1	160	6, 4, 3
...	...	15	1.5, 1	165	6, 4, 3
16	2	1.5	1	...	170	...	6, 4, 3
...	...	17	1.5, 1	175	6, 4, 3
...	18	...	2.5	1.5	2, 1	180	6, 4, 3
20	2.5	1.5	2, 1	185	6, 4, 3
...	22	...	2.5	1.5	2, 1	...	190	...	6, 4, 3
24	3	2	1.5, 1	195	6, 4, 3
...	...	25	2, 1.5, 1	200	6, 4, 3
...	...	26	1.5	205	6, 4, 3
...	27	...	3	2	1.5, 1	...	210	...	6, 4, 3
...	...	28	2, 1.5, 1	215	6, 4, 3
30	3.5	2	(3), 1.5, 1	220	6, 4, 3
...	...	32	2, 1.5	225	6, 4, 3
...	33	...	3.5	2	(3), 1.5	230	6, 4, 3
...	...	35 ^b	1.5	235	6, 4, 3
36	4	...	3, 2, 1.5	...	240	...	6, 4, 3
...	...	38	1.5	245	6, 4, 3
...	39	...	4	...	3, 2, 1.5	250	6, 4, 3
...	...	40	3, 2, 1.5	255	6, 4
42	45	...	4.5	...	4, 3, 2, 1.5	...	260	...	6, 4
48	5	...	4, 3, 2, 1.5	265	6, 4
...	...	50	3, 2, 1.5	270	6, 4
...	52	...	5	...	4, 3, 2, 1.5	275	6, 4
...	...	55	4, 3, 2, 1.5	280	6, 4
56	5.5	...	4, 3, 2, 1.5	285	6, 4
...	...	58	4, 3, 2, 1.5	290	6, 4
...	60	...	5.5	...	4, 3, 2, 1.5	295	6, 4
...	...	62	4, 3, 2, 1.5	...	300	...	6, 4
64	6	...	4, 3, 2, 1.5
...	...	65	4, 3, 2, 1.5
...	68	...	6	...	4, 3, 2, 1.5

^a Only for spark plugs for engines.^b Only for locking nuts for bearings.

All dimensions are in millimeters. Pitches in parentheses () are to be avoided as far as possible.

Comparison of Metric Thread Systems

Metric Series Threads — A comparison of Maximum Metal Dimensions of British (*BS 1095*), French (*NF E03-104*), German (*DIN 13*), and Swiss (*VSM 12003*) Systems

Nominal Size and Major Bolt Diam.	Pitch	Pitch Diam.	Bolt				Nut				
			Minor Diameter				Major Diameter			Minor Diameter	
			British	French	German	Swiss	British & German	French	Swiss	French, German & Swiss	British
6	1	5.350	4.863	4.59	4.700	4.60	6.000	6.108	6.100	4.700	4.863
7	1	6.350	5.863	5.59	5.700	5.60	7.000	7.108	7.100	5.700	5.863
8	1.25	7.188	6.579	6.24	6.376	6.25	8.000	8.135	8.124	6.376	6.579
9	1.25	8.188	7.579	7.24	7.376	7.25	9.000	9.135	9.124	7.376	7.579
10	1.5	9.026	8.295	7.89	8.052	7.90	10.000	10.162	10.150	8.052	8.295
11	1.5	10.026	9.295	8.89	9.052	8.90	11.000	11.162	11.150	9.052	9.295
12	1.75	10.863	10.011	9.54	9.726	9.55	12.000	12.189	12.174	9.726	10.011
14	2	12.701	11.727	11.19	11.402	11.20	14.000	14.216	14.200	11.402	11.727
16	2	14.701	13.727	13.19	13.402	13.20	16.000	16.216	16.200	13.402	13.727
18	2.5	16.376	15.158	14.48	14.752	14.50	18.000	18.270	18.250	14.752	15.158
20	2.5	18.376	17.158	16.48	16.752	16.50	20.000	20.270	20.250	16.752	17.158
22	2.5	20.376	19.158	18.48	18.752	18.50	22.000	22.270	22.250	18.752	19.158
24	3	22.051	20.590	19.78	20.102	19.80	24.000	24.324	24.300	20.102 ^a	20.590
27	3	25.051	23.590	22.78	23.102	22.80	27.000	27.324	27.300	23.102 ^b	23.590
30	3.5	27.727	26.022	25.08	25.454	25.10	30.000	30.378	30.350	25.454	26.022
33	3.5	30.727	29.022	28.08	28.454	28.10	33.000	33.378	33.350	28.454	29.022
36	4	33.402	31.453	30.37	30.804	30.40	36.000	36.432	36.400	30.804	31.453
39	4	36.402	34.453	33.37	33.804	33.40	39.000	39.432	39.400	33.804	34.453
42	4.5	39.077	36.885	35.67	36.154	35.70	42.000	42.486	42.450	36.154	36.885
45	4.5	42.077	39.885	38.67	39.154	38.70	45.000	45.486	45.450	39.154	39.885
48	5	41.752	42.316	40.96	41.504	41.00	48.000	48.540	48.500	41.504	42.316
52	5	48.752	46.316	44.96	45.504	45.00	52.000	52.540	52.500	45.504	46.316
56	5.5	52.428	49.748	48.26	48.856	48.30	56.000	56.594	56.550	48.856	49.748
60	5.5	56.428	53.748	52.26	52.856	52.30	60.000	60.594	60.550	52.856	53.748

^aThe value shown is given in the German Standard; the value in the French Standard is 20.002; and in the Swiss Standard, 20.104.

^bThe value shown is given in the German Standard; the value in the French Standard is 23.002; and in the Swiss Standard, 23.104.

All dimensions are in mm.

ACME SCREW THREADS

American National Standard Acme Screw Threads

This American National Standard ASME/ANSI B1.5-1997 is a revision of American Standard ANSI B1.5-1988 and provides for two general applications of Acme threads, namely, General Purpose and Centralizing.

The limits and tolerances in this standard relate to single-start Acme threads, and may be used, if considered suitable, for multi-start Acme threads, which provide fast relative traversing motion when this is necessary. For information on additional allowances for multi-start Acme threads, see later section on page 1828.

General Purpose Acme Threads.—Three classes of General Purpose threads, 2G, 3G, and 4G, are provided in the standard, each having clearance on all diameters for free movement, and may be used in assemblies with the internal thread rigidly fixed and movement of the external thread in a direction perpendicular to its axis limited by its bearing or bearings. It is suggested that external and internal threads of the same class be used together for general purpose assemblies, Class 2G being the preferred choice. If less backlash or end play is desired, Classes 3G and 4G are provided. Class 5G is not recommended for new designs.

Thread Form: The accompanying Fig. 1 shows the thread form of these General Purpose threads, and the formulas accompanying the figure determine their basic dimensions. Table 1 gives the basic dimensions for the most generally used pitches.

Angle of Thread: The angle between the sides of the thread, measured in an axial plane, is 29 degrees. The line bisecting this 29-degree angle shall be perpendicular to the axis of the screw thread.

Thread Series: A series of diameters and associated pitches is recommended in the Standard as preferred. These diameters and pitches have been chosen to meet present needs with the fewest number of items in order to reduce to a minimum the inventory of both tools and gages. This series of diameters and associated pitches is given in Table 3.

Chamfers and Fillets: General Purpose external threads may have the crest corner chamfered to an angle of 45 degrees with the axis to a maximum width of $P/15$, where P is the pitch. This corresponds to a maximum depth of chamfer flat of $0.0945P$.

Basic Diameters: The max major diameter of the external thread is basic and is the nominal major diameter for all classes. The min pitch diameter of the internal thread is basic and is equal to the basic major diameter minus the basic height of the thread, h . The basic minor diameter is the min minor diameter of the internal thread. It is equal to the basic major diameter minus twice the basic thread height, $2h$.

Length of Engagement: The tolerances specified in this standard are applicable to lengths of engagement not exceeding twice the nominal major diameter.

Major and Minor Diameter Allowances: A minimum diametral clearance is provided at the minor diameter of all external threads by establishing the maximum minor diameter 0.020 inch below the basic minor diameter of the nut for pitches of 10 threads per inch and coarser, and 0.010 inch for finer pitches. A minimum diametral clearance at the major diameter is obtained by establishing the minimum major diameter of the internal thread 0.020 inch above the basic major diameter of the screw for pitches of 10 threads per inch and coarser, and 0.010 inch for finer pitches.

Major and Minor Diameter Tolerances: The tolerance on the external thread major diameter is $0.05P$, where P is the pitch, with a minimum of 0.005 inch. The tolerance on the internal thread major diameter is 0.020 inch for 10 threads per inch and coarser and 0.010 for finer pitches. The tolerance on the external thread minor diameter is $1.5 \times$ pitch diameter tolerance. The tolerance on the internal thread minor diameter is $0.05P$ with a minimum of 0.005 inch.

**ANSI General Purpose Acme Thread Form ASME/ANSI B1.5-1997 (R2004),
and Stub Acme Screw Thread Form ASME/ANSI B1.8-1988 (R2006)**

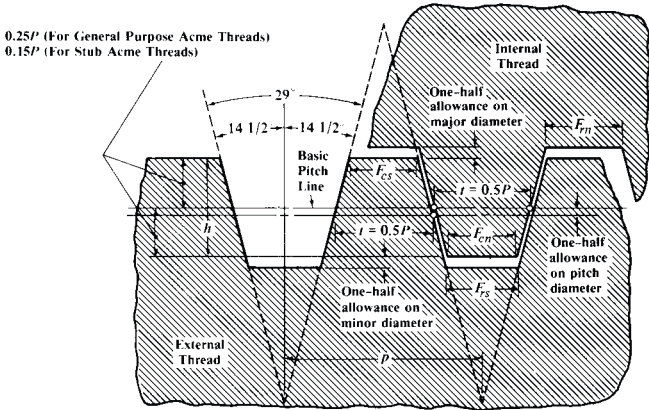

Fig. 1. General Purpose and Stub Acme Thread Forms

Formulas for Basic Dimensions of General Purpose and Stub Acme Screw Threads

General Purpose	Stub Acme Threads
Pitch = $P = 1 \div \text{No. threads per inch, } n$	Pitch = $P = 1 \div \text{No. threads per inch, } n$
Basic thread height $h = 0.5P$	Basic thread height $h = 0.3P$
Basic thread thickness $t = 0.5P$	Basic thread thickness $t = 0.5P$
Basic flat at crest $F_{cn} = 0.3707P$ (internal thread)	Basic flat at crest $F_{cn} = 0.4224P$ (internal thread)
Basic flat at crest $F_{cs} = 0.3707P - 0.259 \times$ (pitch dia. allowance on ext. thd.)	Basic flat at crest $F_{cs} = 0.4224P - 0.259 \times$ (pitch dia. allowance on ext. thread)
$F_m = 0.3707P - 0.259 \times$ (major dia. allowance on internal thread)	$F_m = 0.4224P - 0.259 \times$ (major dia. allowance on internal thread)
$F_{rs} = 0.3707P - 0.259 \times$ (minor dia. allowance on ext. thread - pitch dia. allowance on ext. thread)	$F_{rs} = 0.4224P - 0.259 \times$ (minor dia. allowance on ext. thread - pitch dia. allowance on ext. thread)

Pitch Diameter Allowances and Tolerances: Allowances on the pitch diameter of General Purpose Acme threads are given in [Table 4](#). Pitch diameter tolerances are given in [Table 5](#). The ratios of the pitch diameter tolerances of Classes 2G, 3G, and 4G, General Purpose threads are 3.0, 1.4, and 1, respectively.

An increase of 10 per cent in the allowance is recommended for each inch, or fraction thereof, that the length of engagement exceeds two diameters.

Application of Tolerances: The tolerances specified are designed to ensure interchangeability and maintain a high grade of product. The tolerances on diameters of the internal thread are plus, being applied from minimum sizes to above the minimum sizes. The tolerances on diameters of the external thread are minus, being applied from the maximum sizes to below the maximum sizes. The pitch diameter (or thread thickness) tolerances for an external or internal thread of a given class are the same. The thread thickness tolerance is 0.259 times the pitch diameter tolerance.

Limiting Dimensions: Limiting dimensions of General Purpose Acme screw threads in the recommended series are given in [Table 2b](#). These limits are based on the formulas in [Table 2a](#).

For combinations of pitch and diameter other than those in the recommended series, the formulas in [Table 2a](#) and the data in [Tables 4](#) and [5](#) make it possible to readily determine the limiting dimensions required.

A diagram showing the disposition of allowances, tolerances, and crest clearances for General Purpose Acme threads appears on page [1827](#).

Stress Area of General Purpose Acme Threads: For computing the tensile strength of the thread section, the minimum stress area based on the mean of the minimum pitch diameter d_2 min. and the minimum minor diameter d_1 max. of the external thread is used:

$$\text{Stress Area} = 3.1416 \left(\frac{d_2 \text{ min.} + d_1 \text{ max.}}{4} \right)^2$$

where d_2 min. and d_1 max. may be computed by Formulas 4 and 6, [Table 2a](#) or taken from [Table 2b](#).

Shear Area of General Purpose Acme Threads: For computing the shear area per inch length of engagement of the external thread, the maximum minor diameter of the internal thread D_1 max., and the minimum pitch diameter of the external thread D_2 min., [Table 2b](#) or Formulas 12 and 4, [Table 2a](#), are used:

$$\text{Shear Area} = 3.1416 D_1 \text{ max.} [0.5 + n \tan 14\frac{1}{2}^\circ (D_2 \text{ min.} - D_1 \text{ max.})]$$

Acme Thread Abbreviations.—The following abbreviations are recommended for use on drawings and in specifications, and on tools and gauges:

ACME = Acme threads

G = General Purpose

C = Centralizing

P = pitch

L = lead

LH = left hand

Designation of General Purpose Acme Threads.—The examples listed below are given here to show how General Purpose Acme threads are designated on drawings and tools:

1.750-4 ACME-2G indicates a General Purpose Class 2G Acme thread of 1.750-inch major diameter, 4 threads per inch, single thread, right hand. The same thread, but left hand, is designated 1.750-4 ACME-2G-LH.

2.875-0.4P-0.8L-ACME-3G indicates a General Purpose Class 3G Acme thread of 2.875-inch major diameter, pitch 0.4 inch, lead 0.8 inch, double thread, right hand.

Multiple Start Acme Threads.—The tabulated diameter-pitch data with allowances and tolerances relate to single-start threads. These data, as tabulated, may be and often are used for two-start Class 2G threads but this usage generally requires reduction of the full working tolerances to provide a greater allowance or clearance zone between the mating threads to assure satisfactory assembly.

When the class of thread requires smaller working tolerances than the 2G class or when threads with 3, 4, or more starts are required, some additional allowances or increased tolerances or both may be needed to ensure adequate working tolerances and satisfactory assembly of mating parts.

It is suggested that the allowances shown in [Table 4](#) be used for all external threads and that allowances be applied to internal threads in the following ratios: for two-start threads, 50 per cent of the allowances shown in the Class 2G, 3G and 4G columns of [Table 4](#); for

Table 1. American National Standard General Purpose Acme Screw Thread Form — Basic Dimensions ASME/ANSI B1.5-1997 (R2004)

Thds. per Inch <i>n</i>	Pitch, $P = 1/n$	Height of Thread (Basic), $h = P/2$	Total Height of Thread, $h_s = P/2 + \frac{1}{2}$ allowance ^a	Thread Thickness (Basic), $t = P/2$	Width of Flat	
					Crest of Internal Thread (Basic), $F_{cr} = 0.3707P$	Root of Internal Thread, F_m $0.3707P - 0.259 \times$ allowance ^a
16	0.06250	0.03125	0.0362	0.03125	0.0232	0.0206
14	0.07143	0.03571	0.0407	0.03571	0.0265	0.0239
12	0.08333	0.04167	0.0467	0.04167	0.0309	0.0283
10	0.10000	0.05000	0.0600	0.05000	0.0371	0.0319
8	0.12500	0.06250	0.0725	0.06250	0.0463	0.0411
6	0.16667	0.08333	0.0933	0.08333	0.0618	0.0566
5	0.20000	0.10000	0.1100	0.10000	0.0741	0.0689
4	0.25000	0.12500	0.1350	0.12500	0.0927	0.0875
3	0.33333	0.16667	0.1767	0.16667	0.1236	0.1184
2½	0.40000	0.20000	0.2100	0.20000	0.1483	0.1431
2	0.50000	0.25000	0.2600	0.25000	0.1853	0.1802
1½	0.66667	0.33333	0.3433	0.33333	0.2471	0.2419
1¼	0.75000	0.37500	0.3850	0.37500	0.2780	0.2728
1	1.00000	0.50000	0.5100	0.50000	0.3707	0.3655

All dimensions are in inches.

^a Allowance is 0.020 inch for 10 threads per inch and coarser, and 0.010 inch for finer threads.

Table 2a. American National Standard General Purpose Acme Single-Start Screw Threads — Formulas for Determining Diameters ASME/ANSI B1.5-1997 (R2004)

<p>D = Basic Major Diameter and Nominal Size, in Inches. P = Pitch = $1 \div$ Number of Threads per Inch. E = Basic Pitch Diameter = $D - 0.5P$ K = Basic Minor Diameter = $D - P$</p>	
No.	External Threads (Screws)
1	Major Dia., Max. = D
2	Major Dia., Min. = D minus $0.05P^a$ but not less than 0.005.
3	Pitch Dia., Max. = E minus allowance from Table 4.
4	Pitch Dia., Min. = Pitch Dia., Max. (Formula 3) minus tolerance from Table 5.
5	Minor Dia., Max. = K minus 0.020 for 10 threads per inch and coarser and 0.010 for finer-pitches.
6	Minor Dia., Min. = Minor Dia., Max. (Formula 5) minus $1.5 \times$ pitch diameter tolerance from Table 5.
	Internal Threads (Nuts)
7	Major Dia., Min. = D plus 0.020 for 10 threads per inch and coarser and 0.010 for finer pitches.
8	Major Dia., Max. = Major Dia., Min. (Formula 7) plus 0.020 for 10 threads per inch and coarser and 0.010 for finer pitches.
9	Pitch Dia., Min. = E
10	Pitch Dia., Max. = Pitch Dia., Min. (Formula 9) plus tolerance from Table 5.
11	Minor Dia., Min. = K
12	Minor Dia., Max. = Minor Dia., Min. (Formula 11) plus $0.05P^a$ but not less than 0.005.

^a If P is between two recommended pitches listed in Table 3, use the coarser of the two pitches in this formula instead of the actual value of P .

Table 2b. Limiting Dimensions of ANSI General Purpose Acme Single-Start Screw Threads ASME/ANSI B1.5-1988

Nominal Diameter, D		$\frac{1}{4}$	$\frac{5}{16}$	$\frac{3}{8}$	$\frac{7}{16}$	$\frac{1}{2}$	$\frac{5}{8}$	$\frac{3}{4}$	$\frac{7}{8}$	1	$1\frac{1}{8}$	$1\frac{1}{4}$	$1\frac{3}{8}$
Threads per Inch ^h		16	14	12	12	10	8	6	6	5	5	5	4
Limiting Dimensions		External Threads											
Classes 2G, 3G, and 4G Major Diameter	Max (D)	0.2500	0.3125	0.3750	0.4375	0.5000	0.6250	0.7500	0.8750	1.0000	1.1250	1.2500	1.3750
	Min	0.2450	0.3075	0.3700	0.4325	0.4950	0.6188	0.7417	0.8667	0.9900	1.1150	1.2400	1.3625
Classes 2G, 3G, and 4G Minor Diameter	Max	0.1775	0.2311	0.2817	0.3442	0.3800	0.4800	0.5633	0.6883	0.7800	0.9050	1.0300	1.1050
	Min	0.1618	0.2140	0.2632	0.3253	0.3594	0.4570	0.5372	0.6615	0.7509	0.8753	0.9998	1.0720
Class 2G, Minor Diameter	Min	0.1702	0.2231	0.2730	0.3354	0.3704	0.4693	0.5511	0.6758	0.7664	0.8912	1.0159	1.0896
Class 3G, Minor Diameter	Min	0.1722	0.2254	0.2755	0.3379	0.3731	0.4723	0.5546	0.6794	0.7703	0.8951	1.0199	1.0940
Class 2G, Pitch Diameter	Max	0.2148	0.2728	0.3284	0.3909	0.4443	0.5562	0.6598	0.7842	0.8920	1.0165	1.1411	1.2406
	Min	0.2043	0.2614	0.3161	0.3783	0.4306	0.5408	0.6424	0.7663	0.8726	0.9967	1.1210	1.2188
Class 3G, Pitch Diameter	Max	0.2158	0.2738	0.3296	0.3921	0.4458	0.5578	0.6615	0.7861	0.8940	1.0186	1.1433	1.2430
	Min	0.2109	0.2685	0.3238	0.3862	0.4394	0.5506	0.6534	0.7778	0.8849	1.0094	1.1339	1.2327
Class 4G, Pitch Diameter	Max	0.2168	0.2748	0.3309	0.3934	0.4472	0.5593	0.6632	0.7880	0.8960	1.0208	1.1455	1.2453
	Min	0.2133	0.2710	0.3268	0.3892	0.4426	0.5542	0.6574	0.7820	0.8895	1.0142	1.1388	1.2380
		Internal Threads											
Classes 2G, 3G, and 4G Major Diameter	Min	0.2600	0.3225	0.3850	0.4475	0.5200	0.6450	0.7700	0.8950	1.0200	1.1450	1.2700	1.3950
	Max	0.2700	0.3325	0.3950	0.4575	0.5400	0.6650	0.7900	0.9150	1.0400	1.1650	1.2900	1.4150
Classes 2G, 3G, and 4G Minor Diameter	Min	0.1875	0.2411	0.2917	0.3542	0.4000	0.5000	0.5833	0.7083	0.8000	0.9250	1.0500	1.1250
	Max	0.1925	0.2461	0.2967	0.3592	0.4050	0.5062	0.5916	0.7166	0.8100	0.9350	1.0600	1.1375
Class 2G, Pitch Diameter	Min	0.2188	0.2768	0.3333	0.3958	0.4500	0.5625	0.6667	0.7917	0.9000	1.0250	1.1500	1.2500
	Max	0.2293	0.2882	0.3456	0.4084	0.4637	0.5779	0.6841	0.8096	0.9194	1.0448	1.1701	1.2720
Class 3G, Pitch Diameter	Min	0.2188	0.2768	0.3333	0.3958	0.4500	0.5625	0.6667	0.7917	0.9000	1.0250	1.1500	1.2500
	Max	0.2237	0.2821	0.3391	0.4017	0.4564	0.5697	0.6748	0.8000	0.9091	1.0342	1.1594	1.2603
Class 4G, Pitch Diameter	Min	0.2188	0.2768	0.3333	0.3958	0.4500	0.5625	0.6667	0.7917	0.9000	1.0250	1.1500	1.2500
	Max	0.2223	0.2806	0.3374	0.4000	0.4546	0.5676	0.6725	0.7977	0.9065	1.0316	1.1567	1.2573

Table 2b. (Continued) Limiting Dimensions of ANSI General Purpose Acme Single-Start Screw Threads ASME/ANSI B1.5-1988

Nominal Diameter, D		$1\frac{1}{2}$	$1\frac{3}{4}$	2	$2\frac{1}{4}$	$2\frac{1}{2}$	$2\frac{3}{4}$	3	$3\frac{1}{2}$	4	$4\frac{1}{2}$	5
		Threads per Inch ^a										
Limiting Dimensions		External Threads										
Classes 2G, 3G, and 4G Major Diameter	Max (D)	1.5000	1.7500	2.0000	2.2500	2.5000	2.7500	3.0000	3.5000	4.0000	4.5000	5.0000
	Min	1.4875	1.7375	1.9875	2.2333	2.4833	2.7333	2.9750	3.4750	3.9750	4.4750	4.9750
Classes 2G, 3G, and 4G Minor Diameter	Max	1.2300	1.4800	1.7300	1.8967	2.1467	2.3967	2.4800	2.9800	3.4800	3.9800	4.4800

Table 3. General Purpose Acme Single-Start Screw Thread Data ASME/ANSI B1.5-1988

Identification		Basic Diameters			Thread Data							
Nominal Sizes (All Classes)	Threads per Inch, ^a <i>n</i>	Classes 2G, 3G, and 4G			Pitch, <i>P</i>	Thickness at Pitch Line, <i>t = P/2</i>	Basic Height of Thread, <i>h = P/2</i>	Basic Width of Flat, <i>F = 0.3707P</i>	Lead Angle λ at Basic Pitch Diameter ^b Classes 2G, 3G, and 4G		Shear Area ^b Class 3G	Stress Area ^c Class 3G
		Major Diameter, <i>D</i>	Pitch Diameter, <i>D₂ = D - h</i>	Minor Diameter, <i>D₁ = D - 2h</i>					Deg	Min		
1/4	16	0.2500	0.2188	0.1875	0.06250	0.03125	0.03125	0.0232	5	12	0.350	0.0285
5/16	14	0.3125	0.2768	0.2411	0.07143	0.03571	0.03571	0.0265	4	42	0.451	0.0474
3/8	12	0.3750	0.3333	0.2917	0.08333	0.04167	0.04167	0.0309	4	33	0.545	0.0699
7/16	12	0.4375	0.3958	0.3542	0.08333	0.04167	0.04167	0.0309	3	50	0.660	0.1022
1/2	10	0.5000	0.4500	0.4000	0.10000	0.05000	0.05000	0.0371	4	3	0.749	0.1287
5/8	8	0.6250	0.5625	0.5000	0.12500	0.06250	0.06250	0.0463	4	3	0.941	0.2043
3/4	6	0.7500	0.6667	0.5833	0.16667	0.08333	0.08333	0.0618	4	33	1.108	0.2848
7/8	6	0.8750	0.7917	0.7083	0.16667	0.08333	0.08333	0.0618	3	50	1.339	0.4150
1	5	1.0000	0.9000	0.8000	0.20000	0.10000	0.10000	0.0741	4	3	1.519	0.5354
1 1/8	5	1.1250	1.0250	0.9250	0.20000	0.10000	0.10000	0.0741	3	33	1.751	0.709
1 1/4	5	1.2500	1.1500	1.0500	0.20000	0.10000	0.10000	0.0741	3	10	1.983	0.907
1 3/8	4	1.3750	1.2500	1.1250	0.25000	0.12500	0.12500	0.0927	3	39	2.139	1.059
1 1/2	4	1.5000	1.3750	1.2500	0.25000	0.12500	0.12500	0.0927	3	19	2.372	1.298
1 3/4	4	1.7500	1.6250	1.5000	0.25000	0.12500	0.12500	0.0927	2	48	2.837	1.851
2	4	2.0000	1.8750	1.7500	0.25000	0.12500	0.12500	0.0927	2	26	3.301	2.501
2 1/4	3	2.2500	2.0833	1.9167	0.33333	0.16667	0.16667	0.1236	2	55	3.643	3.049
2 1/2	3	2.5000	2.3333	2.1667	0.33333	0.16667	0.16667	0.1236	2	36	4.110	3.870
2 3/4	3	2.7500	2.5833	2.4167	0.33333	0.16667	0.16667	0.1236	2	21	4.577	4.788
3	2	3.0000	2.7500	2.5000	0.50000	0.25000	0.25000	0.1853	3	19	4.786	5.27
3 1/2	2	3.5000	3.2500	3.0000	0.50000	0.25000	0.25000	0.1853	2	48	5.73	7.50
4	2	4.0000	3.7500	3.5000	0.50000	0.25000	0.25000	0.1853	2	26	6.67	10.12
4 1/2	2	4.5000	4.2500	4.0000	0.50000	0.25000	0.25000	0.1853	2	9	7.60	13.13
5	2	5.0000	4.7500	4.5000	0.50000	0.25000	0.25000	0.1853	1	55	8.54	16.53

^a All other dimensions are given in inches.

^b Per inch length of engagement of the external thread in line with the minor diameter crests of the internal thread. Figures given are the minimum shear area based on max D_1 and min d_2 .

^c Figures given are the minimum stress area based on the mean of the minimum minor and pitch diameters of the external thread. See formulas for shear area and stress area on page 1828.

Table 4. American National Standard General Purpose Acme Single-Start Screw Threads — Pitch Diameter Allowances ASME/ANSI B1.5-1988

Nominal Size Range ^a		Allowances on External Threads ^b			Nominal Size Range ^a		Allowances on External Threads ^b		
		Class 2G ^c , 0.008 \sqrt{D}	Class 3G, 0.006 \sqrt{D}	Class 4G, 0.004 \sqrt{D}			Class 2G ^c , 0.008 \sqrt{D}	Class 3G, 0.006 \sqrt{D}	Class 4G, 0.004 \sqrt{D}
Above	To and Including				Above	To and Including			
0	$\frac{3}{16}$	0.0024	0.0018	0.0012	$\frac{1}{16}$	$\frac{1}{16}$	0.0098	0.0073	0.0049
$\frac{3}{16}$	$\frac{5}{16}$	0.0040	0.0030	0.0020	$\frac{1}{16}$	$\frac{1}{8}$	0.0105	0.0079	0.0052
$\frac{5}{16}$	$\frac{7}{16}$	0.0049	0.0037	0.0024	$\frac{1}{8}$	$\frac{2}{8}$	0.0113	0.0085	0.0057
$\frac{7}{16}$	$\frac{9}{16}$	0.0057	0.0042	0.0028	$\frac{2}{8}$	$\frac{3}{8}$	0.0120	0.0090	0.0060
$\frac{9}{16}$	$\frac{1}{2}$	0.0063	0.0047	0.0032	$\frac{2}{8}$	$\frac{2}{8}$	0.0126	0.0095	0.0063
$\frac{1}{2}$	$\frac{13}{16}$	0.0069	0.0052	0.0035	$\frac{2}{8}$	$\frac{2}{8}$	0.0133	0.0099	0.0066
$\frac{13}{16}$	$\frac{15}{16}$	0.0075	0.0056	0.0037	$\frac{2}{8}$	$\frac{3}{4}$	0.0140	0.0105	0.0070
$\frac{15}{16}$	$\frac{1}{8}$	0.0080	0.0060	0.0040	$\frac{3}{4}$	$\frac{3}{4}$	0.0150	0.0112	0.0075
$\frac{1}{8}$	$\frac{1}{4}$	0.0085	0.0064	0.0042	$\frac{3}{4}$	$\frac{4}{4}$	0.0160	0.0120	0.0080
$\frac{1}{4}$	$\frac{1}{2}$	0.0089	0.0067	0.0045	$\frac{4}{4}$	$\frac{4}{4}$	0.0170	0.0127	0.0085
$\frac{1}{2}$	$\frac{1}{2}$	0.0094	0.0070	0.0047	$\frac{4}{4}$	$\frac{5}{2}$	0.0181	0.0136	0.0091

All dimensions in inches. It is recommended that the sizes given in Table 3 be used whenever possible.

^a The values in columns for Classes 2G, 3G, and 4G are to be used for any size within the nominal size range shown. These values are calculated from the mean of the range.

^b An increase of 10 per cent in the allowance is recommended for each inch, or fraction thereof, that the length of engagement exceeds two diameters.

^c Allowances for the 2G Class of thread in this table also apply to American National Standard Stub Acme threads ASME/ANSI B 1.8-1988.

three-start threads, 75 per cent of these allowances; and for four-start threads, 100 per cent of these same values.

These values will provide for a 0.25-16 ACME-2G thread size, 0.002, 0.003, and 0.004 inch additional clearance for 2-, 3-, and 4-start threads, respectively. For a 5-2 ACME-3G thread size the additional clearances would be 0.0091, 0.0136, and 0.0181 inch, respectively. GO thread plug gages and taps would be increased by these same values. To maintain the same working tolerances on multi-start threads, the pitch diameter of the NOT GO thread plug gage would also be increased by these same values.

For multi-start threads with more than four starts, it is believed that the 100 per cent allowance provided by the above procedures would be adequate as index spacing variables would generally be no greater than on a four-start thread.

In general, for multi-start threads of Classes 2G, 3G, and 4G the percentages would be applied, usually, to allowances for the same class, respectively. However, where exceptionally good control over lead, angle, and spacing variables would produce close to theoretical values in the product, it is conceivable that these percentages could be applied to Class 3G or Class 4G allowances used on Class 2G internally threaded product. Also, these percentages could be applied to Class 4G allowances used on Class 3G internally threaded product. It is not advocated that any change be made in externally threaded products.

Designations for gages or tools for internal threads could cover allowance requirements as follows:

GO and NOT GO thread plug gages for: 2.875-0.4P-0.8L-ACME-2G with 50 per cent of the 4G internal thread allowance.

Centralizing Acme Threads.—The three classes of Centralizing Acme threads in American National Standard ASME/ANSI B1.5-1988, designated as 2C, 3C, and 4C, have limited clearance at the major diameters of internal and external threads so that a bearing at the major diameters maintains approximate alignment of the thread axis and prevents wedging on the flanks of the thread. An alternative series having centralizing control on the *minor*

Table 5. American National Standard General Purpose Acme Single-Start Screw Threads — Pitch Diameter Tolerances ASME/ANSI B1.5-1988

Nom. Dia., ^a <i>D</i>	Class of Thread			Nom. Dia., ^a <i>D</i>	Class of Thread		
	2G ^b	3G	4G		2G ^b	3G	4G
	Diameter Increment				Diameter Increment		
	$0.006\sqrt{D}$	$0.0028\sqrt{D}$	$0.002\sqrt{D}$		$0.006\sqrt{D}$	$0.0028\sqrt{D}$	$0.002\sqrt{D}$
$\frac{1}{4}$.00300	.00140	.00100	$1\frac{1}{2}$.00735	.00343	.00245
$\frac{5}{16}$.00335	.00157	.00112	$1\frac{3}{4}$.00794	.00370	.00265
$\frac{3}{8}$.00367	.00171	.00122	2	.00849	.00396	.00283
$\frac{7}{16}$.00397	.00185	.00132	$2\frac{1}{4}$.00900	.00420	.00300
$\frac{1}{2}$.00424	.00198	.00141	$2\frac{1}{2}$.00949	.00443	.00316
$\frac{5}{8}$.00474	.00221	.00158	$2\frac{3}{4}$.00995	.00464	.00332
$\frac{3}{4}$.00520	.00242	.00173	3	.01039	.00485	.00346
$\frac{7}{8}$.00561	.00262	.00187	$3\frac{1}{2}$.01122	.00524	.00374
1	.00600	.00280	.00200	4	.01200	.00560	.00400
$1\frac{1}{8}$.00636	.00297	.00212	$4\frac{1}{2}$.01273	.00594	.00424
$1\frac{1}{4}$.00671	.00313	.00224	5	.01342	.00626	.00447
$1\frac{3}{8}$.00704	.00328	.00235

Thds. per Inch ^c , <i>n</i>	Class of Thread			Thds. per Inch ^c , <i>n</i>	Class of Thread		
	2G ^b	3G	4G		2G ^b	3G	4G
	Pitch Increment				Pitch Increment		
	$0.030\sqrt{1/n}$	$0.014\sqrt{1/n}$	$0.010\sqrt{1/n}$		$0.030\sqrt{1/n}$	$0.014\sqrt{1/n}$	$0.010\sqrt{1/n}$
16	.00750	.00350	.00250	4	.01500	.00700	.00500
14	.00802	.00374	.00267	3	.01732	.00808	.00577
12	.00866	.00404	.00289	$2\frac{1}{2}$.01897	.00885	.00632
10	.00949	.00443	.00316	2	.02121	.00990	.00707
8	.01061	.00495	.00354	$1\frac{1}{2}$.02449	.01143	.00816
6	.01225	.00572	.00408	$1\frac{1}{3}$.02598	.01212	.00866
5	.01342	.00626	.00447	1	.03000	.01400	.01000

For any particular size of thread, the pitch diameter tolerance is obtained by adding the *diameter increment* from the upper half of the table to the *pitch increment* from the lower half of the table. *Example:* A $\frac{1}{4}$ -16 Acme-2G thread has a pitch diameter tolerance of $0.00300 + 0.00750 = 0.0105$ inch.

The equivalent tolerance on thread thickness is 0.259 times the pitch diameter tolerance.

^a For a nominal diameter between any two tabulated nominal diameters, use the diameter increment for the larger of the two tabulated nominal diameters.

^b Columns for the 2G Class of thread in this table also apply to American National Standard Stub Acme threads, ASME/ANSI B1.8-1988 (R2006).

^c All other dimensions are given in inches.

diameter is described on page 1844. For any combination of the three classes of threads covered in this standard some end play or backlash will result. Classes 5C and 6C are not recommended for new designs.

Application: These three classes together with the accompanying specifications are for the purpose of ensuring the interchangeable manufacture of Centralizing Acme threaded parts. Each user is free to select the classes best adapted to his particular needs. It is suggested that external and internal threads of the same class be used together for centralizing assemblies, Class 2C providing the maximum end play or backlash. If less backlash or end play is desired, Classes 3C and 4C are provided. The requirement for a centralizing fit is that the sum of the major diameter tolerance plus the major diameter allowance on the internal thread, and the major diameter tolerance on the external thread shall equal or be less than the pitch diameter allowance on the external thread. A Class 2C external thread, which has a larger pitch diameter allowance than either a Class 3C or 4C, can be used interchangeably with a Class 2C, 3C, or 4C internal thread and fulfill this requirement. Simi-

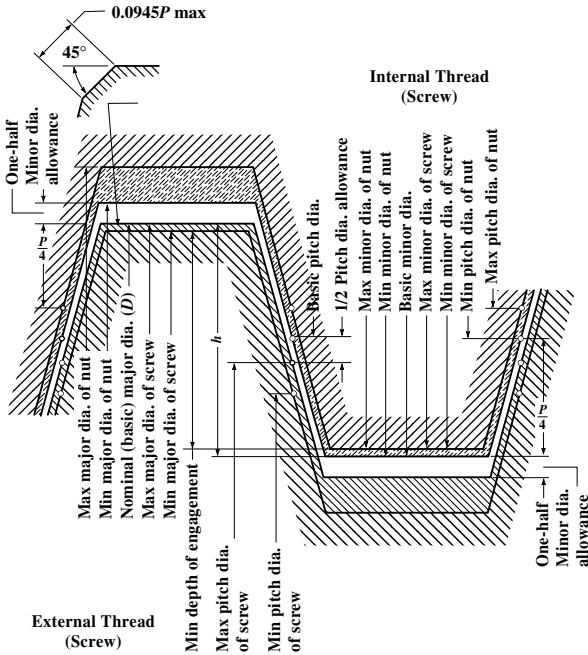

Fig. 2. Disposition of Allowances, Tolerances, and Crest Clearances for General Purpose Single-start Acme Threads (All Classes)

larly, a Class 3C external thread can be used interchangeably with a Class 3C or 4C internal thread, but only a Class 4C internal thread can be used with a Class 4C external thread.

Thread Form: The thread form is the same as the General Purpose Acme Thread and is shown in Fig. 3. The formulas in Table 7 determine the basic dimensions, which are given in Table 6 for the most generally used pitches.

Angle of Thread: The angle between the sides of the thread measured in an axial plane is 29 degrees. The line bisecting this 29-degree angle shall be perpendicular to the axis of the thread.

Chamfers and Fillets: External threads have the crest corners chamfered at an angle of 45 degrees with the axis to a minimum depth of $P/20$ and a maximum depth of $P/15$. These modifications correspond to a minimum width of chamfer flat of $0.0707P$ and a maximum width of $0.0945P$ (see Table 6, columns 6 and 7).

External threads for Classes 2C, 3C, and 4C may have a fillet at the minor diameter not greater than $0.1P$

Thread Series: A series of diameters and pitches is recommended in the Standard as preferred. These diameters and pitches have been chosen to meet present needs with the fewest number of items in order to reduce to a minimum the inventory of both tools and gages. This series of diameters and associated pitches is given in Table 9.

Table 6. American National Standard Centralizing Acme Screw Thread Form — Basic Dimensions ASME/ANSI B1.5-1988

Thds per Inch, n	Pitch, P	Height of Thread (Basic), $h = P/2$	Total Height of Thread (All External Threads) $h_t = h + \frac{1}{2}$ allowance ^a	Thread Thickness (Basic), $t = P/2$	45-Deg Chamfer Crest of External Threads		Max Fillet Radius, Root of Tapped Hole, $0.06P$	Fillet Radius at Min or Diameter of Screws Max (All) $0.10P$
					Min Depth, $0.05P$	Min Width of Chamfer Flat, $0.0707P$		
16	0.06250	0.03125	0.0362	0.03125	0.0031	0.0044	0.0038	0.0062
14	0.07143	0.03571	0.0407	0.03571	0.0036	0.0050	0.0038	0.0071
12	0.08333	0.04167	0.0467	0.04167	0.0042	0.0059	0.0050	0.0083
10	0.10000	0.05000	0.0600	0.05000	0.0050	0.0071	0.0060	0.0100
8	0.12500	0.06250	0.0725	0.06250	0.0062	0.0088	0.0075	0.0125
6	0.16667	0.08333	0.0933	0.08333	0.0083	0.0119	0.0100	0.0167
5	0.20000	0.10000	0.1100	0.10000	0.0100	0.0141	0.0120	0.0200
4	0.25000	0.12500	0.1350	0.12500	0.0125	0.0177	0.0150	0.0250
3	0.33333	0.16667	0.1767	0.16667	0.0167	0.0236	0.0200	0.0333
2½	0.40000	0.20000	0.2100	0.20000	0.0200	0.0283	0.0240	0.0400
2	0.50000	0.25000	0.2600	0.25000	0.0250	0.0354	0.0300	0.0500
1½	0.66667	0.33333	0.3433	0.33333	0.0330	0.0471	0.0400	0.0667
1¼	0.75000	0.37500	0.3850	0.37500	0.0380	0.0530	0.0450	0.0750
1	1.00000	0.50000	0.5100	0.50000	0.0500	0.0707	0.0600	0.1000

All dimensions in inches. See Fig. 3.

^a Allowance is 0.020 inch for 10 or less threads per inch and 0.010 inch for more than 10 threads per inch.

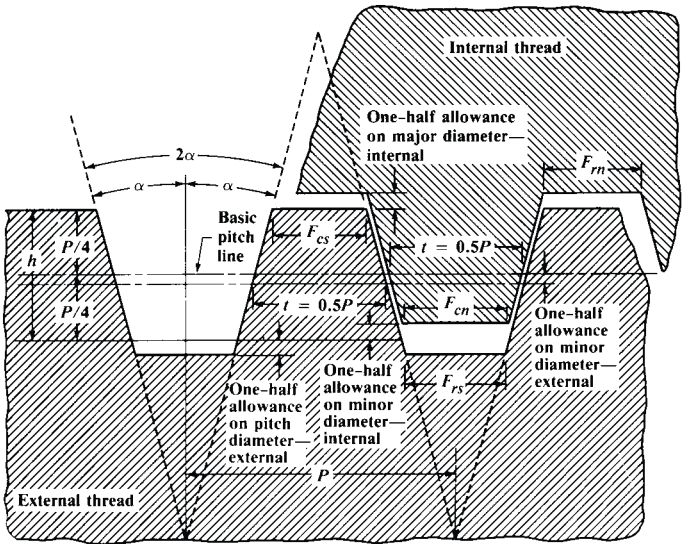

Fig. 3. Centralizing Acme Screw Thread Form

Basic Diameters: The maximum major diameter of the external thread is basic and is the nominal major diameter for all classes.

Table 7. Formulas for Finding Basic Dimensions of Centralizing Acme Screw Threads

Pitch = $P = 1 \div \text{No. threads per inch, } n$:	Basic thread height $h = 0.5P$
Basic thread thickness $t = 0.5P$	
Basic flat at crest $F_{cn} = 0.3707P + 0.259 \times (\text{minor diameter allowance on internal threads})$ (internal thread)	
Basic flat at crest $F_{cs} = 0.3707P - 0.259 \times (\text{pitch diameter allowance on external thread})$ (external thread)	
$F_{in} = 0.3707P - 0.259 \times (\text{major dia. allowance on internal thread})$	
$F_{ex} = 0.3707P - 0.259 \times (\text{minor dia. allowance on external thread} - \text{pitch dia. allowance on external thread})$	

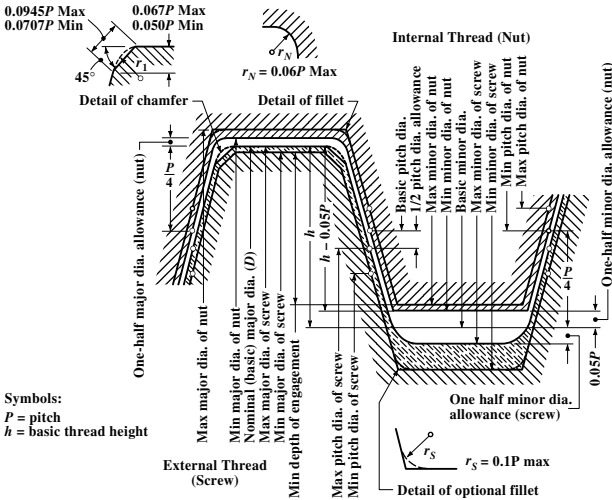

Fig. 4. Disposition of Allowances, Tolerances, and Crest Clearances for Centralizing Single-Start Acme Threads—Classes 2C, 3C, and 4C

The minimum pitch diameter of the internal thread is basic for all classes and is equal to the basic major diameter D minus the basic height of thread, h . The minimum minor diameter of the internal thread for all classes is $0.1P$ above basic.

Length of Engagement: The tolerances specified in this Standard are applicable to lengths of engagement not exceeding twice the nominal major diameter.

Pitch Diameter Allowances: Allowances applied to the pitch diameter of the external thread for all classes are given in Table 10.

Major and Minor Diameter Allowances: A minimum diametral clearance is provided at the minor diameter of all external threads by establishing the maximum minor diameter 0.020 inch below the basic minor diameter for 10 threads per inch and coarser, and 0.010 inch for finer pitches and by establishing the minimum minor diameter of the internal thread $0.1P$ greater than the basic minor diameter.

A minimum diametral clearance at the major diameter is obtained by establishing the minimum major diameter of the internal thread $0.001 \sqrt{D}$ above the basic major diameter. These allowances are shown in Table 12.

Table 8a. American National Standard Centralizing Acme Single-Start Screw Threads — Formulas for Determining Diameters ASME/ANSI B1.5-1988

D = Nominal Size or Diameter in Inches P = Pitch = $1 \div$ Number of Threads per Inch	
No.	Classes 2C, 3C, and 4C External Threads (Screws)
1	Major Dia., Max = D (Basic).
2	Major Dia., Min = D minus tolerance from Table 12, columns 7, 8, or 10.
3	Pitch Dia., Max = Int. Pitch Dia., Min (Formula 9) minus allowance from the appropriate Class 2C, 3C, or 4C column of Table 10.
4	Pitch Dia., Min = Ext. Pitch Dia., Max (Formula 3) minus tolerance from Table 11.
5	Minor Dia., Max = D minus P minus allowance from Table 12, column 3.
6	Minor Dia., Min = Ext. Minor Dia., Max (Formula 5) minus $1.5 \times$ Pitch Dia. tolerance from Table 11.
Classes 2C, 3C, and 4C Internal Threads (Nuts)	
7	Major Dia., Min = D plus allowance from Table 12, column 4.
8	Major Dia., Max = Int. Major Dia., Min (Formula 7) plus tolerance from Table 12, columns 7, 9, or 11.
9	Pitch Dia., Min = D minus $P/2$ (Basic).
10	Pitch Dia., Max = Int. Pitch Dia., Min (Formula 9) plus tolerance from Table 11.
11	Minor Dia., Min = D minus $0.9P$.
12	Minor Dia., Max = Int. Minor Dia., Min (Formula 11) plus tolerance from Table 12, column 6.

Major and Minor Diameter Tolerances: The tolerances on the major and minor diameters of the external and internal threads are listed in Table 12 and are based upon the formulas given in the column headings.

An increase of 10 per cent in the allowance is recommended for each inch or fraction thereof that the length of engagement exceeds two diameters.

For information on gages for Centralizing Acme threads the Standard ASME/ANSI B1.5 should be consulted.

Pitch Diameter Tolerances: Pitch diameter tolerances for Classes 2C, 3C and 4C for various practicable combinations of diameter and pitch are given in Table 11. The ratios of the pitch diameter tolerances of Classes 2C, 3C, and 4C are 3.0, 1.4, and 1, respectively.

Application of Tolerances: The tolerances specified are such as to insure interchangeability and maintain a high grade of product. The tolerances on the diameters of internal threads are plus, being applied from the minimum sizes to above the minimum sizes. The tolerances on the diameters of external threads are minus, being applied from the maximum sizes to below the maximum sizes. The pitch diameter tolerances for an external or internal thread of a given class are the same.

Limiting Dimensions: Limiting dimensions for Centralizing Acme threads in the preferred series of diameters and pitches are given in Tables 8b and 8c. These limits are based on the formulas in Table 8a.

For combinations of pitch and diameter other than those in the preferred series the formulas in Tables 8b and 8c and the data in the tables referred to therein make it possible to readily determine the limiting dimension required.

Designation of Centralizing Acme Threads.—The following examples are given to show how these Acme threads are designated on drawings, in specifications, and on tools and gages:

Example, 1.750-6-ACME-4C: Indicates a Centralizing Class 4C Acme thread of 1.750-inch major diameter, 0.1667-inch pitch, single thread, right-hand.

Table 8b. Limiting Dimensions of American National Standard Centralizing Acme Single-Start Screw Threads, Classes 2C, 3C, and 4C ASME/ANSI B1.5-1988

Nominal Diameter, D Threads per Inch ^a		$\frac{1}{2}$	$\frac{5}{8}$	$\frac{3}{4}$	$\frac{7}{8}$	1	$1\frac{1}{8}$	$1\frac{1}{4}$	$1\frac{3}{8}$	$1\frac{1}{2}$
		10	8	6	6	5	5	5	4	4
Limiting Dimensions		External Threads								
Classes 2C, 3C, and 4C, Major Diameter	Max	0.5000	0.6250	0.7500	0.8750	1.0000	1.1250	1.2500	1.3750	1.5000
Class 2C, Major Diameter	Min	0.4975	0.6222	0.7470	0.8717	0.9965	1.1213	1.2461	1.3709	1.4957
Class 3C, Major Diameter	Min	0.4989	0.6238	0.7487	0.8736	0.9985	1.1234	1.2483	1.3732	1.4982
Class 4C, Major Diameter	Min	0.4993	0.6242	0.7491	0.8741	0.9990	1.1239	1.2489	1.3738	1.4988
Classes 2C, 3C, and 4C, Minor Diameter	Max	0.3800	0.4800	0.5633	0.6883	0.7800	0.9050	1.0300	1.1050	1.2300
Class 2C, Minor Diameter	Min	0.3594	0.4570	0.5371	0.6615	0.7509	0.8753	0.9998	1.0719	1.1965
Class 3C, Minor Diameter	Min	0.3704	0.4693	0.5511	0.6758	0.7664	0.8912	1.0159	1.0896	1.2144
Class 4C, Minor Diameter	Min	0.3731	0.4723	0.5546	0.6794	0.7703	0.8951	1.0199	1.0940	1.2188
Class 2C, Pitch Diameter	Max	0.4443	0.5562	0.6598	0.7842	0.8920	1.0165	1.1411	1.2406	1.3652
	Min	0.4306	0.5408	0.6424	0.7663	0.8726	0.9967	1.1210	1.2186	1.3429
Class 3C, Pitch Diameter	Max	0.4458	0.5578	0.6615	0.7861	0.8940	1.0186	1.1433	1.2430	1.3677
	Min	0.4394	0.5506	0.6534	0.7778	0.8849	1.0094	1.1339	1.2327	1.3573
Class 4C, Pitch Diameter	Max	0.4472	0.5593	0.6632	0.7880	0.8960	1.0208	1.1455	1.2453	1.3701
	Min	0.4426	0.5542	0.6574	0.7820	0.8895	1.0142	1.1388	1.2380	1.3627
		Internal Threads								
Classes 2C, 3C, and 4C, Major Diameter	Min	0.5007	0.6258	0.7509	0.8759	1.0010	1.1261	1.2511	1.3762	1.5012
Classes 2C and 3C, Major Diameter	Max	0.5032	0.6286	0.7539	0.8792	1.0045	1.1298	1.2550	1.3803	1.5055
Class 4C, Major Diameter	Max	0.5021	0.6274	0.7526	0.8778	1.0030	1.1282	1.2533	1.3785	1.5036
Classes 2C, 3C, and 4C, Minor Diameter	Min	0.4100	0.5125	0.6000	0.7250	0.8200	0.9450	0.0700	1.1500	1.2750
	Max	0.04150	0.5187	0.6083	0.7333	0.8300	0.9550	1.0800	1.1625	1.2875
Class 2C, Pitch Diameter	Min	0.4500	0.5625	0.6667	0.7917	0.9000	1.0250	1.1500	1.2500	1.3750
	Max	0.4637	0.5779	0.6841	0.8096	0.9194	1.0448	1.1701	1.2720	1.3973
Class 3C, Pitch Diameter	Min	0.4500	0.5625	0.6667	0.7917	0.9000	1.0250	1.1500	1.2500	1.3750
	Max	0.4564	0.5697	0.6748	0.8000	0.9091	1.0342	1.1594	1.2603	1.3854
Class 4C, Pitch Diameter	Min	0.4500	0.5625	0.6667	0.7917	0.9000	1.0250	1.1500	1.2500	1.3750
	Max	0.4546	0.5676	0.6725	0.7977	0.9065	1.0316	1.1567	1.2573	1.3824

Table 8c. Limiting Dimensions of American National Standard Centralizing Acme Single-Start Screw Threads, Classes 2C, 3C, and 4C ASME/ANSI B1.5-1988

Nominal Diameter, <i>D</i>		1¼	2	2¼	2½	2¾	3	3½ ₂₁₂	4	4½	5
		Threads per Inch ^a									
Limiting Dimensions		4	4	3	3	3	2	2	2	2	2
		External Threads									
Classes 2C, 3C, and 4C, Major Diameter	Max	1.7500	2.0000	2.2500	2.5000	2.7500	3.0000	3.5000	4.0000	4.5000	5.0000
Class 2C, Major Diameter	Min	1.7454	1.9951	2.2448	2.4945	2.7442	2.9939	3.4935	3.9930	4.4926	4.9922
Class 3C, Major Diameter	Min	1.7480	1.9979	2.2478	2.4976	2.7475	2.9974	3.4972	3.9970	4.4968	4.9966
Class 4C, Major Diameter	Min	1.7487	1.9986	2.2485	2.4984	2.7483	2.9983	3.4981	3.9980	4.4979	4.9978
Classes 2C, 3C, and 4C, Minor Diameter	Max	1.4800	1.7300	1.8967	2.1467	2.3967	2.4800	2.9800	3.4800	3.9800	4.4800
Class 2C, Minor Diameter	Min	1.4456	1.6948	1.8572	2.1065	2.3558	2.4326	2.9314	3.4302	3.9291	4.4281
Class 3C, Minor Diameter	Min	1.4640	1.7136	1.8783	2.1279	2.3776	2.4579	2.9574	3.4568	3.9563	4.4558
Class 4C, Minor Diameter	Min	1.4685	1.7183	1.8835	2.1333	2.3831	2.4642	2.9638	3.4634	3.9631	4.4627
Class 2C, Pitch Diameter	Max	1.6145	1.8637	2.0713	2.3207	2.5700	2.7360	3.2350	3.7340	4.2330	4.7319
	Min	1.5916	1.8402	2.0450	2.2939	2.5427	2.7044	3.2026	3.7008	4.1991	4.6973
Class 3C, Pitch Diameter	Max	1.6171	1.8665	2.0743	2.3238	2.5734	2.7395	3.2388	3.7380	4.2373	4.7364
	Min	1.6064	1.8555	2.0620	2.3113	2.5607	2.7248	3.2237	3.7225	4.2215	4.7202
Class 4C, Pitch Diameter	Max	1.6198	1.8693	2.0773	2.3270	2.5767	2.7430	3.2425	3.7420	4.2415	4.7409
	Min	1.6122	1.8615	2.0685	2.3181	2.5676	2.7325	3.2317	3.7309	4.2302	4.7294
		Internal Threads									
Classes 2C, 3C, and 4C, Major Diameter	Min	1.7513	2.0014	2.2515	2.5016	2.7517	3.0017	3.5019	4.0020	4.5021	5.0022
Classes 2C and 3C, Major Diameter	Max	1.7559	2.0063	2.2567	2.5071	2.7575	3.0078	3.5084	4.0090	4.5095	5.0100
Class 4C, Major Diameter	Max	1.7539	2.0042	2.2545	2.5048	2.7550	3.0052	3.5056	4.0060	4.5063	5.0067
Classes 2C, 3C, and 4C, Minor Diameter	Min	1.5250	1.7750	1.9500	2.2000	2.4500	2.5500	3.0500	3.5500	4.0500	4.5500
	Max	1.5375	1.7875	1.9667	2.2167	2.4667	2.5750	3.0750	3.5750	4.0750	4.5750
Class 2C, Pitch Diameter	Min	1.6250	1.8750	2.0833	2.3333	2.5833	2.7500	3.2500	3.7500	4.2500	4.7500
	Max	1.6479	1.8985	2.1096	2.3601	2.6106	2.7816	3.2824	3.7832	4.2839	4.7846
Class 3C, Pitch Diameter	Min	1.6250	1.8750	2.0833	2.3333	2.5833	2.7500	3.2500	3.7500	4.2500	4.7500
	Max	1.6357	1.8860	2.0956	2.3458	2.5960	2.7647	3.2651	3.7655	4.2658	4.7662
Class 4C Pitch Diameter	Min	1.6250	1.8750	2.0833	2.3333	2.5833	2.7500	3.2500	3.7500	4.2500	4.7500
	Max	1.6326	1.8828	2.0921	2.3422	2.5924	2.7605	3.2608	3.7611	4.2613	4.7615

^a All other dimensions are in inches. The selection of threads per inch is arbitrary and for the purpose of establishing a standard.

Table 9. American National Standard Centralizing Acme Single-Start Screw Thread Data ASME/ANSI B1.5-1988

Identification		Diameters			Thread Data					
Nominal Sizes (All Classes)	Threads per Inch, ^a <i>n</i>	Centralizing, Classes 2C, 3C, and 4C			Pitch, <i>P</i>	Thickness at Pitch Line, <i>t = P/2</i>	Basic Height of Thread, <i>h = P/2</i>	Basic Width of Flat, <i>F = 0.3707P</i>	Lead Angle λ at Basic Pitch Diameter ^a	
		Basic Major Diameter, <i>D</i>	Pitch Diameter, <i>D₂ = (D - h)</i>	Minor Diameter, <i>D₁ = (D - 2h)</i>					Centralizing Classes 2C, 3C, and 4C,	
									Deg	Min
1/4	16	0.2500	0.2188	0.1875	0.06250	0.03125	0.03125	0.0232	5	12
5/16	14	0.3125	0.2768	0.2411	0.07143	0.03571	0.03571	0.0265	4	42
3/8	12	0.3750	0.3333	0.2917	0.08333	0.04167	0.04167	0.0309	4	33
7/16	12	0.4375	0.3958	0.3542	0.08333	0.04167	0.04167	0.0309	3	50
1/2	10	0.5000	0.4500	0.4000	0.10000	0.05000	0.05000	0.0371	4	3
5/8	8	0.6250	0.5625	0.5000	0.12500	0.06250	0.06250	0.0463	4	3
3/4	6	0.7500	0.6667	0.5833	0.16667	0.08333	0.08333	0.0618	4	33
7/8	6	0.8750	0.7917	0.7083	0.16667	0.08333	0.08333	0.0618	3	50
1	5	1.0000	0.9000	0.8000	0.20000	0.10000	0.10000	0.0741	4	3
1 1/8	5	1.1250	1.0250	0.9250	0.20000	0.10000	0.10000	0.0741	3	33
1 1/4	5	1.2500	1.1500	1.0500	0.20000	0.10000	0.10000	0.0741	3	10
1 3/8	4	1.3750	1.2500	1.1250	0.25000	0.12500	0.12500	0.0927	3	39
1 1/2	4	1.5000	1.3750	1.2500	0.25000	0.12500	0.12500	0.0927	3	19
1 3/4	4	1.7500	1.6250	1.5000	0.25000	0.12500	0.12500	0.0927	2	48
2	4	2.0000	1.8750	1.7500	0.25000	0.12500	0.12500	0.0927	2	26
2 1/4	3	2.2500	2.0833	1.9167	0.33333	0.16667	0.16667	0.1236	2	55
2 1/2	3	2.5000	2.3333	2.1667	0.33333	0.16667	0.16667	0.1236	2	36
2 3/4	3	2.7500	2.5833	2.4167	0.33333	0.16667	0.16667	0.1236	2	21
3	2	3.0000	2.7500	2.5000	0.50000	0.25000	0.25000	0.1853	3	19
3 1/2	2	3.5000	3.2500	3.0000	0.50000	0.25000	0.25000	0.1853	2	48
4	2	4.0000	3.7500	3.5000	0.50000	0.25000	0.25000	0.1853	2	26
4 1/2	2	4.5000	4.2500	4.0000	0.50000	0.25000	0.25000	0.1853	2	9
5	2	5.0000	4.7500	4.5000	0.50000	0.25000	0.25000	0.1853	1	55

^a All other dimensions are given in inches.

Table 10. American National Standard Centralizing Acme Single-Start Screw Threads — Pitch Diameter Allowances ASME/ANSI B1.5-1988

Nominal Size Range ^a		Allowances on External Threads ^b			Nominal Size Range ^a		Allowances on External Threads ^b		
Above	To and Including	Centralizing			Above	To and Including	Centralizing		
		Class 2C, 0.008 \sqrt{D}	Class 3C, 0.006 \sqrt{D}	Class 4C, 0.004 \sqrt{D}			Class 2C, 0.008 \sqrt{D}	Class 3C, 0.006 \sqrt{D}	Class 4C, 0.004 \sqrt{D}
0	$\frac{3}{16}$	0.0024	0.0018	0.0012	$\frac{1}{16}$	$\frac{1}{16}$	0.0098	0.0073	0.0049
$\frac{3}{16}$	$\frac{5}{16}$	0.0040	0.0030	0.0020	$\frac{1}{16}$	$\frac{1}{8}$	0.0105	0.0079	0.0052
$\frac{5}{16}$	$\frac{7}{16}$	0.0049	0.0037	0.0024	$\frac{1}{8}$	$\frac{2}{8}$	0.0113	0.0085	0.0057
$\frac{7}{16}$	$\frac{9}{16}$	0.0057	0.0042	0.0028	$\frac{2}{8}$	$\frac{23}{8}$	0.0120	0.0090	0.0060
$\frac{9}{16}$	$\frac{11}{16}$	0.0063	0.0047	0.0032	$\frac{23}{8}$	$\frac{23}{8}$	0.0126	0.0095	0.0063
$\frac{11}{16}$	$\frac{13}{16}$	0.0069	0.0052	0.0035	$\frac{23}{8}$	$\frac{23}{8}$	0.0133	0.0099	0.0066
$\frac{13}{16}$	$\frac{15}{16}$	0.0075	0.0056	0.0037	$\frac{23}{8}$	$\frac{3}{4}$	0.0140	0.0105	0.0070
$\frac{15}{16}$	$\frac{1}{2}$	0.0080	0.0060	0.0040	$\frac{3}{4}$	$\frac{3}{4}$	0.0150	0.0112	0.0075
$\frac{1}{2}$	$\frac{1}{4}$	0.0085	0.0064	0.0042	$\frac{3}{4}$	$\frac{4}{4}$	0.0160	0.0120	0.0080
$\frac{1}{4}$	$\frac{1}{2}$	0.0089	0.0067	0.0045	$\frac{4}{4}$	$\frac{4}{4}$	0.0170	0.0127	0.0085
$\frac{1}{2}$	$\frac{1}{4}$	0.0094	0.0070	0.0047	$\frac{4}{4}$	$\frac{5}{2}$	0.0181	0.0136	0.0091

All dimensions are given in inches.

It is recommended that the sizes given in Table 9 be used whenever possible.

^aThe values in columns for Classes 2C, 3C, and 4C are to be used for any size within the nominal size range columns. These values are calculated from the mean of the range.

^bAn increase of 10 per cent in the allowance is recommended for each inch, or fraction thereof, that the length of engagement exceeds two diameters.

Table 11. American National Standard Centralizing Acme Single-Start Screw Threads — Pitch Diameter Tolerances ASME/ANSI B1.5-1988

Nom. Dia., ^a $\frac{D}{D}$	Class of Thread and Diameter Increment			Nom. Dia., ^a $\frac{D}{D}$	Class of Thread and Diameter Increment		
	2C	3C	4C		2C	3C	4C
	0.006 \sqrt{D}	0.0028 \sqrt{D}	0.002 \sqrt{D}		0.006 \sqrt{D}	0.0028 \sqrt{D}	0.002 \sqrt{D}
$\frac{1}{4}$.00300	.00140	.00100	$\frac{1}{2}$.00735	.00343	.00245
$\frac{5}{16}$.00335	.00157	.00112	$\frac{1}{4}$.00794	.00370	.00265
$\frac{3}{8}$.00367	.00171	.00122	2	.00849	.00396	.00283
$\frac{7}{16}$.00397	.00185	.00132	$\frac{2}{4}$.00900	.00420	.00300
$\frac{1}{2}$.00424	.00198	.00141	$\frac{2}{2}$.00949	.00443	.00316
$\frac{5}{8}$.00474	.00221	.00158	$\frac{23}{4}$.00995	.00464	.00332
$\frac{3}{4}$.00520	.00242	.00173	3	.01039	.00485	.00346
$\frac{7}{8}$.00561	.00262	.00187	$\frac{3}{2}$.01122	.00524	.00374
1	.00600	.00280	.00200	4	.01200	.00560	.00400
$\frac{1}{8}$.00636	.00297	.00212	$\frac{4}{2}$.01273	.00594	.00424
$\frac{1}{4}$.00671	.00313	.00224	5	.01342	.00626	.00447
$\frac{1}{8}$.00704	.00328	.00235
Thds. per Inch, $\frac{n}{n}$	Class of Thread and Pitch Increment			Thds. per Inch, $\frac{n}{n}$	Class of Thread and Pitch Increment		
	2C	3C	4C		2C	3C	4C
	0.030 $\sqrt{1/n}$	0.014 $\sqrt{1/n}$	0.010 $\sqrt{1/n}$		0.030 $\sqrt{1/n}$	0.014 $\sqrt{1/n}$	0.010 $\sqrt{1/n}$
16	.00750	.00350	.00250	4	.01500	.00700	.00500
14	.00802	.00374	.00267	3	.01732	.00808	.00577
12	.00866	.00404	.00289	$\frac{2}{2}$.01897	.00885	.00632
10	.00949	.00443	.00316	2	.02121	.00990	.00707
8	.01061	.00495	.00354	$\frac{1}{2}$.02449	.01143	.00816
6	.01225	.00572	.00408	$\frac{1}{3}$.02598	.01212	.00866
5	.01342	.00626	.00447	1	.03000	.01400	.01000

All dimensions are given in inches.

For any particular size of thread, the pitch diameter tolerance is obtained by adding the diameter increment from the upper half of the table to the pitch increment from the lower half of the table. Example: A 0.250-16-ACME-2C thread has a pitch diameter tolerance of 0.00300 + 0.00750 = 0.0105 inch.

The equivalent tolerance on thread thickness is 0.259 times the pitch diameter tolerance.

^aFor a nominal diameter between any two tabulated nominal diameters, use the diameter increment for the larger of the two tabulated nominal diameters.

Table 12. American National Standard Centralizing Acme Single-Start Screw Threads — Tolerances and Allowances for Major and Minor Diameters ASME/ANSI B1.5-1988

Size (Nom.)	Thds ^a per Inch	Allowance From Basic Major and Minor Diameters (All Classes)			Tolerance on Minor Diam., ^{b,c} on All Internal Threads, (Plus 0.05P)	Tolerance on Major Diameter Plus on Internal, Minus on External Threads				
		Minor Diam., ^d All External Threads (Minus)	Internal Thread			Class 2C External and Internal Threads, $0.0035\sqrt{D}$	Class 3C		Class 4C	
			Major Diam., ^e (Plus (Plus $0.0010\sqrt{D}$))	Minor Diam., ^d (Plus 0.1P)			External Thread, $0.0015\sqrt{D}$	Internal Thread, $0.0035\sqrt{D}$	External Thread, $0.0010\sqrt{D}$	Internal Thread, $0.0020\sqrt{D}$
1/4	16	0.010	0.0005	0.0062	0.0050	0.0017	0.0007	0.0017	0.0005	0.0010
5/16	14	0.010	0.0006	0.0071	0.0050	0.0020	0.0008	0.0020	0.0006	0.0011
3/8	12	0.010	0.0006	0.0083	0.0050	0.0021	0.0009	0.0021	0.0006	0.0012
7/16	12	0.010	0.0007	0.0083	0.0050	0.0023	0.0010	0.0023	0.0007	0.0013
1/2	10	0.020	0.0007	0.0100	0.0050	0.0025	0.0011	0.0025	0.0007	0.0014
5/8	8	0.020	0.0008	0.0125	0.0062	0.0028	0.0012	0.0028	0.0008	0.0016
3/4	6	0.020	0.0009	0.0167	0.0083	0.0030	0.0013	0.0030	0.0009	0.0017
7/8	6	0.020	0.0009	0.0167	0.0083	0.0033	0.0014	0.0033	0.0009	0.0019
1	5	0.020	0.0010	0.0200	0.0100	0.0035	0.0015	0.0035	0.0010	0.0020
1 1/8	5	0.020	0.0011	0.0200	0.0100	0.0037	0.0016	0.0037	0.0011	0.0021
1 1/4	5	0.020	0.0011	0.0200	0.0100	0.0039	0.0017	0.0039	0.0011	0.0022
1 3/8	4	0.020	0.0012	0.0250	0.0125	0.0041	0.0018	0.0041	0.0012	0.0023
1 1/2	4	0.020	0.0012	0.0250	0.0125	0.0043	0.0018	0.0043	0.0012	0.0024
1 3/4	4	0.020	0.0013	0.0250	0.0125	0.0046	0.0020	0.0046	0.0013	0.0026
2	4	0.020	0.0014	0.0250	0.0125	0.0049	0.0021	0.0049	0.0014	0.0028
2 1/4	3	0.020	0.0015	0.0333	0.0167	0.0052	0.0022	0.0052	0.0015	0.0030
2 1/2	3	0.020	0.0016	0.0333	0.0167	0.0055	0.0024	0.0055	0.0016	0.0032
2 3/4	3	0.020	0.0017	0.0333	0.0167	0.0058	0.0025	0.0058	0.0017	0.0033
3	2	0.020	0.0017	0.0500	0.0250	0.0061	0.0026	0.0061	0.0017	0.0035
3 1/2	2	0.020	0.0019	0.0500	0.0250	0.0065	0.0028	0.0065	0.0019	0.0037
4	2	0.020	0.0020	0.0500	0.0250	0.0070	0.0030	0.0070	0.0020	0.0040
4 1/2	2	0.020	0.0021	0.0500	0.0250	0.0074	0.0032	0.0074	0.0021	0.0042
5	2	0.020	0.0022	0.0500	0.0250	0.0078	0.0034	0.0078	0.0022	0.0045

^a All other dimensions are given in inches. Intermediate pitches take the values of the next coarser pitch listed. Values for intermediate diameters should be calculated from the formulas in column headings, but ordinarily may be interpolated.

^b To avoid a complicated formula and still provide an adequate tolerance, the pitch factor is used as a basis, with the minimum tolerance set at 0.005 in.

^c Tolerance on minor diameter of all external threads is $1.5 \times$ pitch diameter tolerance.

^d The minimum clearance at the minor diameter between the internal and external thread is the sum of the values in columns 3 and 5.

^e The minimum clearance at the major diameter between the internal and external thread is equal to column 4.

Example, 1.750-6-ACME-4C-LH: Indicates the same thread left-hand.

Example, 2.875-0.4P-0.8L-ACME-3C (Two Start): Indicates a Centralizing Class 3C Acme thread with 2.875-inch major diameter, 0.4-inch pitch, 0.8-inch lead, double thread, right-hand.

Example, 2.500-0.3333P-0.6667L-ACME-4C (Two Start): Indicates a Centralizing Class 4C Acme thread with 2.500-inch nominal major diameter (basic major diameter 2.500 inches), 0.3333-inch pitch, 0.6667-inch lead, double thread, right-hand. The same thread left-hand would have LH at the end of the designation.

Acme Centralizing Threads—Alternative Series with Minor Diameter Centralizing Control.—When Acme centralizing threads are produced in single units or in very small quantities (and principally in sizes larger than the range of commercial taps and dies) where the manufacturing process employs cutting tools (such as lathe cutting), it may be economically advantageous and therefore desirable to have the centralizing control of the mating threads located at the *minor diameters*.

Particularly under the above-mentioned type of manufacturing, the two advantages cited for minor diameter centralizing control over centralizing control at the major diameters of the mating threads are: 1) Greater ease and faster checking of machined thread dimensions. It is much easier to measure the minor diameter (root) of the external thread and the mating minor diameter (crest or bore) of the internal thread than it is to determine the major diameter (root) of the internal thread and the major diameter (crest or turn) of the external thread; and 2) better manufacturing control of the machined size due to greater ease of checking.

In the event that minor diameter centralizing is necessary, recalculate all thread dimensions, reversing major and minor diameter allowances, tolerances, radii, and chamfer.

American National Standard Stub Acme Threads.—This American National Standard ASME/ANSI B1.8-1988 (R2006) provides a Stub Acme screw thread for those unusual applications where, due to mechanical or metallurgical considerations, a coarse-pitch thread of shallow depth is required. The fit of Stub Acme threads corresponds to the Class 2G General Purpose Acme thread in American National Standard ANSI B1.5-1988. For a fit having less backlash, the tolerances and allowances for Classes 3G or 4G General Purpose Acme threads may be used.

Thread Form: The thread form and basic formulas for Stub Acme threads are given on page 1827 and the basic dimensions in Table 13.

Allowances and Tolerances: The major and minor diameter allowances for Stub Acme threads are the same as those given for General Purpose Acme threads on page 1826.

Pitch diameter allowances for Stub Acme threads are the same as for Class 2G General Purpose Acme threads and are given in Table 4. Pitch diameter tolerances for Stub Acme threads are the same as for Class 2G General Purpose Acme threads given in Table 5.

Limiting Dimensions: Limiting dimensions of American Standard Stub Acme threads may be determined by using the formulas given in Table 14a, or directly from Table 14b. The diagram below shows the limits of size for Stub Acme threads.

Thread Series: A preferred series of diameters and pitches for General Purpose Acme threads (Table 15) is recommended for Stub Acme threads.

Stub Acme Thread Designations.—The method of designation for Standard Stub Acme threads is illustrated in the following examples: 0.500-20 Stub Acme indicates a ½-inch major diameter, 20 threads per inch, right hand, single thread, Standard Stub Acme thread. The designation 0.500-20 Stub Acme-LH indicates the same thread except that it is left hand.

Table 13. American National Standard Stub Acme Screw Thread Form — Basic Dimensions ASME/ANSI B1.8-1988 (R2006)

Thds. per Inch ^a <i>n</i>	Pitch, $P = 1/n$	Height of Thread (Basic), $0.3P$	Total Height of Thread, $0.3P + \frac{1}{2}$ allowance ^b	Thread Thickness (Basic), $P/2$	Width of Flat	
					Crest of Internal Thread (Basic), $0.4224P$	Root of Internal Thread, $0.4224P - 0.259 \times$ allowance ^b
16	0.06250	0.01875	0.0238	0.03125	0.0264	0.0238
14	0.07143	0.02143	0.0264	0.03571	0.0302	0.0276
12	0.08333	0.02500	0.0300	0.04167	0.0352	0.0326
10	0.10000	0.03000	0.0400	0.05000	0.0422	0.0370
9	0.11111	0.03333	0.0433	0.05556	0.0469	0.0417
8	0.12500	0.03750	0.0475	0.06250	0.0528	0.0476
7	0.14286	0.04285	0.0529	0.07143	0.0603	0.0551
6	0.16667	0.05000	0.0600	0.08333	0.0704	0.0652
5	0.20000	0.06000	0.0700	0.10000	0.0845	0.0793
4	0.25000	0.07500	0.0850	0.12500	0.1056	0.1004
3½	0.28571	0.08571	0.0957	0.14286	0.1207	0.1155
3	0.33333	0.10000	0.1100	0.16667	0.1408	0.1356
2½	0.40000	0.12000	0.1300	0.20000	0.1690	0.1638
2	0.50000	0.15000	0.1600	0.25000	0.2112	0.2060
1½	0.66667	0.20000	0.2100	0.33333	0.2816	0.2764
1⅓	0.75000	0.22500	0.2350	0.37500	0.3168	0.3116
1	1.00000	0.30000	0.3100	0.50000	0.4224	0.4172

^a All other dimensions in inches. See Fig. 1, page 1827.

^b Allowance is 0.020 inch for 10 or less threads per inch and 0.010 inch for more than 10 threads per inch.

Table 14a. American National Standard Stub Acme Single-Start Screw Threads — Formulas for Determining Diameters ASME/ANSI B1.8-1988 (R2006)

D = Basic Major Diameter and Nominal Size in Inches D_2 = Basic Pitch Diameter = $D - 0.3P$ D_1 = Basic Minor Diameter = $D - 0.6P$	
No.	External Threads (Screws)
1	Major Dia., Max = D .
2	Major Dia., Min. = D minus 0.05 P .
3	Pitch Dia., Max. = D_2 minus allowance from the appropriate Class 2G column, Table 4.
4	Pitch Dia., Min. = Pitch Dia., Max. (Formula 3) minus Class 2G tolerance from Table 5.
5	Minor Dia., Max. = D_1 minus 0.020 for 10 threads per inch and coarser and 0.010 for finer pitches.
6	Minor Dia., Min. = Minor Dia., Max. (Formula 5) minus Class 2G pitch diameter tolerance from Table 5.
Internal Threads (Nuts)	
7	Major Dia., Min. = D plus 0.020 for 10 threads per inch and coarser and 0.010 for finer pitches.
8	Major Dia., Max. = Major Dia., Min. (Formula 7) plus Class 2G pitch diameter tolerance from Table 5.
9	Pitch Dia., Min. = $D_2 = D - 0.3P$
10	Pitch Dia., Max. = Pitch Dia., Min. (Formula 9) plus Class 2G tolerance from Table 5.
11	Minor Dia., Min. = $D_1 = D - 0.6P$
12	Minor Dia., Max = Minor Dia., Min. (Formula 11) plus 0.05 P .

Table 14b. Limiting Dimensions for American National Standard Stub Acme Single-Start Screw Threads ASME/ANSI B1.8-1988 (R2006)

Nominal Diameter, D		$\frac{1}{4}$	$\frac{5}{16}$	$\frac{3}{8}$	$\frac{7}{16}$	$\frac{1}{2}$	$\frac{5}{8}$	$\frac{3}{4}$	$\frac{7}{8}$	1	$1\frac{1}{8}$	$1\frac{1}{4}$	$1\frac{3}{8}$
Threads per Inch ^a		16	14	12	12	10	8	6	6	5	5	5	4
Limiting Dimensions		External Threads											
Major Dia.	{ Max (D)	0.2500	0.3125	0.3750	0.4375	0.5000	0.6250	0.7500	0.8750	1.0000	1.1250	1.2500	1.3750
	Min	0.2469	0.3089	0.3708	0.4333	0.4950	0.6188	0.7417	0.8667	0.9900	1.1150	1.2400	1.3625
Pitch Dia.	{ Max	0.2272	0.2871	0.3451	0.4076	0.4643	0.5812	0.6931	0.8175	0.9320	1.0565	1.1811	1.2906
	Min	0.2167	0.2757	0.3328	0.3950	0.4506	0.5658	0.6757	0.7996	0.9126	1.0367	1.1610	1.2686
Minor Dia.	{ Max	0.2024	0.2597	0.3150	0.3775	0.4200	0.5300	0.6300	0.7550	0.8600	0.9850	1.1100	1.2050
	Min	0.1919	0.2483	0.3027	0.3649	0.4063	0.5146	0.6126	0.7371	0.8406	0.9652	1.0899	1.1830
Limiting Dimensions		Internal Threads											
Major Dia.	{ Min	0.2600	0.3225	0.3850	0.4475	0.5200	0.6450	0.7700	0.8950	1.0200	1.1450	1.2700	1.3950
	Max	0.2705	0.3339	0.3973	0.4601	0.5337	0.6604	0.7874	0.9129	1.0394	1.1648	1.2901	1.4170
Pitch Dia.	{ Min	0.2312	0.2911	0.3500	0.4125	0.4700	0.5875	0.7000	0.8250	0.9400	1.0650	1.1900	1.3000
	Max	0.2417	0.3025	0.3623	0.4251	0.4837	0.6029	0.7174	0.8429	0.9594	1.0848	1.2101	1.3220
Minor Dia.	{ Min	0.2125	0.2696	0.3250	0.3875	0.4400	0.5500	0.6500	0.7750	0.8800	1.0050	1.1300	1.2250
	Max	0.2156	0.2732	0.3292	0.3917	0.4450	0.5562	0.6583	0.7833	0.8900	1.0150	1.1400	1.2375
Nominal Diameter, D		$1\frac{1}{2}$	$1\frac{3}{4}$	2	$2\frac{1}{4}$	$2\frac{1}{2}$	$2\frac{3}{4}$	3	$3\frac{1}{2}$	4	$4\frac{1}{2}$	5	
Threads per Inch ^a		4	4	4	3	3	3	2	2	2	2	2	
Limiting Dimensions		External Threads											
Major Dia.	{ Max (D)	1.5000	1.7500	2.0000	2.2500	2.5000	2.7500	3.0000	3.5000	4.0000	4.5000	5.0000	
	Min	1.4875	1.7375	1.9875	2.2333	2.4833	2.7333	2.9750	3.4750	3.9750	4.4750	4.9750	
Pitch Dia.	{ Max	1.4152	1.6645	1.9137	2.1380	2.3874	2.6367	2.8360	3.3350	3.8340	4.3330	4.8319	
	Min	1.3929	1.6416	1.8902	2.1117	2.3606	2.6094	2.8044	3.3026	3.8008	4.2991	4.7973	
Minor Dia.	{ Max	1.3300	1.5800	1.8300	2.0300	2.2800	2.5300	2.6800	3.1800	3.6800	4.1800	4.6800	
	Min	1.3077	1.5571	1.8065	2.0037	2.2532	2.5027	2.6484	3.1476	3.6468	4.1461	4.6454	
Limiting Dimensions		Internal Threads											
Major Dia.	{ Min	1.5200	1.7700	2.0200	2.2700	2.5200	2.7700	3.0200	3.5200	4.0200	4.5200	5.0200	
	Max	1.5423	1.7929	2.0435	2.2963	2.5468	2.7973	3.0516	3.5524	4.0532	4.5539	5.0546	
Pitch Dia.	{ Min	1.4250	1.6750	1.9250	2.1500	2.4000	2.6500	2.8500	3.3500	3.8500	4.3500	4.8500	
	Max	1.4473	1.6979	1.9485	2.1763	2.4268	2.6773	2.8816	3.3824	3.8832	4.3839	4.8846	
Minor Dia.	{ Min	1.3500	1.6000	1.8500	2.0500	2.3000	2.5500	2.7000	3.2000	3.7000	4.2000	4.7000	
	Max	1.3625	1.6125	1.8625	2.0667	2.3167	2.5667	2.7250	3.2250	3.7250	4.2250	4.7250	

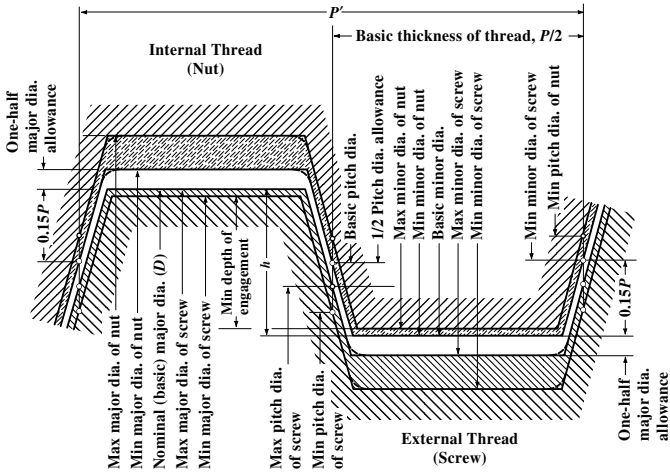

Limits of Size, Allowances, Tolerances, and Crest Clearances for American National Standard Stub Acme Threads

Alternative Stub Acme Threads.—Since one Stub Acme thread form may not meet the requirements of all applications, basic data for two of the other commonly used forms are included in the appendix of the American Standard for Stub Acme Threads. These so-called Modified Form 1 and Modified Form 2 threads utilize the same tolerances and allowances as Standard Stub Acme threads and have the same major diameter and basic thread thickness at the pitchline ($0.5P$). The basic height of Form 1 threads, h , is $0.375P$; for Form 2 it is $0.250P$. The basic width of flat at the crest of the internal thread is $0.4030P$ for Form 1 and $0.4353P$ for Form 2.

The pitch diameter and minor diameter for Form 1 threads will be smaller than similar values for the Standard Stub Acme Form and for Form 2 they will be larger owing to the differences in basic thread height h . Therefore, in calculating the dimensions of Form 1 and Form 2 threads using Formulas 1 through 12 in Table 14a, it is only necessary to substitute the following values in applying the formulas: For Form 1, $D_2 = D - 0.375P$, $D_1 = D - 0.75P$; for Form 2, $D_2 = D - 0.25P$, $D_1 = D - 0.5P$.

Thread Designation: These threads are designated in the same manner as Standard Stub Acme threads except for the insertion of either M1 or M2 after "Acme." Thus, 0.500-20 Stub Acme M1 for a Form 1 thread; and 0.500-20 Stub Acme M2 for a Form 2 thread.

Former 60-Degree Stub Thread.—Former American Standard B1.3-1941 included a 60-degree stub thread for use where design or operating conditions could be better satisfied by the use of this thread, or other modified threads, than by Acme threads. Data for 60-Degree Stub thread form are given in the accompanying diagram.

Table 15. Stub Acme Screw Thread Data ASME/ANSI B1.8-1988 (R2006)

Identification		Basic Diameters			Thread Data					
Nominal Sizes	Threads per Inch, ^a <i>n</i>	Major Diameter, <i>D</i>	Pitch Diameter, <i>D</i> ₂ = <i>D</i> - <i>h</i>	Minor Diameter, <i>D</i> ₁ = <i>D</i> - 2 <i>h</i>	Pitch, <i>P</i>	Thread Thickness at Pitch Line, <i>t</i> = <i>P</i> /2	Basic Thread Height, <i>h</i> = 0.3 <i>P</i>	Basic Width of Flat, 0.4224 <i>P</i>	Lead Anglet Basic Pitch Diameter	
									Deg	Min
1/4	16	0.2500	0.2312	0.2125	0.06250	0.03125	0.01875	0.0264	4	54
5/16	14	0.3125	0.2911	0.2696	0.07143	0.03572	0.02143	0.0302	4	28
3/8	12	0.3750	0.3500	0.3250	0.08333	0.04167	0.02500	0.0352	4	20
7/16	12	0.4375	0.4125	0.3875	0.08333	0.04167	0.02500	0.0352	3	41
1/2	10	0.5000	0.4700	0.4400	0.10000	0.05000	0.03000	0.0422	3	52
5/8	8	0.6250	0.5875	0.5500	0.12500	0.06250	0.03750	0.0528	3	52
3/4	6	0.7500	0.7000	0.6500	0.16667	0.08333	0.05000	0.0704	4	20
7/8	6	0.8750	0.8250	0.7750	0.16667	0.08333	0.05000	0.0704	3	41
1	5	1.0000	0.9400	0.8800	0.20000	0.10000	0.06000	0.0845	3	52
1 1/8	5	1.1250	1.0650	1.0050	0.20000	0.10000	0.06000	0.0845	3	25
1 1/4	5	1.2500	1.1900	1.1300	0.20000	0.10000	0.06000	0.0845	3	4
1 3/8	4	1.3750	1.3000	1.2250	0.25000	0.12500	0.07500	0.1056	3	30
1 1/2	4	1.5000	1.4250	1.3500	0.25000	0.12500	0.07500	0.1056	3	12
1 3/4	4	1.7500	1.6750	1.6000	0.25000	0.12500	0.07500	0.1056	2	43
2	4	2.0000	1.9250	1.8500	0.25000	0.12500	0.07500	0.1056	2	22
2 1/4	3	2.2500	2.1500	2.0500	0.33333	0.16667	0.10000	0.1408	2	50
2 1/2	3	2.5000	2.4000	2.3000	0.33333	0.16667	0.10000	0.1408	2	32
2 3/4	3	2.7500	2.6500	2.5500	0.33333	0.16667	0.10000	0.1408	2	18
3	2	3.0000	2.8500	2.7000	0.50000	0.25000	0.15000	0.2112	3	12
3 1/2	2	3.5000	3.3500	3.2000	0.50000	0.25000	0.15000	0.2112	2	43
4	2	4.0000	3.8500	3.7000	0.50000	0.25000	0.15000	0.2112	2	22
4 1/2	2	4.5000	4.3500	4.2000	0.50000	0.25000	0.15000	0.2112	2	6
5	2	5.0000	4.8500	4.7000	0.50000	0.25000	0.15000	0.2112	1	53

^a All other dimensions are given in inches.

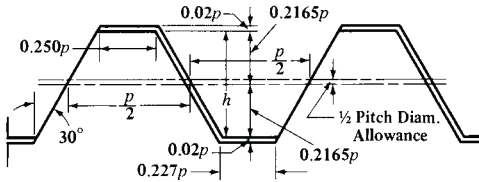

60-Degree Stub Thread

A clearance of at least $0.02 \times$ pitch is added to depth h to produce extra depth, thus avoiding interference with threads of mating part at minor or major diameters.

Basic thread thickness at pitch line = $0.5 \times$ pitch p ; basic depth $h = 0.433 \times$ pitch; basic width of flat at crest = $0.25 \times$ pitch; width of flat at root of screw thread = $0.227 \times$ pitch; basic pitch diameter = basic major diameter $- 0.433 \times$ pitch; basic minor diameter = basic major diameter $- 0.866 \times$ pitch.

Square Thread.—The square thread is so named because the section is square, the depth, in the case of a screw, being equal to the width or one-half the pitch. The thread groove in a square-threaded nut is made a little greater than one-half the pitch in order to provide a slight clearance for the screw; hence, the tools used for threading square-threaded taps are a little less in width at the point than one-half the pitch. The pitch of a square thread is usually twice the pitch of an American Standard thread of corresponding diameter. The square thread has been superseded quite largely by the Acme form which has several advantages. See *ACME SCREW THREADS*.

10-Degree Modified Square Thread: The included angle between the sides of the thread is 10 degrees (see accompanying diagram). The angle of 10 degrees results in a thread which is the practical equivalent of a "square thread," and yet is capable of economical production. Multiple thread milling cutters and ground thread taps should not be specified for modified square threads of the larger lead angles without consulting the cutting tool manufacturer.

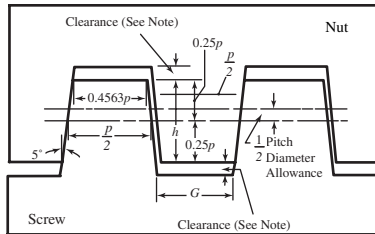

In the following formulas, D = basic major diameter; E = basic pitch diameter; K = basic minor diameter; p = pitch; h = basic depth of thread on screw depth when there is no clearance between root of screw and crest of thread on nut; t = basic thickness of thread at pitch line; F = basic width of flat at crest of screw thread; G = basic width of flat at root of screw thread; C = clearance between root of screw and crest of thread on nut; $E = D - 0.5p$; $K = D - p$; $h = 0.5p$ (see Note); $t = 0.5p$; $F = 0.4563p$; $G = 0.4563p - (0.17 \times C)$.

Note: A clearance should be added to depth h to avoid interference with threads of mating parts at minor or major diameters.

BUTTRESS THREADS

Threads of Buttress Form

The buttress form of thread has certain advantages in applications involving exceptionally high stresses along the thread axis in one direction only. The contacting flank of the thread, which takes the thrust, is referred to as the *pressure flank* and is so nearly perpendicular to the thread axis that the radial component of the thrust is reduced to a minimum. Because of the small radial thrust, this form of thread is particularly applicable where tubular members are screwed together, as in the case of breech mechanisms of large guns and airplane propeller hubs.

Fig. 1a shows a common form. The front or load-resisting face is perpendicular to the axis of the screw and the thread angle is 45 degrees. According to one rule, the pitch $P = 2 \times \text{screw diameter} \div 15$. The thread depth d may equal $\frac{3}{4} \times \text{pitch}$, making the flat $f = \frac{1}{8} \times \text{pitch}$. Sometimes depth d is reduced to $\frac{2}{3} \times \text{pitch}$, making $f = \frac{1}{6} \times \text{pitch}$.

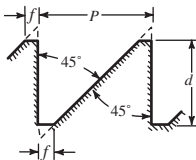

Fig. 1a.

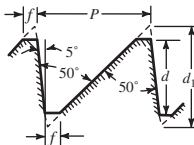

Fig. 1b.

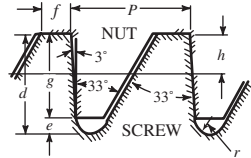

Fig. 1c.

The load-resisting side or flank may be inclined an amount (Fig. 1b) ranging usually from 1 to 5 degrees to avoid cutter interference in milling the thread. With an angle of 5 degrees and an included thread angle of 50 degrees, if the width of the flat f at both crest and root equals $\frac{1}{8} \times \text{pitch}$, then the thread depth equals $0.69 \times \text{pitch}$ or $\frac{3}{4} d_1$.

The saw-tooth form of thread illustrated by Fig. 1c is known in Germany as the "Sägengewinde" and in Italy as the "Fillettatura a dente di Sega." Pitches are standardized from 2 millimeters up to 48 millimeters in the German and Italian specifications. The front face inclines 3 degrees from the perpendicular and the included angle is 33 degrees.

The thread depth d for the screw = $0.86777 \times \text{pitch } P$. The thread depth g for the nut = $0.75 \times \text{pitch}$. Dimension $h = 0.341 \times P$. The width f of flat at the crest of the thread on the screw = $0.26384 \times \text{pitch}$. Radius r at the root = $0.12427 \times \text{pitch}$. The clearance space $e = 0.11777 \times \text{pitch}$.

British Standard Buttress Threads BS 1657: 1950.—Specifications for buttress threads in this standard are similar to those in the American Standard (see page 1851) except: 1) A basic depth of thread of $0.4p$ is used instead of $0.6p$; 2) Sizes below 1 inch are not included; 3) Tolerances on major and minor diameters are the same as the pitch diameter tolerances, whereas in the American Standard separate tolerances are provided; however, provision is made for smaller major and minor diameter tolerances when crest surfaces of screws or nuts are used as datum surfaces, or when the resulting reduction in depth of engagement must be limited; and 4) Certain combinations of large diameters with fine pitches are provided that are not encouraged in the American Standard.

Lowenherz or Löwenherz Thread.—The Lowenherz thread is intended for the fine screws of instruments and is based on the metric system. The Löwenherz thread has flats at the top and bottom the same as the U.S. standard buttress form, but the angle is 53 degrees 8 minutes. The depth equals $0.75 \times \text{pitch}$, and the width of the flats at the top and bottom is equal to $0.125 \times \text{pitch}$. This screw thread used for measuring instruments, optical apparatus, etc., especially in Germany.

Löwenherz Thread

Diameter		Pitch, Millimeters	Approximate No. of Threads per Inch	Diameter		Pitch, Millimeters	Approximate No. of Threads per Inch
Millimeters	Inches			Millimeters	Inches		
1.0	0.0394	0.25	101.6	9.0	0.3543	1.30	19.5
1.2	0.0472	0.25	101.6	10.0	0.3937	1.40	18.1
1.4	0.0551	0.30	84.7	12.0	0.4724	1.60	15.9
1.7	0.0669	0.35	72.6	14.0	0.5512	1.80	14.1
2.0	0.0787	0.40	63.5	16.0	0.6299	2.00	12.7
2.3	0.0905	0.40	63.5	18.0	0.7087	2.20	11.5
2.6	0.1024	0.45	56.4	20.0	0.7874	2.40	10.6
3.0	0.1181	0.50	50.8	22.0	0.8661	2.80	9.1
3.5	0.1378	0.60	42.3	24.0	0.9450	2.80	9.1
4.0	0.1575	0.70	36.3	26.0	1.0236	3.20	7.9
4.5	0.1772	0.75	33.9	28.0	1.1024	3.20	7.9
5.0	0.1968	0.80	31.7	30.0	1.1811	3.60	7.1
5.5	0.2165	0.90	28.2	32.0	1.2599	3.60	7.1
6.0	0.2362	1.00	25.4	36.0	1.4173	4.00	6.4
7.0	0.2756	1.10	23.1	40.0	1.5748	4.40	5.7
8.0	0.3150	1.20	21.1

American National Standard Buttress Inch Screw Threads

The buttress form of thread has certain advantages in applications involving exceptionally high stresses along the thread axis in one direction only. As the thrust side (load flank) of the standard buttress thread is made very nearly perpendicular to the thread axis, the radial component of the thrust is reduced to a minimum. On account of the small radial thrust, the buttress form of thread is particularly applicable when tubular members are screwed together. Examples of actual applications are the breech assemblies of large guns, airplane propeller hubs, and columns for hydraulic presses.

7°/45° Buttress Thread Form.—In selecting the form of thread recommended as standard, ANSI B1.9-1973 (R2007), manufacture by milling, grinding, rolling, or other suitable means, has been taken into consideration. All dimensions are in inches.

Form of Thread: The form of the buttress thread is shown in the accompanying Figs. 2a and 2b, and has the following characteristics:

- A load flank angle, measured in an axial plane, of 7 degrees from the normal to the axis.
- A clearance flank angle, measured in an axial plane, of 45 degrees from the normal to the axis.
- Equal truncations at the crests of the external and internal threads such that the basic height of thread engagement (assuming no allowance) is equal to 0.6 of the pitch
- Equal radii, at the roots of the external and internal basic thread forms tangential to the load flank and the clearance flank. (There is, in practice, almost no chance that the thread forms will be achieved strictly as basically specified, that is, as true radii.) When specified, equal flat roots of the external and internal thread may be supplied.

Table 1. American National Standard Diameter—Pitch Combinations for 7°/45° Buttress Threads ANSI B1.9-1973 (R2007)

Preferred Nominal Major Diameters, Inches	Threads per Inch ^a	Preferred Nominal Major Diameters, Inches	Threads per Inch ^a
0.5, 0.625, 0.75	(20, 16, 12)	4.5, 5, 5.5, 6	12, 10, 8, (6, 5, 4), 3
0.875, 1.0	(16, 12, 10)	7, 8, 9, 10	10, 8, 6, (5, 4, 3), 2.5, 2
1.25, 1.375, 1.5	16, (12, 10, 8), 6	11, 12, 14, 16	10, 8, 6, 5, (4, 3, 2.5), 2, 1.5, 1.25
1.75, 2, 2.25, 2.5	16, 12, (10, 8, 6), 5, 4	18, 20, 22, 24	8, 6, 5, 4, (3, 2.5, 2), 1.5, 1.25, 1
2.75, 3, 3.5, 4	16, 12, 10, (8, 6, 5), 4		

^aPreferred threads per inch are in parentheses.

**Table 2. American National Standard Inch Buttress Screw Threads—
Basic Dimensions ANSI B1.9-1973 (R2007)**

Thds. ^a per Inch	Pitch, p	Basic Height of Thread, $h = 0.6p$	Height of Sharp-V Thread, $H =$ $0.89064p$	Crest Truncation, $f =$ $0.14532p$	Height of Thread, h_s or $h_n =$ $0.66271p$	Max. Root Trunca- tion, ^b $s =$ $0.0826p$	Max. Root Radius, ^c $r =$ $0.0714p$	Width of Flat at Crest, $F =$ $0.16316p$
20	0.0500	0.0300	0.0445	0.0073	0.0331	0.0041	0.0036	0.0082
16	0.0625	0.0375	0.0557	0.0091	0.0414	0.0052	0.0045	0.0102
12	0.0833	0.0500	0.0742	0.0121	0.0552	0.0069	0.0059	0.0136
10	0.1000	0.0600	0.0891	0.0145	0.0663	0.0083	0.0071	0.0163
8	0.1250	0.0750	0.1113	0.0182	0.0828	0.0103	0.0089	0.0204
6	0.1667	0.1000	0.1484	0.0242	0.1105	0.0138	0.0119	0.0271
5	0.2000	0.1200	0.1781	0.0291	0.1325	0.0165	0.0143	0.0326
4	0.2500	0.1500	0.2227	0.0363	0.1657	0.0207	0.0179	0.0408
3	0.3333	0.2000	0.2969	0.0484	0.2209	0.0275	0.0238	0.0543
2½	0.4000	0.2400	0.3563	0.0581	0.2651	0.0330	0.0286	0.0653
2	0.5000	0.3000	0.4453	0.0727	0.3314	0.0413	0.0357	0.0816
1½	0.6667	0.4000	0.5938	0.0969	0.4418	0.0551	0.0476	0.1088
1¼	0.8000	0.4800	0.7125	0.1163	0.5302	0.0661	0.0572	0.1305
1	1.0000	0.6000	0.8906	0.1453	0.6627	0.0826	0.0714	0.1632

^a All other dimensions are in inches.^b Minimum root truncation is one-half of maximum.^c Minimum root radius is one-half of maximum.

Buttress Thread Tolerances.—Tolerances from basic size on external threads are applied in a minus direction and on internal threads in a plus direction.

Pitch Diameter Tolerances: The following formula is used for determining the pitch diameter product tolerance for Class 2 (standard grade) external or internal threads:

$$\text{PD tolerance} = 0.002 \sqrt[3]{D} + 0.00278 \sqrt{L_e} + 0.00854 \sqrt{p}$$

where D = basic major diameter of external thread (assuming no allowance)

L_e = length of engagement

p = pitch of thread

When the length of engagement is taken as $10p$, the formula reduces to

$$0.002 \sqrt[3]{D} + 0.0173 \sqrt{p}$$

It is to be noted that this formula relates specifically to Class 2 (standard grade) PD tolerances. Class 3 (precision grade) PD tolerances are two-thirds of Class 2 PD tolerances. Pitch diameter tolerances based on this latter formula, for various diameter pitch combinations, are given in [Table 4](#).

Functional Size: Deviations in lead and flank angle of product threads increase the functional size of an external thread and decrease the functional size of an internal thread by the cumulative effect of the diameter equivalents of these deviations. The functional size of all buttress product threads shall not exceed the maximum-material limit.

Tolerances on Major Diameter of External Thread and Minor Diameter of Internal Thread: Unless otherwise specified, these tolerances should be the same as the pitch diameter tolerance for the class used.

Tolerances on Minor Diameter of External Thread and Major Diameter of Internal Thread: It will be sufficient in most instances to state only the maximum minor diameter of the external thread and the minimum major diameter of the internal thread without any tol-

Form of American National Standard 7°/45° Buttress Thread with 0.6p Basic Height of Thread Engagement

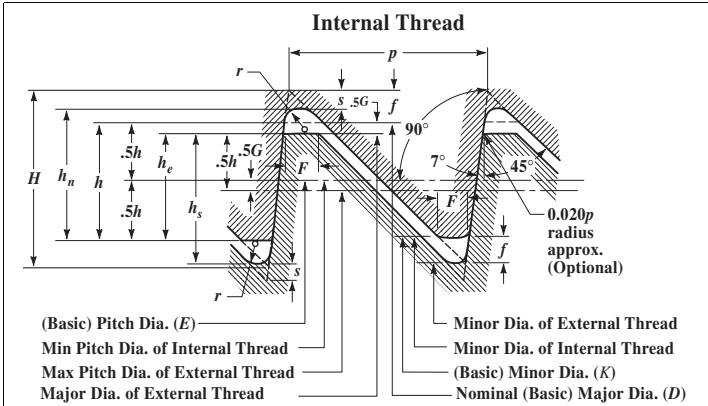

Fig. 2a. Round Root External Thread

Heavy Line Indicates Basic Form

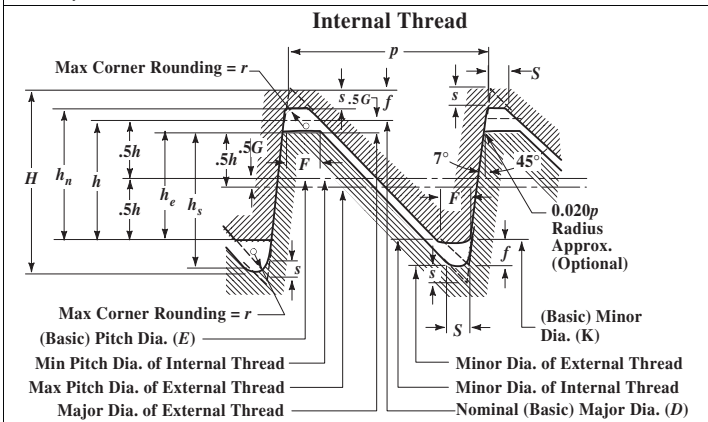

Fig. 2b. Flat Root External Thread

Heavy Line Indicates Basic Form

erance. However, the root truncation from a sharp V should not be greater than $0.0826p$ nor less than $0.0413p$.

Lead and Flank Angle Deviations for Class 2: The deviations in lead and flank angles may consume the entire tolerance zone between maximum and minimum material product limits given in Table 4.

Diameter Equivalents for Variations in Lead and Flank Angles for Class 3: The combined diameter equivalents of variations in lead (including helix deviations), and flank

Table 3. American National Standard Buttress Inch Screw Thread Symbols and Form

Thread Element	Max. Material (Basic)	Min. Material
Pitch	p	
Height of sharp-V thread	$H = 0.89064p$	
Basic height of thread engagement	$h = 0.6p$	
Root radius (theoretical)(see footnote ^a)	$r = 0.07141p$	Min. $r = 0.0357p$
Root truncation	$s = 0.0826p$	Min. $s = 0.5$; Max. $s = 0.0413p$
Root truncation for flat root form	$s = 0.0826p$	Min. $s = 0.5$; Max. $s = 0.0413p$
Flat width for flat root form	$S = 0.0928p$	Min. $S = 0.0464p$
Allowance	G (see text)	
Height of thread engagement	$h_e = h - 0.5G$	Min. $h_e = \text{Max. } h_e - [0.5 \text{ tol. on major dia. external thread} + 0.5 \text{ tol. on minor dia. internal thread}]$.
Crest truncation	$f = 0.14532p$	
Crest width	$F = 0.16316p$	
Major diameter	D	
Major diameter of internal thread	$D_n = D + 0.12542p$	Max. $D_n = \text{Max. pitch dia. of internal thread} + 0.80803p$
Major diameter of external thread	$D_s = D - G$	Min. $D_s = D - G - D \text{ tol.}$
Pitch diameter	E	
Pitch diameter of internal thread (see footnote ^b)	$E_n = D - h$	Max. $E_n = D - h + PD \text{ tol.}$
Pitch diameter of external thread (see footnote ^c)	$E_s = D - h - G$	Min. $E_s = D - h - G - PD \text{ tol.}$
Minor diameter	K	
Minor diameter of external thread	$K_s = D - 1.32542p - G$	Min. $K_s = \text{Min. pitch dia. of external thread} - 0.80803p$
Minor diameter of internal thread	$K_n = D - 2h$	Min. $K_n = D - 2h + K \text{ tol.}$
Height of thread of internal thread	$h_n = 0.66271p$	
Height of thread of external thread	$h_s = 0.66271p$	
Pitch diameter increment for lead	ΔEI	
Pitch diameter increment for 45° clearance flank angle	$\Delta E\alpha_1$	
Pitch diameter increment for 7° lead flank angle	$\Delta E\alpha_2$	
Length of engagement	L_e	

^a Unless the flat root form is specified, the rounded root form of the external and internal thread shall be a continuous, smoothly blended curve within the zone defined by $0.07141p$ maximum to $0.0357p$ minimum radius. The resulting curve shall have no reversals or sudden angular variations, and shall be tangent to the flanks of the thread. There is, in practice, almost no chance that the rounded thread form will be achieved strictly as basically specified, that is, as a true radius.

^b The pitch diameter X tolerances for GO and NOT GO threaded plug gages are applied to the internal product limits for E_n and Max. E_n .

^c The pitch diameter W tolerances for GO and NOT GO threaded setting plug gages are applied to the external product limits for E_s and Min. E_s .

Table 4. American National Standard Buttress Inch Screw Threads Tolerances Class 2 (Standard Grade) and Class 3 (Precision Grade) ANSI B1.9-1973 (R2007)

Thds. per Inch	Pitch, ^a <i>p</i> Inch	Basic Major Diameter, Inch										Pitch ^b Increment, $0.0173\sqrt{p}$ Inch
		From 0.5 thru 0.7	Over 0.7 thru 1.0	Over 1.0 thru 1.5	Over 1.5 thru 2.5	Over 2.5 thru 4	Over 4 thru 6	Over 6 thru 10	Over 10 thru 16	Over 16 thru 24		
		Tolerance on Major Diameter of External Thread, Pitch Diameter of External and Internal Threads, and Minor Diameter of Internal Thread, Inch										
Class 2, Standard Grade												
20	0.0500	.005600387
16	0.0625	.0060	.0062	.0065	.0068	.007300432
12	0.0833	.0067	.0069	.0071	.0075	.0080	.008400499
10	0.10000074	.0076	.0080	.0084	.0089	.0095	.010200547
8	0.12500083	.0086	.0091	.0095	.0101	.0108	.011500612
6	0.16670092	.0096	.0100	.0105	.0111	.0118	.012500706
5	0.20000103	.0107	.0112	.0117	.0124	.013200774
4	0.25000112	.0116	.0121	.0127	.0134	.014100865
3	0.33330134	.0140	.0147	.015400999
2.5	0.40000149	.0156	.0164	.016901094
2.0	0.50000162	.0169	.017701223
1.5	0.66670188	.019601413
1.25	0.80000202	.020901547
1.0	1.0000022701730
Diameter Increment, ^c $0.002\sqrt[3]{D}$.00169	.00189	.00215	.00252	.00296	.00342	.00400	.00470	.00543		
Class 3, Precision Grade												
20	0.0500	.0037	
16	0.0625	.0040	.0042	.0043	.0046	.0049	
12	0.0833	.0044	.0046	.0048	.0050	.0053	.0056	
10	0.10000049	.0051	.0053	.0056	.0059	.0063	.0068	
8	0.12500055	.0058	.0061	.0064	.0067	.0072	.0077	
6	0.16670061	.0064	.0067	.0070	.0074	.0078	.0083	
5	.020000068	.0071	.0074	.0078	.0083	.0088	
4	0.25000074	.0077	.0080	.0084	.0089	.0094	
3	.033330089	.0093	.0098	.0103	
2.5	0.40000100	.0104	.0109	
2.0	0.50000108	.0113	.0118	
1.5	0.66670126	.0130	
1.25	0.80000135	.0139	
1.0	1.00000152	

^aFor threads with pitches not shown in this table, pitch increment to be used in tolerance formula is to be determined by use of formula $PD \text{ Tolerance} = 0.002\sqrt[3]{D} + 0.00278\sqrt{L_e} + 0.00854\sqrt{p}$, where: *D* = basic major diameter of external thread (assuming no allowance), *L_e* = length of engagement, and *p* = pitch of thread. This formula relates specifically to Class 2 (standard grade) PD tolerances. Class 3 (precision grade) PD tolerances are two-thirds of Class 2 PD tolerances. See text

^bWhen the length of engagement is taken as 10*p*, the formula reduces to: $0.002\sqrt[3]{D} + 0.0173\sqrt{p}$

^cDiameter *D*, used in diameter increment formula, is based on the average of the range. angle for Class 3, shall not exceed 50 percent of the Class 2 pitch diameter tolerances given in Table 4.

Tolerances on Taper and Roundness: There are no requirements for taper and roundness for Class 2 buttress screw threads.

The major and minor diameters of Class 3 buttress threads shall not taper nor be out of round to the extent that specified limits for major and minor diameter are exceeded. The taper and out-of-roundness of the pitch diameter for Class 3 buttress threads shall not exceed 50 per cent of the pitch-diameter tolerances.

Allowances for Easy Assembly.—An allowance (clearance) should be provided on all external threads to secure easy assembly of parts. The amount of the allowance is deducted from the nominal major, pitch, and minor diameters of the external thread when the maximum material condition of the external thread is to be determined.

The minimum internal thread is basic.

The amount of the allowance is the same for both classes and is equal to the Class 3 pitch-diameter tolerance as calculated by the formulas previously given. The allowances for various diameter-pitch combinations are given in [Table 5](#).

Table 5. American National Standard External Thread Allowances for Classes 2 and 3 Buttress Inch Screw Threads ANSI B1.9-1973 (R2007)

Threads per Inch	Pitch, p Inch	Basic Major Diameter, Inch								
		From 0.5 thru 0.7	Over 0.7 thru 1.0	Over 1.0 thru 1.5	Over 1.5 thru 2.5	Over 2.5 thru 4	Over 4 thru 6	Over 6 thru 10	Over 10 thru 16	Over 16 thru 24
		Allowance on Major, Minor and Pitch Diameters of External Thread, Inch								
20	0.0500	.0037
16	0.0625	.0040	.0042	.0043	.0046	.0049
12	0.0833	.0044	.0046	.0048	.0050	.0053	.0056
10	0.10000049	.0051	.0053	.0056	.0059	.0063	.0068
8	0.12500055	.0058	.0061	.0064	.0067	.0072	.0077
6	0.16670061	.0064	.0067	.0070	.0074	.0078	.0083
5	0.20000068	.0071	.0074	.0078	.0083	.0088
4	0.25000074	.0077	.0080	.0084	.0089	.0094
3	0.33330089	.0093	.0098	.0103
2.5	0.40000100	.0104	.0109
2.0	0.50000108	.0113	.0118
1.5	0.66670126	.0130
1.25	0.80000135	.0139
1.0	1.00000152

Example Showing Dimensions for a Typical Buttress Thread.—The dimensions for a 2-inch diameter, 4 threads per inch, Class 2 buttress thread with flank angles of 7 degrees and 45 degrees are

$$h = \text{basic thread height} = 0.1500 \text{ (Table 2)}$$

$$h_s = h_n = \text{height of thread in external and internal threads} = 0.1657 \text{ (Table 2)}$$

$$G = \text{pitch-diameter allowance on external thread} = 0.0074 \text{ (Table 5)}$$

Tolerance on PD of external and internal threads = 0.0112 (Table 4)

Tolerance on major diameter of external thread and minor diameter of internal thread = 0.0112 (Table 4)

Internal Thread:

Basic Major Diameter: $D = 2.0000$

Min. Major Diameter: $D - 2h + 2h_n = 2.0314$ (see Table 2)

Min. Pitch Diameter: $D - h = 1.8500$ (see Table 2)

Max. Pitch Diameter: $D - h + \text{PD Tolerance} = 1.8612$ (see Table 4)

Min. Minor Diameter: $D - 2h = 1.7000$ (see Table 2)

Max. Minor Diameter: $D - 2h + \text{Minor Diameter Tolerance} = 1.7112$ (see Table 4)

External Thread:

Max. Major Diameter: $D - G = 1.9926$ (see Table 5)

Min. Major Diameter: $D - G - \text{Major Diameter Tolerance} = 1.9814$ (see Tables 4 and 5)

Max. Pitch Diameter: $D - h - G = 1.8426$ (see Tables 2 and 5)

Min. Pitch Diameter: $D - h - G - PD \text{ Tolerance} = 1.8314$ (see Table 4)

Max. Minor Diameter: $D - G - 2h_s = 1.6612$ (see Tables 2 and 5)

Buttress Thread Designations.—When only the designation, BUTT is used, the thread is “pull” type buttress (external thread pulls) with the clearance flank leading and the 7-degree pressure flank following. When the designation, PUSH-BUTT is used, the thread is a push type buttress (external thread pushes) with the 7-degree load flank leading and the 45-degree clearance flank following. Whenever possible this description should be confirmed by a simplified view showing thread angles on the drawing of the product that has the buttress thread.

Standard Buttress Threads: A buttress thread is considered to be standard when:

- 1) opposite flank angles are 7-degrees and 45-degrees; 2) basic thread height is $0.6p$;
- 3) tolerances and allowances are as shown in Tables 4 and 5; and 4) length of engagement is $10p$ or less.

Thread Designation Abbreviations: In thread designations on drawings, tools, gages, and in specifications, the following abbreviations and letters are to be used:

BUTT	for buttress thread, pull type
PUSH-BUTT	for buttress thread, push type
LH	for left-hand thread (Absence of LH indicates that the thread is a right-hand thread.)
P	for pitch
L	for lead
A	for external thread
B	for internal thread
Le	for length of thread engagement
SPL	for special
FL	for flat root thread
E	for pitch diameter
TPI	for threads per inch
THD	for thread

Note: Absence of A or B after thread class indicates that designation covers both the external and internal threads.

Designation Sequence for Buttress Inch Screw Threads.—When designating single-start standard buttress threads the nominal size is given first, the threads per inch next, then PUSH if the internal member is to push, but nothing if it is to pull, then the class of thread (2 or 3), then whether external (A) or internal (B), then LH if left-hand, but nothing if right-hand, and finally FL if a flat root thread, but nothing if a radiused root thread; thus, 2.5-8 BUTT-2A indicates a 2.5 inch, 8 threads per inch buttress thread, Class 2 external, right-hand, internal member to pull, with radiused root of thread. The designation 2.5-8 PUSH-BUTT-2A-LH-FL signifies a 2.5 inch size, 8 threads per inch buttress thread with internal member to push, Class 2 external, left-hand, and flat root.

A multiple-start standard buttress thread is similarly designated but the pitch is given instead of the threads per inch, followed by the lead and the number of starts is indicated in parentheses after the class of thread. Thus, 10-0.25P-0.5L - BUTT-3B (2 start) indicates a 10-inch thread with 4 threads per inch, 0.5 inch lead, buttress form with internal member to pull, Class 3 internal, 2 starts, with radiused root of thread.

WHITWORTH THREADS

British Standard Whitworth (BSW) and British Standard Fine (BSF) Threads

The BSW is the Coarse Thread series and the BSF is the Fine Thread series of British Standard 84:1956—Parallel Screw Threads of Whitworth Form. The dimensions given in the tables on the following pages for the major, effective, and minor diameters are, respectively, the maximum limits of these diameters for bolts and the minimum limits for nuts. Formulas for the tolerances on these diameters are given in the table below.

Whitworth Standard Thread Form.—This thread form is used for the British Standard Whitworth (BSW) and British Standard Fine (BSF) screw threads. More recently, both threads have been known as parallel screw threads of Whitworth form. With standardization of the Unified thread, the Whitworth thread form is expected to be used only for replacements or spare parts. Tables of British Standard Parallel Screw Threads of Whitworth Form will be found on the following pages; tolerance formulas are given in the table below. The form of the thread is shown by the diagram. If p = pitch, d = depth of thread, r = radius at crest and root, and n = number of threads per inch, then

$$d = \frac{1}{2}p \times \cot 27^{\circ} 30' = 0.640327p = 0.640327 \div n$$

$$r = 0.137329p = 0.137329 \div n$$

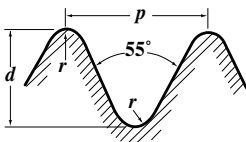

It is recommended that stainless steel bolts of nominal size $\frac{3}{4}$ inch and below should not be made to Close Class limits but rather to Medium or Free Class limits. Nominal sizes above $\frac{3}{4}$ inch should have maximum and minimum limits 0.001 inch smaller than the values obtained from the table.

Tolerance Classes : *Close Class bolts.* Applies to screw threads requiring a fine snug fit, and should be used only for special work where refined accuracy of pitch and thread form are particularly required. *Medium Class bolts and nuts.* Applies to the better class of ordinary interchangeable screw threads. *Free Class bolts.* Applies to the majority of bolts of ordinary commercial quality. *Normal Class nuts.* Applies to ordinary commercial quality nuts; this class is intended for use with Medium or Free Class bolts.

Table 1. Tolerance Formulas for BSW and BSF Threads

	Class or Fit	Tolerance in inches ^a (+ for nuts, - for bolts)		
		Major Dia.	Effective Dia.	Minor Dia.
Bolts	Close	$\frac{2}{3}T + 0.01\sqrt{p}$	$\frac{2}{3}T$	$\frac{2}{3}T + 0.013\sqrt{p}$
	Medium	$T + 0.01\sqrt{p}$	T	$T + 0.02\sqrt{p}$
	Free	$\frac{3}{2}T + 0.01\sqrt{p}$	$\frac{3}{2}T$	$\frac{3}{2}T + 0.02\sqrt{p}$
Nuts	Close	...	$\frac{2}{3}T$	} { 0.2p + 0.004 ^b 0.2p + 0.005 ^c 0.2p + 0.007 ^d
	Medium	...	T	
	Normal	...	$\frac{3}{2}T$	

^aThe symbol $T = 0.002\sqrt[3]{D} + 0.003\sqrt{L} + 0.005\sqrt{p}$, where D = major diameter of thread in inches; L = length of engagement in inches; p = pitch in inches. The symbol p signifies pitch.

^bFor 26 threads per inch and finer.

^cFor 24 and 22 threads per inch.

^dFor 20 threads per inch and coarser.

Table 2. Threads of Whitworth Form—Basic Dimensions

$p = 1 + n$
 $H = 0.960491p$
 $H/6 = 0.160082p$
 $h = 0.640327p$
 $e = 0.0739176p$
 $r = 0.137329p$

Threads per Inch	Pitch	Triangular Height	Shortening	Depth of Thread	Depth of Rounding	Radius
<i>n</i>	<i>p</i>	<i>H</i>	<i>H/6</i>	<i>h</i>	<i>e</i>	<i>r</i>
72	0.013889	0.013340	0.002223	0.008894	0.001027	0.001907
60	0.016667	0.016009	0.002668	0.010672	0.001232	0.002289
56	0.017857	0.017151	0.002859	0.011434	0.001320	0.002452
48	0.020833	0.020010	0.003335	0.013340	0.001540	0.002861
40	0.025000	0.024012	0.004002	0.016008	0.001848	0.003433
36	0.027778	0.026680	0.004447	0.017787	0.002053	0.003815
32	0.031250	0.030015	0.005003	0.020010	0.002310	0.004292
28	0.035714	0.034303	0.005717	0.022869	0.002640	0.004905
26	0.038462	0.036942	0.006157	0.024628	0.002843	0.005282
24	0.041667	0.040020	0.006670	0.026680	0.003080	0.005722
22	0.045455	0.043659	0.007276	0.029106	0.003366	0.006242
20	0.050000	0.048025	0.008004	0.032016	0.003696	0.006866
19	0.052632	0.050553	0.008425	0.033702	0.003890	0.007228
18	0.055556	0.053361	0.008893	0.035574	0.004107	0.007629
16	0.062500	0.060031	0.010005	0.040020	0.004620	0.008583
14	0.071429	0.068607	0.011434	0.045738	0.005280	0.009809
12	0.083333	0.080041	0.013340	0.053361	0.006160	0.011444
11	0.090909	0.087317	0.014553	0.058212	0.006720	0.012484
10	0.100000	0.096049	0.016008	0.064033	0.007392	0.013733
9	0.111111	0.106721	0.017787	0.071147	0.008213	0.015259
8	0.125000	0.120061	0.020010	0.080041	0.009240	0.017166
7	0.142857	0.137213	0.022869	0.091475	0.010560	0.019618
6	0.166667	0.160082	0.026680	0.106721	0.012320	0.022888
5	0.200000	0.192098	0.032016	0.128065	0.014784	0.027466
4.5	0.222222	0.213442	0.035574	0.142295	0.016426	0.030518
4	0.250000	0.240123	0.040020	0.160082	0.018479	0.034332
3.5	0.285714	0.274426	0.045738	0.182951	0.021119	0.039237
3.25	0.307692	0.295536	0.049256	0.197024	0.022744	0.042255
3	0.333333	0.320164	0.053361	0.213442	0.024639	0.045776
2.875	0.347826	0.334084	0.055681	0.222722	0.025710	0.047767
2.75	0.363636	0.349269	0.058212	0.232846	0.026879	0.049938
2.625	0.380952	0.365901	0.060984	0.243934	0.028159	0.052316
2.5	0.400000	0.384196	0.064033	0.256131	0.029567	0.054932

Dimensions are in inches.

Allowances: Only Free Class and Medium Class bolts have an allowance. For nominal sizes of 3/4 inch down to 1/4 inch, the allowance is 30 per cent of the Medium Class bolt effective-diameter tolerance (0.3T); for sizes less than 1/4 inch, the allowance for the 1/4-inch size applies. Allowances are applied minus from the basic bolt dimensions; the tolerances are then applied to the reduced dimensions.

Table 3. British Standard Whitworth (BSW) and British Standard Fine (BSF) Screw Thread Series—Basic Dimensions BS 84:1956 (obsolescent)

Nominal Size, Inches	Threads per Inch	Pitch, Inches	Depth of Thread, Inches	Major Diameter, Inches	Effective Diameter, Inches	Minor Diameter, Inches	Area at Bottom of Thread, Sq. in.	Tap Drill Dia.
Coarse Thread Series (BSW)								
$\frac{1}{8}$ ^a	40	0.02500	0.0160	0.1250	0.1090	0.9030	0.0068	2.55 mm
$\frac{3}{16}$	24	0.04167	0.0267	0.1875	0.1608	0.1341	0.0141	3.70 mm
$\frac{1}{4}$	20	0.05000	0.0320	0.2500	0.2180	0.1860	0.0272	5.10 mm
$\frac{5}{16}$	18	0.05556	0.0356	0.3125	0.2769	0.2413	0.0457	6.50 mm
$\frac{3}{8}$	16	0.06250	0.0400	0.3750	0.3350	0.2950	0.0683	9.30 mm
$\frac{7}{16}$	14	0.07143	0.0457	0.4375	0.3918	0.3461	0.0941	9.30 mm
$\frac{1}{2}$	12	0.08333	0.0534	0.5000	0.4466	0.3932	0.1214	10.50 mm
$\frac{9}{16}$ ^a	12	0.08333	0.0534	0.5625	0.5091	0.4557	0.1631	12.10 mm
$\frac{5}{8}$	11	0.09091	0.0582	0.6250	0.5668	0.5086	0.2032	13.50 mm
$1\frac{1}{16}$ ^a	11	0.09091	0.0582	0.6875	0.6293	0.5711	0.2562	15.00 mm
$\frac{3}{4}$	10	0.10000	0.0640	0.7500	0.6860	0.6220	0.3039	16.25 mm
$\frac{7}{8}$	9	0.11111	0.0711	0.8750	0.8039	0.7328	0.4218	19.25 mm
1	8	0.12500	0.0800	1.0000	0.9200	0.8400	0.5542	22.00 mm
$1\frac{1}{8}$	7	0.14286	0.0915	1.1250	1.0335	0.9420	0.6969	24.75 mm
$1\frac{1}{4}$	7	0.14286	0.0915	1.2500	1.1585	1.0670	0.8942	28.00 mm
$1\frac{1}{2}$	6	0.16667	0.1067	1.5000	1.3933	1.2866	1.3000	33.50 mm
$1\frac{3}{4}$	5	0.20000	0.1281	1.7500	1.6219	1.4938	1.7530	39.00 mm
2	4.5	0.22222	0.1423	2.0000	1.8577	1.7154	2.3110	44.50 mm
$2\frac{1}{4}$	4	0.25000	0.1601	2.2500	2.0899	1.9298	2.9250	
$2\frac{1}{2}$	4	0.25000	0.1601	2.5000	2.3399	2.1798	3.7320	
$2\frac{3}{4}$	3.5	0.28571	0.1830	2.7500	2.5670	2.3840	4.4640	
3	3.5	0.28571	0.1830	3.0000	2.8170	2.6340	5.4490	
$3\frac{1}{4}$ ^a	3.25	0.30769	0.1970	3.2500	3.0530	2.8560	6.4060	
$3\frac{1}{2}$ ^a	3.25	0.30769	0.1970	3.5000	3.3030	3.1060	7.5770	
$3\frac{3}{4}$ ^a	3	0.33333	0.2134	3.7500	3.5366	3.3232	8.6740	
4	3	0.33333	0.2134	4.0000	3.7866	3.5732	10.0300	
$4\frac{1}{2}$	2.875	0.34783	0.2227	4.5000	4.2773	4.0546	12.9100	
5	2.75	0.36364	0.2328	5.0000	4.7672	4.5344	16.1500	
$5\frac{1}{2}$	2.625	0.38095	0.2439	5.5000	5.2561	5.0122	19.7300	
6	2.5	0.40000	0.2561	6.0000	5.7439	5.4878	23.6500	
Fine Thread Series (BSF)								
$\frac{3}{16}$ ^{a,b}	32	0.03125	0.0200	0.1875	0.1675	0.1475	0.0171	4.00 mm
$\frac{7}{32}$ ^a	28	0.03571	0.0229	0.2188	0.1959	0.1730	0.0235	4.60 mm
$\frac{1}{4}$	26	0.03846	0.0246	0.2500	0.2254	0.2008	0.0317	5.30 mm
$\frac{9}{32}$ ^a	26	0.03846	0.0246	0.2812	0.2566	0.2320	0.0423	6.10 mm
$\frac{5}{16}$	22	0.04545	0.0291	0.3125	0.2834	0.2543	0.0508	6.80 mm
$\frac{3}{8}$	20	0.05000	0.0320	0.3750	0.3430	0.3110	0.0760	8.30 mm
$\frac{7}{16}$	18	0.05556	0.0356	0.4375	0.4019	0.3363	0.1054	9.30 mm
$\frac{1}{2}$	16	0.06250	0.0400	0.5000	0.4600	0.4200	0.1385	11.10 mm
$\frac{9}{16}$	16	0.06250	0.0400	0.5625	0.5225	0.4825	0.1828	12.70 mm
$\frac{5}{8}$	14	0.07143	0.0457	0.6250	0.5793	0.5336	0.2236	14.00 mm
$\frac{11}{16}$ ^a	14	0.07143	0.0457	0.6875	0.6418	0.5961	0.2791	15.50 mm
$\frac{3}{4}$	12	0.08333	0.0534	0.7500	0.6966	0.6432	0.3249	16.75 mm
$\frac{7}{8}$	11	0.09091	0.0582	0.8750	0.8168	0.7586	0.4520	19.75 mm
1	10	0.10000	0.0640	1.0000	0.9360	0.8720	0.5972	22.75 mm
$1\frac{1}{8}$	9	0.11111	0.0711	1.1250	1.0539	0.9828	0.7586	25.50 mm
$1\frac{1}{4}$	9	0.11111	0.0711	1.2500	1.1789	1.1078	0.9639	28.50 mm
$1\frac{3}{8}$ ^a	8	0.12500	0.0800	1.3750	1.2950	1.2150	1.1590	31.50 mm
$1\frac{1}{2}$	8	0.12500	0.0800	1.5000	1.4200	1.3400	1.4100	34.50 mm
$1\frac{5}{8}$ ^a	8	0.12500	0.0800	1.6250	1.5450	1.4650	1.6860	
$1\frac{3}{4}$	7	0.14286	0.0915	1.7500	1.6585	1.5670	1.9280	
2	7	0.14286	0.0915	2.0000	1.9085	1.8170	2.5930	
$2\frac{1}{4}$	6	0.16667	0.1067	2.2500	2.1433	2.0366	3.2580	
$2\frac{1}{2}$	6	0.16667	0.1067	2.5000	2.3933	2.2866	4.1060	
$2\frac{3}{4}$	6	0.16667	0.1067	2.7500	2.6433	2.5366	5.0540	
3	5	0.20000	0.1281	3.0000	2.8719	2.7438	5.9130	
$3\frac{1}{4}$	5	0.20000	0.1281	3.2500	3.1219	2.9938	7.0390	
$3\frac{1}{2}$	4.5	0.22222	0.1423	3.5000	3.3577	3.2154	8.1200	
$3\frac{3}{4}$	4.5	0.22222	0.1423	3.7500	3.6077	3.4654	9.4320	
4	4.5	0.22222	0.1423	4.0000	3.8577	3.7154	10.8400	
$4\frac{1}{4}$	4	0.25000	0.1601	4.2500	4.0899	3.9298	12.1300	

Tap drill diameters shown in this column are recommended sizes listed in BS 1157:1975 and provide from 77 to 87% of full thread.

Tap drill sizes listed in this column are recommended sizes shown in BS 1157:1975 and provide from 78 to 88% of full thread.

^aTo be dispensed with wherever possible.

^bThe use of number 2 BA threads is recommended in place of 3/16-inch BSF thread, see page 1886.

PIPE AND HOSE THREADS

The types of threads used on pipe and pipe fittings may be classed according to their intended use: 1) threads that when assembled with a sealer will produce a pressure-tight joint; 2) threads that when assembled without a sealer will produce a pressure-tight joint; 3) threads that provide free- and loose-fitting mechanical joints without pressure tightness; and 4) threads that produce rigid mechanical joints without pressure tightness.

American National Standard Pipe Threads

American National Standard pipe threads described in the following paragraphs provide taper and straight pipe threads for use in various combinations and with certain modifications to meet these specific needs.

Thread Designation and Notation.—American National Standard Pipe Threads are designated by specifying in sequence the nominal size, number of threads per inch, and the symbols for the thread series and form, as: $\frac{3}{8}$ —18 NPT. The symbol designations are as follows: NPT—American National Standard Taper Pipe Thread; NPTR—American National Standard Taper Pipe Thread for Railing Joints; NPSC—American National Standard Straight Pipe Thread for Couplings; NPSM—American National Standard Straight Pipe Thread for Free-fitting Mechanical Joints; NPSL—American National Standard Straight Pipe Thread for Loose-fitting Mechanical Joints with Locknuts; and NPSH—American National Standard Straight Pipe Thread for Hose Couplings.

American National Standard Taper Pipe Threads.—The basic dimensions of the ANSI Standard taper pipe thread are given in [Table 1a](#).

Form of Thread: The angle between the sides of the thread is 60 degrees when measured in an axial plane, and the line bisecting this angle is perpendicular to the axis. The depth of the truncated thread is based on factors entering into the manufacture of cutting tools and the making of tight joints and is given by the formulas in [Table 1a](#) or the data in [Table 2](#) obtained from these formulas. Although the standard shows flat surfaces at the crest and root of the thread, some rounding may occur in commercial practice, and it is intended that the pipe threads of product shall be acceptable when crest and root of the tools or chasers lie within the limits shown in [Table 2](#).

Pitch Diameter Formulas: In the following formulas, which apply to the ANSI Standard taper pipe thread, E_0 = pitch diameter at end of pipe; E_1 = pitch diameter at the large end of the internal thread and at the gaging notch; D = outside diameter of pipe; L_1 = length of hand-tight or normal engagement between external and internal threads; L_2 = basic length of effective external taper thread; and p = pitch = $1 \div$ number of threads per inch.

$$E_0 = D - (0.05D + 1.1)p$$

$$E_1 = E_0 + 0.0625L_1$$

Thread Length: The formula for L_2 determines the length of the effective thread and includes approximately two usable threads that are slightly imperfect at the crest. The normal length of engagement, L_1 , between external and internal taper threads, when assembled by hand, is controlled by the use of the gages.

$$L_2 = (0.80D + 6.8)p$$

Taper: The taper of the thread is 1 in 16, or 0.75 inch per foot, measured on the diameter and along the axis. The corresponding half-angle of taper or angle with the center line is 1 degree, 47 minutes.

Table 1a. Basic Dimensions, American National Standard Taper Pipe Threads, NPT
ANSI/ASME B1.20.1-1983 (R2006)

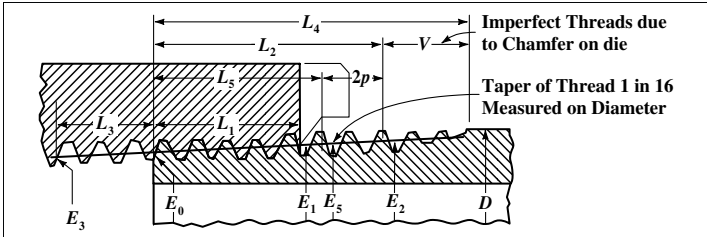

For all dimensions, see corresponding reference letter in table.

Angle between sides of thread is 60 degrees. Taper of thread, on diameter, is $\frac{3}{16}$ inch per foot. Angle of taper with center line is $1^\circ 47'$.

The basic maximum thread height, h , of the truncated thread is $0.8 \times$ pitch of thread. The crest and root are truncated a minimum of $0.033 \times$ pitch for all pitches. For maximum depth of truncation, see Table 2.

Nominal Pipe Size	Outside Dia. of Pipe, D	Threads per Inch, n	Pitch of Thread, p	Pitch Diameter at Beginning of External Thread, E_0	Handtight Engagement		Effective Thread, External	
					Length, ^a L_1	Dia., ^b E_1	Length, ^c L_2	Dia., E_2
					Inch		Inch	
$\frac{1}{16}$	0.3125	27	0.03704	0.27118	0.160	0.28118	0.2611	0.28750
$\frac{1}{8}$	0.405	27	0.03704	0.36351	0.1615	0.37360	0.2639	0.38000
$\frac{1}{4}$	0.540	18	0.05556	0.47739	0.2278	0.49163	0.4018	0.50250
$\frac{3}{8}$	0.675	18	0.05556	0.61201	0.240	0.62701	0.4078	0.63750
$\frac{1}{2}$	0.840	14	0.07143	0.75843	0.320	0.77843	0.5337	0.79179
$\frac{3}{4}$	1.050	14	0.07143	0.96768	0.339	0.98887	0.5457	1.00179
1	1.315	$11\frac{1}{2}$	0.08696	1.21363	0.400	1.23863	0.6828	1.25630
$1\frac{1}{4}$	1.660	$11\frac{1}{2}$	0.08696	1.55713	0.420	1.58338	0.7068	1.60130
$1\frac{1}{2}$	1.900	$11\frac{1}{2}$	0.08696	1.79609	0.420	1.82234	0.7235	1.84130
2	2.375	$11\frac{1}{2}$	0.08696	2.26902	0.436	2.29627	0.7565	2.31630
$2\frac{1}{2}$	2.875	8	0.12500	2.71953	0.682	2.76216	1.1375	2.79062
3	3.500	8	0.12500	3.34062	0.766	3.38850	1.2000	3.41562
$3\frac{1}{2}$	4.000	8	0.12500	3.83750	0.821	3.88881	1.2500	3.91562
4	4.500	8	0.12500	4.33438	0.844	4.38712	1.3000	4.41562
5	5.563	8	0.12500	5.39073	0.937	5.44929	1.4063	5.47862
6	6.625	8	0.12500	6.44609	0.958	6.50597	1.5125	6.54062
8	8.625	8	0.12500	8.43359	1.063	8.50003	1.7125	8.54062
10	10.750	8	0.12500	10.54531	1.210	10.62094	1.9250	10.66562
12	12.750	8	0.12500	12.53281	1.360	12.61781	2.1250	12.66562
14 OD	14.000	8	0.12500	13.77500	1.562	13.87262	2.2500	13.91562
16 OD	16.000	8	0.12500	15.76250	1.812	15.87575	2.4500	15.91562
18 OD	18.000	8	0.12500	17.75000	2.000	17.87500	2.6500	17.91562
20 OD	20.000	8	0.12500	19.73750	2.125	19.87031	2.8500	19.91562
24 OD	24.000	8	0.12500	23.71250	2.375	23.86094	3.2500	23.91562

^a Also length of thin ring gage and length from gaging notch to small end of plug gage.

^b Also pitch diameter at gaging notch (handtight plane).

^c Also length of plug gage.

**Table 1b. Basic Dimensions, American National Standard Taper Pipe Threads, NPT
 ANSI/ASME B1.20.1-1983 (R2006)**

Nominal Pipe Size	Wrench Makeup Length for Internal Thread		Vanish Thread, (3.47 thds.), <i>V</i>	Overall Length External Thread, <i>L</i> ₄	Nominal Perfect External Threads ^a		Height of Thread, <i>h</i>	Basic Minor Dia. at Small End of Pipe, ^b <i>K</i> ₀
	Length, ^c <i>L</i> ₃	Dia., <i>E</i> ₃			Length, <i>L</i> ₅	Dia., <i>E</i> ₅		
1/16	0.1111	0.26424	0.1285	0.3896	0.1870	0.28287	0.02963	0.2416
1/8	0.1111	0.35656	0.1285	0.3924	0.1898	0.37537	0.02963	0.3339
1/4	0.1667	0.46697	0.1928	0.5946	0.2907	0.49556	0.04444	0.4329
3/8	0.1667	0.60160	0.1928	0.6006	0.2967	0.63056	0.04444	0.5676
1/2	0.2143	0.74504	0.2478	0.7815	0.3909	0.78286	0.05714	0.7013
3/4	0.2143	0.95429	0.2478	0.7935	0.4029	0.99286	0.05714	0.9105
1	0.2609	1.19733	0.3017	0.9845	0.5089	1.24543	0.06957	1.1441
1 1/4	0.2609	1.54083	0.3017	1.0085	0.5329	1.59043	0.06957	1.4876
1 1/2	0.2609	1.77978	0.3017	1.0252	0.5496	1.83043	0.06957	1.7265
2	0.2609	2.25272	0.3017	1.0582	0.5826	2.30543	0.06957	2.1995
2 1/2	0.2500 ^d	2.70391	0.4337	1.5712	0.8875	2.77500	0.100000	2.6195
3	0.2500 ^d	3.32500	0.4337	1.6337	0.9500	3.40000	0.100000	3.2406
3 1/2	0.2500	3.82188	0.4337	1.6837	1.0000	3.90000	0.100000	3.7375
4	0.2500	4.31875	0.4337	1.7337	1.0500	4.40000	0.100000	4.2344
5	0.2500	5.37511	0.4337	1.8400	1.1563	5.46300	0.100000	5.2907
6	0.2500	6.43047	0.4337	1.9462	1.2625	6.52500	0.100000	6.3461
8	0.2500	8.41797	0.4337	2.1462	1.4625	8.52500	0.100000	8.3336
10	0.2500	10.52969	0.4337	2.3587	1.6750	10.65000	0.100000	10.4453
12	0.2500	12.51719	0.4337	2.5587	1.8750	12.65000	0.100000	12.4328
14 OD	0.2500	13.75938	0.4337	2.6837	2.0000	13.90000	0.100000	13.6750
16 OD	0.2500	15.74688	0.4337	2.8837	2.2000	15.90000	0.100000	15.6625
18 OD	0.2500	17.73438	0.4337	3.0837	2.4000	17.90000	0.100000	17.6500
20 OD	0.2500	19.72188	0.4337	3.2837	2.6000	19.90000	0.100000	19.6375
24 OD	0.2500	23.69688	0.4337	3.6837	3.0000	23.90000	0.100000	23.6125

^aThe length *L*₅ from the end of the pipe determines the plane beyond which the thread form is imperfect at the crest. The next two threads are perfect at the root. At this plane the cone formed by the crests of the thread intersects the cylinder forming the external surface of the pipe. *L*₅ = *L*₂ - 2*p*.

^bGiven as information for use in selecting tap drills.

^cThree threads for 2-inch size and smaller; two threads for larger sizes.

^dMilitary Specification MIL—P—7105 gives the wrench makeup as three threads for 3 in. and smaller. The *E*₃ dimensions are then as follows: Size 2 1/2 in., 2.69609 and size 3 in., 3.31719.

All dimensions given in inches.

Increase in diameter per thread is equal to 0.0625/*n*.

The basic dimensions of the ANSI Standard Taper Pipe Thread are given in inches to four or five decimal places. While this implies a greater degree of precision than is ordinarily attained, these dimensions are the basis of gage dimensions and are so expressed for the purpose of eliminating errors in computations.

Engagement Between External and Internal Taper Threads.—The normal length of engagement between external and internal taper threads when screwed together handtight is shown as *L*₁ in Table 1a. This length is controlled by the construction and use of the pipe thread gages. It is recognized that in special applications, such as flanges for high-pressure work, longer thread engagement is used, in which case the pitch diameter *E*₁ (Table 1a) is maintained and the pitch diameter *E*₀ at the end of the pipe is proportionately smaller.

Tolerances on Thread Elements.—The maximum allowable variation in the commercial product (manufacturing tolerance) is one turn large or small from the basic dimensions.

The permissible variations in thread elements on steel products and all pipe made of steel, wrought iron, or brass, exclusive of butt-weld pipe, are given in Table 3. This table is a

guide for establishing the limits of the thread elements of taps, dies, and thread chasers. These limits may be required on product threads.

On pipe fittings and valves (not steel) for steam pressures 300 pounds and below, it is intended that plug and ring gage practice as set up in the Standard ANSI/ASME B1.20.1 will provide for a satisfactory check of accumulated variations of taper, lead, and angle in such product. Therefore, no tolerances on thread elements have been established for this class.

For service conditions where a more exact check is required, procedures have been developed by industry to supplement the regulation plug and ring method of gaging.

Table 2. Limits on Crest and Root of American National Standard External and Internal Taper Pipe Threads, NPT ANSI/ASME B1.20.1-1983 (R2006)

INTERNAL THREAD							
EXTERNAL THREAD							
Threads per Inch	Height of Sharp V Thread, H	Height of Pipe Thread, h		Truncation, f		Width of Flat, F , Equivalent to Truncation	
		Max.	Min.	Min.	Max.	Min.	Max.
27	0.03208	0.02963	0.02496	0.0012	0.0036	0.0014	0.0041
18	0.04811	0.04444	0.03833	0.0018	0.0049	0.0021	0.0057
14	0.06186	0.05714	0.05071	0.0024	0.0056	0.0027	0.0064
11½	0.07531	0.06957	0.06261	0.0029	0.0063	0.0033	0.0073
8	0.10825	0.10000	0.09275	0.0041	0.0078	0.0048	0.0090

All dimensions are in inches and are given to four or five decimal places only to avoid errors in computations, not to indicate required precision.

Table 3. Tolerances on Taper, Lead, and Angle of Pipe Threads of Steel Products and All Pipe of Steel, Wrought Iron, or Brass ANSI/ASME B1.20.1-1983 (R2006) (Exclusive of Butt-Weld Pipe)

Nominal Pipe Size	Threads per Inch	Taper on Pitch Line ($\frac{3}{4}$ in./ft)		Lead in Length of Effective Threads	60 Degree Angle of Threads, Degrees
		Max.	Min.		
$\frac{1}{16}$ - $\frac{1}{8}$	27	$+\frac{1}{8}$	$-\frac{1}{16}$	± 0.003	$\pm 2\frac{1}{2}$
$\frac{1}{8}$ - $\frac{3}{8}$	18	$+\frac{1}{8}$	$-\frac{1}{16}$	± 0.003	± 2
$\frac{1}{2}$ - $\frac{3}{4}$	14	$+\frac{1}{8}$	$-\frac{1}{16}$	$\pm 0.003^a$	± 2
1, 1½, 2	11½	$+\frac{1}{8}$	$-\frac{1}{16}$	$\pm 0.003^a$	$\pm 1\frac{1}{2}$
2½ and larger	8	$+\frac{1}{8}$	$-\frac{1}{16}$	$\pm 0.003^a$	$\pm 1\frac{1}{2}$

^aThe tolerance on lead shall be ± 0.003 in. per inch on any size threaded to an effective thread length greater than 1 in.

For tolerances on height of thread, see [Table 2](#).

The limits specified in this table are intended to serve as a guide for establishing limits of the thread elements of taps, dies, and thread chasers. These limits may be required on product threads.

Table 4. Internal Threads in Pipe Couplings, NPSC for Pressure-tight Joints with Lubricant or Sealer ANSI/ASME B1.20.1-1983 (R2006)

Nom. Pipe- Size	Thds. per Inch	Minor ^a Dia.		Pitch Diameter ^b		Nom. Pipe Inch	Thds. per Inch	Minor ^a Dia.		Pitch Diameter ^b	
		Min.	Max.	Min.	Max.			Min.	Max.	Min.	Max.
$\frac{1}{8}$	27	0.340	0.3701	0.3771	1½	11½	1.745	1.8142	1.8305		
$\frac{1}{4}$	18	0.442	0.4864	0.4968	2	11½	2.219	2.2881	2.3044		
$\frac{3}{8}$	18	0.577	0.6218	0.6322	2½	8	2.650	2.7504	2.7739		
$\frac{1}{2}$	14	0.715	0.7717	0.7851	3	8	3.277	3.3768	3.4002		
$\frac{3}{4}$	14	0.925	0.9822	0.9956	3½	8	3.777	3.8771	3.9005		
1	11½	1.161	1.2305	1.2468	4	8	4.275	4.3754	4.3988		
1¼	11½	1.506	1.5752	1.5915		

^a As the ANSI Standard Pipe Thread form is maintained, the major and minor diameters of the internal thread vary with the pitch diameter. All dimensions are given in inches.

^b The actual pitch diameter of the straight tapped hole will be slightly smaller than the value given when gaged with a taper plug gage as called for in ANSI/ASME B1.20.1.

Railing Joint Taper Pipe Threads, NPTR.—Railing joints require a rigid mechanical thread joint with external and internal taper threads. The external thread is basically the same as the ANSI Standard Taper Pipe Thread, except that sizes $\frac{1}{2}$ through 2 inches are shortened by 3 threads and sizes $2\frac{1}{2}$ through 4 inches are shortened by 4 threads to permit the use of the larger end of the pipe thread. A recess in the fitting covers the last scratch or imperfect threads on the pipe.

Straight Pipe Threads in Pipe Couplings, NPSC.—Threads in pipe couplings made in accordance with the ANSI/ASME B1.20.1 specifications are straight (parallel) threads of the same thread form as the ANSI Standard Taper Pipe Thread. They are used to form pressure-tight joints when assembled with an ANSI Standard external taper pipe thread and made up with lubricant or sealant. These joints are recommended for comparatively low pressures only.

Straight Pipe Threads for Mechanical Joints, NPSM, NPSL, and NPSH.—While external and internal taper pipe threads are recommended for pipe joints in practically every service, there are mechanical joints where straight pipe threads are used to advantage. Three types covered by ANSI/ASME B1.20.1 are:

Loose-fitting Mechanical Joints With Locknuts (External and Internal), NPSL: This thread is designed to produce a pipe thread having the largest diameter that it is possible to cut on standard pipe. The dimensions of these threads are given in Table 5. It will be noted that the maximum major diameter of the external thread is slightly greater than the nominal outside diameter of the pipe. The normal manufacturer's variation in pipe diameter provides for this increase.

Loose-fitting Mechanical Joints for Hose Couplings (External and Internal), NPSH:

Hose coupling joints are ordinarily made with straight internal and external loose-fitting threads. There are several standards of hose threads having various diameters and pitches. One of these is based on the ANSI Standard pipe thread and by the use of this thread series, it is possible to join small hose couplings in sizes $\frac{1}{2}$ to 4 inches, inclusive, to ends of standard pipe having ANSI Standard External Pipe Threads, using a gasket to seal the joints. For the hose coupling thread dimensions see *ANSI Standard Hose Coupling Screw Threads* starting on page 1873.

Free-fitting Mechanical Joints for Fixtures (External and Internal), NPSM: Standard iron, steel, and brass pipe are often used for special applications where there are no internal pressures. Where straight thread joints are required for mechanical assemblies, straight pipe threads are often found more suitable or convenient. Dimensions of these threads are given in Table 5.

Table 5. American National Standard Straight Pipe Threads for Mechanical Joints, NPSM and NPSL ANSI/ASME B1.20.1-1983 (R2006)

Nominal Pipe Size	Threads per Inch	External Thread					Internal Thread			
		Allowance	Major Diameter		Pitch Diameter		Minor Diameter		Pitch Diameter	
			Max. ^a	Min.	Max.	Min.	Min. ^a	Max.	Min. ^b	Max.
Free-fitting Mechanical Joints for Fixtures—NPSM										
1/8	27	0.0011	0.397	0.390	0.3725	0.3689	0.358	0.364	0.3736	0.3783
1/4	18	0.0013	0.526	0.517	0.4903	0.4859	0.468	0.481	0.4916	0.4974
3/8	18	0.0014	0.662	0.653	0.6256	0.6211	0.603	0.612	0.6270	0.6329
1/2	14	0.0015	0.823	0.813	0.7769	0.7718	0.747	0.759	0.7784	0.7851
3/4	14	0.0016	1.034	1.024	0.9873	0.9820	0.958	0.970	0.9889	0.9958
1	11 1/2	0.0017	1.293	1.281	1.2369	1.2311	1.201	1.211	1.2386	1.2462
1 1/4	11 1/2	0.0018	1.638	1.626	1.5816	1.5756	1.546	1.555	1.5834	1.5912
1 1/2	11 1/2	0.0018	1.877	1.865	1.8205	1.8144	1.785	1.794	1.8223	1.8302
2	11 1/2	0.0019	2.351	2.339	2.2944	2.2882	2.259	2.268	2.2963	2.3044
2 1/2	8	0.0022	2.841	2.826	2.7600	2.7526	2.708	2.727	2.7622	2.7720
3	8	0.0023	3.467	3.452	3.3862	3.3786	3.334	3.353	3.3885	3.3984
3 1/2	8	0.0023	3.968	3.953	3.8865	3.8788	3.835	3.848	3.8888	3.8988
4	8	0.0023	4.466	4.451	4.3848	4.3771	4.333	4.346	4.3871	4.3971
5	8	0.0024	5.528	5.513	5.4469	5.4390	5.395	5.408	5.4493	5.4598
6	8	0.0024	6.585	6.570	6.5036	6.4955	6.452	6.464	6.5060	6.5165
Loose-fitting Mechanical Joints for Locknut Connections—NPSL										
1/8	27	...	0.409	...	0.3840	0.3805	0.362	...	0.3863	0.3898
1/4	18	...	0.541	...	0.5038	0.4986	0.470	...	0.5073	0.5125
3/8	18	...	0.678	...	0.6409	0.6357	0.607	...	0.6444	0.6496
1/2	14	...	0.844	...	0.7963	0.7896	0.753	...	0.8008	0.8075
3/4	14	...	1.054	...	1.0067	1.0000	0.964	...	1.0112	1.0179
1	11 1/2	...	1.318	...	1.2604	1.2523	1.208	...	1.2658	1.2739
1 1/4	11 1/2	...	1.663	...	1.6051	1.5970	1.553	...	1.6106	1.6187
1 1/2	11 1/2	...	1.902	...	1.8441	1.8360	1.792	...	1.8495	1.8576
2	11 1/2	...	2.376	...	2.3180	2.3099	2.265	...	2.3234	2.3315
2 1/2	8	...	2.877	...	2.7934	2.7817	2.718	...	2.8012	2.8129
3	8	...	3.503	...	3.4198	3.4081	3.344	...	3.4276	3.4393
3 1/2	8	...	4.003	...	3.9201	3.9084	3.845	...	3.9279	3.9396
4	8	...	4.502	...	4.4184	4.4067	4.343	...	4.4262	4.4379
5	8	...	5.564	...	5.4805	5.4688	5.405	...	5.4884	5.5001
6	8	...	6.620	...	6.5372	6.5255	6.462	...	6.5450	6.5567
8	8	...	8.615	...	8.5313	8.5196	8.456	...	8.5391	8.5508
10	8	...	10.735	...	10.6522	10.6405	10.577	...	10.6600	10.6717
12	8	...	12.732	...	12.6491	12.6374	12.574	...	12.6569	12.6686

^a As the ANSI Standard Straight Pipe Thread form of thread is maintained, the major and the minor diameters of the internal thread and the minor diameter of the external thread vary with the pitch diameter. The major diameter of the external thread is usually determined by the diameter of the pipe. These theoretical diameters result from adding the depth of the truncated thread ($0.666025 \times p$) to the maximum pitch diameters, and it should be understood that commercial pipe will not always have these maximum major diameters.

^b This is the same as the pitch diameter at end of internal thread, E_1 Basic. (See Table 1a.)

All dimensions are given in inches.

Notes for Free-fitting Fixture Threads: The minor diameters of external threads and major diameters of internal threads are those as produced by commercial straight pipe dies and commercial ground straight pipe taps.

The major diameter of the external thread has been calculated on the basis of a truncation of $0.10825p$, and the minor diameter of the internal thread has been calculated on the basis of a truncation of $0.21651p$, to provide no interference at crest and root when product is gaged with gages made in accordance with the Standard.

Notes for Loose-fitting Locknut Threads: The locknut thread is established on the basis of retaining the greatest possible amount of metal thickness between the bottom of the thread and the inside of the pipe. In order that a locknut may fit loosely on the externally threaded part, an allowance equal to the "increase in pitch diameter per turn" is provided, with a tolerance of $1\frac{1}{2}$ turns for both external and internal threads.

American National Standard Dryseal Pipe Threads for Pressure-Tight Joints.—

Dryseal pipe threads are based on the USA (American) pipe thread; however, they differ in that they are designed to seal pressure-tight joints without the necessity of using sealing compounds. To accomplish this, some modification of thread form and greater accuracy in manufacture is required. The roots of both the external and internal threads are truncated slightly more than the crests, i.e., roots have wider flats than crests so that metal-to-metal contact occurs at the crests and roots coincident with, or prior to, flank contact. Thus, as the threads are assembled by wrenching, the roots of the threads crush the sharper crests of the mating threads. This sealing action at both major and minor diameters tends to prevent spiral leakage and makes the joints pressure-tight without the necessity of using sealing compounds, provided that the threads are in accordance with standard specifications and tolerances and are not damaged by galling in assembly. The control of crest and root truncation is simplified by the use of properly designed threading tools. Also, it is desirable that both external and internal threads have full thread height for the length of hand engagement. Where not functionally objectionable, the use of a compatible lubricant or sealant is permissible to minimize the possibility of galling. This is desirable in assembling Dryseal pipe threads in refrigeration and other systems to effect a pressure-tight seal. The crest and root of Dryseal pipe threads may be slightly rounded, but are acceptable if they lie within the truncation limits given in Table 6.

Table 6. American National Standard Dryseal Pipe Threads—Limits on Crest and Root Truncation ANSI B1.20.3-1976 (R2003)

Threads Per Inch	Height of Sharp V Thread (H)	Truncation							
		Minimum				Maximum			
		At Crest		At Root		At Crest		At Root	
		Formula	Inch	Formula	Inch	Formula	Inch	Formula	Inch
27	0.03208	$0.047p$	0.0017	$0.094p$	0.0035	$0.094p$	0.0035	$0.140p$	0.0052
18	0.04811	$0.047p$	0.0026	$0.078p$	0.0043	$0.078p$	0.0043	$0.109p$	0.0061
14	0.06180	$0.036p$	0.0026	$0.060p$	0.0043	$0.060p$	0.0043	$0.085p$	0.0061
11½	0.07531	$0.040p$	0.0035	$0.060p$	0.0052	$0.060p$	0.0052	$0.090p$	0.0078
8	0.10825	$0.042p$	0.0052	$0.055p$	0.0069	$0.055p$	0.0069	$0.076p$	0.0095

All dimensions are given in inches. In the formulas, p = pitch.

Types of Dryseal Pipe Thread.—American National Standard ANSI B1.20.3-1976 (R2003) covers four types of standard Dryseal pipe threads:

NPTF, Dryseal USA (American) Standard Taper Pipe Thread

PTF-SAE SHORT, Dryseal SAE Short Taper Pipe Thread

NPSF, Dryseal USA (American) Standard Fuel Internal Straight Pipe Thread

NPSI, Dryseal USA (American) Standard Intermediate Internal Straight Pipe Thread

Table 7. Recommended Limitation of Assembly among the Various Types of Dryseal Threads

External Dryseal Thread		For Assembly with Internal Dryseal Thread	
Type	Description	Type	Description
1	NPTF (tapered), ext thd	1	NPTF (tapered), int thd
		2 ^{a,b}	PTF-SAE SHORT (tapered), int thd
		3 ^{a,c}	NPSF (straight), int thd
		4 ^{a,c,d}	NPSI (straight), int thd
2 ^{a,e}	PTF-SAE SHORT (tapered) ext thd	4	NPSI (straight), int thd
		1	NPTF (tapered), int thd

^a Pressure-tight joints without the use of a sealant can best be ensured where both components are threaded with NPTF (full length threads), since theoretically interference (sealing) occurs at all threads, but there are two less threads engaged than for NPTF assemblies. When straight internal threads are used, there is interference only at one thread depending on ductility of materials.

^b PTF-SAE SHORT internal threads are primarily intended for assembly with type 1-NPTF external threads. They are not designed for, and at extreme tolerance limits may not assemble with, type 2-PTF-SAE SHORT external threads.

^c There is no external straight Dryseal thread.

^d NPSI internal threads are primarily intended for assembly with type 2-PTF-SAE SHORT external threads but will also assemble with full length type 1 NPTF external threads.

^e PTF-SAE SHORT external threads are primarily intended for assembly with type 4-NPSI internal threads but can also be used with type 1-NPTF internal threads. They are not designed for, and at extreme tolerance limits may not assemble with, type 2-PTF-SAE SHORT internal threads or type 3-NPSF internal threads.

An assembly with straight internal pipe threads and taper external pipe threads is frequently more advantageous than an all taper thread assembly, particularly in automotive and other allied industries where economy and rapid production are major considerations. Dryseal threads are not used in assemblies in which both components have straight pipe threads.

NPTF Threads: This type applies to both external and internal threads and is suitable for pipe joints in practically every type of service. Of all Dryseal pipe threads, NPTF external and internal threads mated are generally conceded to be superior for strength and seal since they have the longest length of thread and, theoretically, interference (sealing) occurs at every engaged thread root and crest. Use of tapered internal threads, such as NPTF or PTF-SAE SHORT in hard or brittle materials having thin sections will minimize the possibility of fracture.

There are two classes of NPTF threads. Class 1 threads are made to interfere (seal) at root and crest when mated, but inspection of crest and root truncation is not required. Consequently, Class 1 threads are intended for applications where close control of tooling is required for conformance of truncation or where sealing is accomplished by means of a sealant applied to the threads.

Class 2 threads are theoretically identical to those made to Class 1, however, inspection of root and crest truncation is required. Consequently, where a sealant is not used, there is more assurance of a pressure-tight seal for Class 2 threads than for Class 1 threads.

PTF-SAE SHORT Threads: External threads of this type conform in all respects with NPTF threads except that the thread length has been shortened by eliminating one thread from the small (entering) end. These threads are designed for applications where clearance is not sufficient for the full length of the NPTF threads or for economy of material where the full thread length is not necessary.

Internal threads of this type conform in all respects with NPTF threads, except that the thread length has been shortened by eliminating one thread from the large (entry) end. These threads are designed for thin materials where thickness is not sufficient for the full thread length of the NPTF threads or for economy in tapping where the full thread length is not necessary.

Pressure-tight joints without the use of lubricant or sealer can best be ensured where mating components are both threaded with NPTF threads. This should be considered before specifying PTF-SAE SHORT external or internal threads.

NPSF Threads: Threads of this type are straight (cylindrical) instead of tapered and are internal only. They are more economical to produce than tapered internal threads, but when assembled do not offer as strong a guarantee of sealing since root and crest interference will not occur for all threads. NPSF threads are generally used with soft or ductile materials which will tend to adjust at assembly to the taper of external threads, but may be used in hard or brittle materials where the section is thick.

NPSI Threads: Threads of this type are straight (cylindrical) instead of tapered, are internal only and are slightly larger in diameter than NPSF threads but have the same tolerance and thread length. They are more economical to produce than tapered threads and may be used in hard or brittle materials where the section is thick or where there is little expansion at assembly with external taper threads. As with NPSF threads, NPSI threads when assembled do not offer as strong a guarantee of sealing as do tapered internal threads.

For more complete specifications for production and acceptance of Dryseal pipe threads, see ANSI B1.20.3 (Inch) and ANSI B1.20.4 (Metric Translation), and for gaging and inspection, see ANSI B1.20.5 (Inch) and ANSI B1.20.6M (Metric Translation).

Designation of Dryseal Pipe Threads: The standard Dryseal pipe threads are designated by specifying in sequence nominal size, thread series symbol, and class:

Examples: 1/8-27 NPTF-1; 1/8-27 PTF-SAE SHORT; and 3/8-18 NPTF-1 AFTER PLATING.

Table 8. Suggested Tap Drill Sizes for Internal Dryseal Pipe Threads

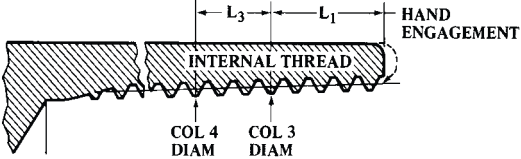

Size	Probable Drill Oversize Cut (Mean)	Taper Pipe Thread				Straight Pipe Thread		
		Minor Diameter At Distance		Drill Size ^a		Minor Diameter		
		L ₁ From Large End	L ₁ + L ₃ From Large End	Without Reamer	With Reamer	NPSF	NPSI	Drill Size ^a
1/16-27	0.0038	0.2443	0.2374	"C" (0.242)	"A" (0.234)	0.2482	0.2505	"D" (0.246)
1/8-27	0.0044	0.3367	0.3298	"Q" (0.332)	21/64 (0.328)	0.3406	0.3429	"R" (0.339)
1/4-18	0.0047	0.4362	0.4258	7/16 (0.438)	27/64 (0.422)	0.4422	0.4457	7/16 (0.438)
3/8-18	0.0049	0.5708	0.5604	9/16 (0.562)	9/16 (0.563)	0.5776	0.5811	37/64 (0.578)
1/2-14	0.0051	0.7034	0.6901	45/64 (0.703)	11/16 (0.688)	0.7133	0.7180	45/64 (0.703)
3/4-14	0.0060	0.9127	0.8993	29/32 (0.906)	57/64 (0.891)	0.9238	0.9283	59/64 (0.922)
1-11 1/2	0.0080	1.1470	1.1307	1 1/64 (1.141)	1 1/8 (1.125)	1.1600	1.1655	1 1/32 (1.156)
1 1/4-11 1/2	0.0100	1.4905	1.4742	1 31/64 (1.484)	1 15/32 (1.469)
1 1/2-11 1/2	0.0120	1.7295	1.7132	1 23/32 (1.719)	1 45/64 (1.703)
2-11 1/2	0.0160	2.2024	2.1861	2 3/16 (2.188)	2 11/64 (2.172)
2 1/2-8	0.0180	2.6234	2.6000	2 39/64 (2.609)	2 37/64 (2.578)
3-8	0.0200	3.2445	3.2211	3 15/64 (3.234)	3 13/64 (3.203)

^a Some drill sizes listed may not be standard drills.

All dimensions are given in inches.

Special Dryseal Threads.— Where design limitations, economy of material, permanent installation, or other limiting conditions prevail, consideration may be given to using a special Dryseal thread series.

Dryseal Special Short Taper Pipe Thread, PTF-SPL SHORT: Threads of this series conform in all respects to PTF-SAE SHORT threads except that the full thread length has been further shortened by eliminating one thread at the small end of internal threads or one thread at the large end of external threads.

Dryseal Special Extra Short Taper Pipe Thread, PTF-SPL EXTRA SHORT: Threads of this series conform in all respects to PTF-SAE SHORT threads except that the full thread length has been further shortened by eliminating two threads at the small end of internal threads or two threads at the large end of external threads.

Limitations of Assembly: Table 9 applies where Dryseal Special Short or Extra Short Taper Pipe Threads are to be assembled as special combinations.

Table 9. Assembly Limitations for Special Combinations of Dryseal Threads

Thread	May Assemble with ^a	May Assemble with ^b
PTF SPL SHORT EXTERNAL PTF SPL EXTRA SHORT EXTERNAL	PTF-SAE SHORT INTERNAL NPSF INTERNAL PTF SPL SHORT INTERNAL PTF SPL EXTRA SHORT INTERNAL	NPTF or NPSI INTERNAL
PTF SPL SHORT INTERNAL PTF SPL EXTRA SHORT INTERNAL	PTF-SAE SHORT EXTERNAL	NPTF EXTERNAL

^aOnly when the external thread or the internal thread or both are held closer than the standard tolerance, the external thread toward the minimum and the internal thread toward the maximum pitch diameter to provide a minimum of one turn hand engagement. At extreme tolerance limits the shortened full-thread lengths reduce hand engagement and the threads may not start to assemble.

^bOnly when the internal thread or the external thread or both are held closer than the standard tolerance, the internal thread toward the minimum and the external thread toward the maximum pitch diameter to provide a minimum of two turns for wrench make-up and sealing. At extreme tolerance limits the shortened full-thread lengths reduce wrench make-up and the threads may not seal.

Dryseal Fine Taper Thread Series, F-PTF: The need for finer pitches for nominal pipe sizes has brought into use applications of 27 threads per inch to $\frac{1}{4}$ - and $\frac{3}{8}$ -inch pipe sizes. There may be other needs that require finer pitches for larger pipe sizes. It is recommended that the existing threads per inch be applied to the next larger pipe size for a fine thread series, thus: $\frac{1}{4}$ -27, $\frac{3}{8}$ -27, $\frac{1}{2}$ -18, $\frac{3}{4}$ -18, 1-14, $1\frac{1}{4}$ -14, $1\frac{1}{2}$ -14, and 2-14. This series applies to external and internal threads of full length and is suitable for applications where threads finer than NPTF are required.

Dryseal Special Diameter-Pitch Combination Series, SPL-PTF: Other applications of diameter-pitch combinations have come into use where taper pipe threads are applied to nominal size thin wall tubing. These combinations are: $\frac{1}{2}$ -27, $\frac{5}{8}$ -27, $\frac{3}{4}$ -27, $\frac{7}{8}$ -27, and 1-27. This series applies to external and internal threads of full length and is applicable to thin wall nominal diameter outside tubing.

Designation of Special Dryseal Pipe Threads: The designations used for these special dryseal pipe threads are as follows:

$\frac{1}{8}$ -27 PTF-SPL SHORT

$\frac{1}{8}$ -27 PTF-SPL EXTRA SHORT

$\frac{1}{2}$ -27 SPL PTF, OD 0.500

Note that in the last designation the OD of tubing is given.

British Standard Pipe Threads

British Standard Pipe Threads for Non-pressure-tight Joints.—The threads in BS 2779:1973, "Specifications for Pipe Threads where Pressure-tight Joints are not Made on the Threads", are Whitworth form parallel fastening threads that are generally used for fastening purposes such as the mechanical assembly of component parts of fittings, cocks and valves. They are not suitable where pressure-tight joints are made on the threads.

The crests of the basic Whitworth thread form may be truncated to certain limits of size given in the Standard except on internal threads, when they are likely to be assembled with external threads conforming to the requirements of BS 21 "British Standard Pipe Threads for Pressure-tight Joints" (see page 1871).

For external threads two classes of tolerance are provided and for internal, one class. The two classes of tolerance for external threads are Class A and Class B. For economy of manufacture the class B fit should be chosen whenever possible. The class A is reserved for those applications where the closer tolerance is essential. Class A tolerance is an entirely negative value, equivalent to the internal thread tolerance. Class B tolerance is an entirely negative value twice that of class A tolerance. Tables showing limits and dimensions are given in the Standard.

The thread series specified in this Standard shall be designated by the letter "G". A typical reference on a drawing might be "G $\frac{1}{2}$ ", for internal thread; "G $\frac{1}{2}$ A", for external thread, class A; and "G $\frac{1}{2}$ B", for external thread, class B. Where no class reference is stated for external threads, that of class B will be assumed. The designation of truncated threads shall have the addition of the letter "T" to the designation, i.e., G $\frac{1}{2}$ T and G $\frac{1}{2}$ BT.

**British Standard Pipe Threads (Non-pressure-tight Joints)
Metric and Inch Basic Sizes BS 2779:1973**

Nominal Size, Inches	Threads per Inch ^a	Depth of Thread	Major Diameter	Pitch Diameter	Minor Diameter	Nominal Size, Inches	Threads per Inch ^a	Depth of Thread	Major Diameter	Pitch Diameter	Minor Diameter
$\frac{1}{16}$	28	0.581	7.723	7.142	6.561	$\frac{1}{4}$	11	1.479	53.746	52.267	50.788
		<i>0.0229</i>	<i>0.3041</i>	<i>0.2812</i>	<i>0.2583</i>			<i>0.0582</i>	<i>2.1160</i>	<i>2.0578</i>	<i>1.9996</i>
$\frac{1}{8}$	28	0.581	9.728	9.147	8.566	2	11	1.479	59.614	58.135	56.656
		<i>0.0229</i>	<i>0.3830</i>	<i>0.3601</i>	<i>0.3372</i>			<i>0.0582</i>	<i>2.3470</i>	<i>2.2888</i>	<i>2.2306</i>
$\frac{1}{4}$	19	0.856	13.157	12.301	11.445	$\frac{3}{4}$	11	1.479	65.710	64.231	62.752
		<i>0.0337</i>	<i>0.5180</i>	<i>0.4843</i>	<i>0.4506</i>			<i>0.0582</i>	<i>2.5870</i>	<i>2.5288</i>	<i>2.4706</i>
$\frac{3}{8}$	19	0.856	16.662	15.806	14.950	$2\frac{1}{2}$	11	1.479	75.184	73.705	72.226
		<i>0.0337</i>	<i>0.6560</i>	<i>0.6223</i>	<i>0.5886</i>			<i>0.0582</i>	<i>2.9600</i>	<i>2.9018</i>	<i>2.8436</i>
$\frac{1}{2}$	14	1.162	20.955	19.793	18.631	$3\frac{1}{4}$	11	1.479	81.534	80.055	78.576
		<i>0.0457</i>	<i>0.8250</i>	<i>0.7793</i>	<i>0.7336</i>			<i>0.0582</i>	<i>3.2100</i>	<i>3.1518</i>	<i>3.0936</i>
$\frac{5}{8}$	14	1.162	22.911	21.749	20.587	3	11	1.479	87.884	86.405	84.926
		<i>0.0457</i>	<i>0.9020</i>	<i>0.8563</i>	<i>0.8106</i>			<i>0.0582</i>	<i>3.4600</i>	<i>3.4018</i>	<i>3.3436</i>
$\frac{3}{4}$	14	1.162	26.441	25.279	24.117	$3\frac{1}{2}$	11	1.479	100.330	98.851	97.372
		<i>0.0457</i>	<i>1.0410</i>	<i>0.9953</i>	<i>0.9496</i>			<i>0.0582</i>	<i>3.9500</i>	<i>3.8918</i>	<i>3.8336</i>
$\frac{7}{8}$	14	1.162	30.201	29.039	27.877	4	11	1.479	113.030	111.551	110.072
		<i>0.0457</i>	<i>1.1890</i>	<i>1.1433</i>	<i>1.0976</i>			<i>0.0582</i>	<i>4.4500</i>	<i>4.3918</i>	<i>4.3336</i>
1	11	1.479	33.249	31.770	30.291	$4\frac{1}{2}$	11	1.479	125.730	124.251	122.772
		<i>0.0582</i>	<i>1.3090</i>	<i>1.2508</i>	<i>1.1926</i>			<i>0.0582</i>	<i>4.9500</i>	<i>4.8918</i>	<i>4.8336</i>
$1\frac{1}{8}$	11	1.479	37.897	36.418	34.939	5	11	1.479	138.430	136.951	135.472
		<i>0.0582</i>	<i>1.4920</i>	<i>1.4338</i>	<i>1.3756</i>			<i>0.0582</i>	<i>5.4500</i>	<i>5.3918</i>	<i>5.3336</i>
$1\frac{1}{4}$	11	1.479	41.910	40.431	38.952	$5\frac{1}{2}$	11	1.479	151.130	149.651	148.172
		<i>0.0582</i>	<i>1.6500</i>	<i>1.5918</i>	<i>1.5336</i>			<i>0.0582</i>	<i>5.9500</i>	<i>5.8918</i>	<i>5.8336</i>
$1\frac{1}{2}$	11	1.479	47.803	46.324	44.845	6	11	1.479	163.830	162.351	160.872
		<i>0.0582</i>	<i>1.8820</i>	<i>1.8238</i>	<i>1.7656</i>			<i>0.0582</i>	<i>6.4500</i>	<i>6.3918</i>	<i>6.3336</i>

^aThe thread pitches in millimeters are as follows: 0.907 for 28 threads per inch, 1.337 for 19 threads per inch, 1.814 for 14 threads per inch, and 2.309 for 11 threads per inch.

Each basic metric dimension is given in roman figures (nominal sizes excepted) and each basic inch dimension is shown in italics directly beneath it.

British Standard Pipe Threads for Pressure-tight Joints.—The threads in BS 21:1973, "Specification for Pipe Threads where Pressure-tight Joints are Made on the Threads", are based on the Whitworth thread form and are specified as:

1) *Jointing threads*: These relate to pipe threads for joints made pressure-tight by the mating of the threads; they include taper external threads for assembly with either taper or parallel internal threads (parallel external pipe threads are not suitable as jointing threads)

2) *Longscrew threads*: These relate to parallel external pipe threads used for longscrews (connectors) specified in BS 1387 where a pressure-tight joint is achieved by the compression of a soft material onto the surface of the external thread by tightening a back nut against a socket

**British Standard External and Internal Pipe Threads (Pressure-tight Joints)
Metric and Inch Dimensions and Limits of Size BS 21:1973**

Nominal Size	No. of Threads per Inch ^a		Basic Diameters at Gage Plane			Gage Length		Number of Useful Threads on Pipe for Basic Gage Length ^b	Tolerance + and -	
			Major	Pitch	Minor	Basic	Tolerance (+ and -)		Gage Plane to Face of Int. Taper Thread	On Diameter of Parallel Int. Threads
1/16	28	{	7.723	7.142	6.561	(4 ³ / ₈)	(1)	(7 ¹ / ₂)	(1 ¹ / ₂)	0.071
			<i>0.304</i>	<i>0.2812</i>	<i>0.2583</i>	4.0	0.9	6.5	1.1	<i>0.0028</i>
1/8	28	{	9.728	9.147	8.566	(4 ³ / ₈)	(1)	(7 ¹ / ₂)	(1 ¹ / ₂)	0.071
			<i>0.383</i>	<i>0.3601</i>	<i>0.3372</i>	4.0	0.9	6.5	1.1	<i>0.0028</i>
1/4	19	{	13.157	12.301	11.445	(4 ¹ / ₂)	(1)	(7 ¹ / ₂)	(1 ¹ / ₂)	0.104
			<i>0.518</i>	<i>0.4843</i>	<i>0.4506</i>	6.0	1.3	9.7	1.7	<i>0.0041</i>
3/8	19	{	16.662	15.806	14.950	(4 ³ / ₈)	(1)	(7 ¹ / ₂)	(1 ¹ / ₂)	0.104
			0.656	0.6223	0.5886	6.4	1.3	10.1	1.7	0.0041
1/2	14	{	20.955	19.793	18.631	(4 ¹ / ₂)	(1)	(7 ¹ / ₂)	(1 ¹ / ₂)	0.142
			<i>0.825</i>	<i>0.7793</i>	<i>0.7336</i>	8.2	1.8	13.2	2.3	<i>0.0056</i>
3/4	14	{	26.441	25.279	24.117	(5 ¹ / ₂)	(1)	(8)	(1 ¹ / ₂)	0.142
			<i>1.041</i>	<i>0.9953</i>	<i>0.9496</i>	9.5	1.8	14.5	2.3	<i>0.0056</i>
1	11	{	33.249	31.770	30.291	(4 ¹ / ₂)	(1)	(7 ¹ / ₂)	(1 ¹ / ₂)	0.180
			<i>1.309</i>	<i>1.2508</i>	<i>1.1926</i>	10.4	2.3	16.8	2.9	<i>0.0071</i>
1 1/4	11	{	41.910	40.431	38.952	(5 ¹ / ₂)	(1)	(8 ¹ / ₂)	(1 ¹ / ₂)	0.180
			<i>1.650</i>	<i>1.5918</i>	<i>1.5336</i>	12.7	2.3	19.1	2.9	<i>0.0071</i>
1 1/2	11	{	47.803	46.324	44.845	(5 ¹ / ₂)	(1)	(8 ¹ / ₂)	(1 ¹ / ₂)	0.180
			<i>1.882</i>	<i>1.8238</i>	<i>1.7656</i>	12.7	2.3	19.1	2.9	<i>0.0071</i>
2	11	{	59.614	58.135	56.656	(6 ⁷ / ₈)	(1)	(10 ¹ / ₂)	(1 ¹ / ₂)	0.180
			<i>2.347</i>	<i>2.2888</i>	<i>2.2306</i>	15.9	2.3	23.4	2.9	<i>0.0071</i>
2 1/2	11	{	75.184	73.705	72.226	(7 ⁹ / ₁₆)	(1 ¹ / ₂)	(11 ¹ / ₁₆)	(1 ¹ / ₂)	0.216
			<i>2.960</i>	<i>2.9018</i>	<i>2.8436</i>	17.5	3.5	26.7	3.5	<i>0.0085</i>
3	11	{	87.884	86.405	84.926	(8 ⁵ / ₁₆)	(1 ¹ / ₂)	(12 ⁵ / ₁₆)	(1 ¹ / ₂)	0.216
			<i>3.460</i>	<i>3.4018</i>	<i>3.3436</i>	20.6	3.5	29.8	3.5	<i>0.0085</i>
4	11	{	113.030	111.551	110.072	(11)	(1 ¹ / ₂)	(15 ¹ / ₂)	(1 ¹ / ₂)	0.216
			<i>4.450</i>	<i>4.3918</i>	<i>4.3336</i>	25.4	3.5	35.8	3.5	<i>0.0085</i>
5	11	{	138.430	136.951	135.472	(12 ³ / ₈)	(1 ¹ / ₂)	(17 ³ / ₈)	(1 ¹ / ₂)	0.216
			<i>5.450</i>	<i>5.3918</i>	<i>5.3336</i>	28.6	3.5	40.1	3.5	<i>0.0085</i>
6	11	{	163.830	162.351	160.872	(12 ³ / ₈)	(1 ¹ / ₂)	(17 ³ / ₈)	(1 ¹ / ₂)	0.216
			<i>6.450</i>	<i>6.3918</i>	<i>6.3336</i>	28.6	3.5	40.1	3.5	<i>0.0085</i>

^a In the Standard BS 21:1973 the thread pitches in millimeters are as follows: 0.907 for 28 threads per inch, 1.337 for 19 threads per inch, 1.814 for 14 threads per inch, and 2.309 for 11 threads per inch.

^b This is the minimum number of useful threads on the pipe for the basic gage length; for the maximum and minimum gage lengths, the minimum numbers of useful threads are, respectively, greater and less by the amount of tolerance in the column to the left. The design of internally threaded parts shall make allowance for receiving pipe ends of up to the minimum number of useful threads corresponding to the maximum gage length; the minimum number of useful *internal* threads shall be no less than 80 per cent of the minimum number of useful external threads for the minimum gage length.

Each basic metric dimension is given in roman figures (nominal sizes excepted) and each basic inch dimension is shown in italics directly beneath it. Figures in () are numbers of turns of thread with metric linear equivalents given beneath. Taper of taper thread is 1 in 16 on diameter.

Hose Coupling Screw Threads

ANSI Standard Hose Coupling Screw Threads.—Threads for hose couplings, valves, and all other fittings used in direct connection with hose intended for domestic, industrial, and general service in sizes $\frac{1}{2}$, $\frac{5}{8}$, $\frac{3}{4}$, 1, $1\frac{1}{4}$, $1\frac{1}{2}$, 2, $2\frac{1}{2}$, 3, $3\frac{1}{2}$, and 4 inches are covered by American National Standard ANSI/ASME B1.20.7-1991. These threads are designated as follows:

NH — Standard hose coupling threads of full form as produced by cutting or rolling.

NHR — Standard hose coupling threads for garden hose applications where the design utilizes thin walled material which is formed to the desired thread.

NPSH — Standard straight hose coupling thread series in sizes $\frac{1}{2}$ to 4 inches for joining to American National Standard taper pipe threads using a gasket to seal the joint.

Thread dimensions are given in Table 1 and thread lengths in Table 2.

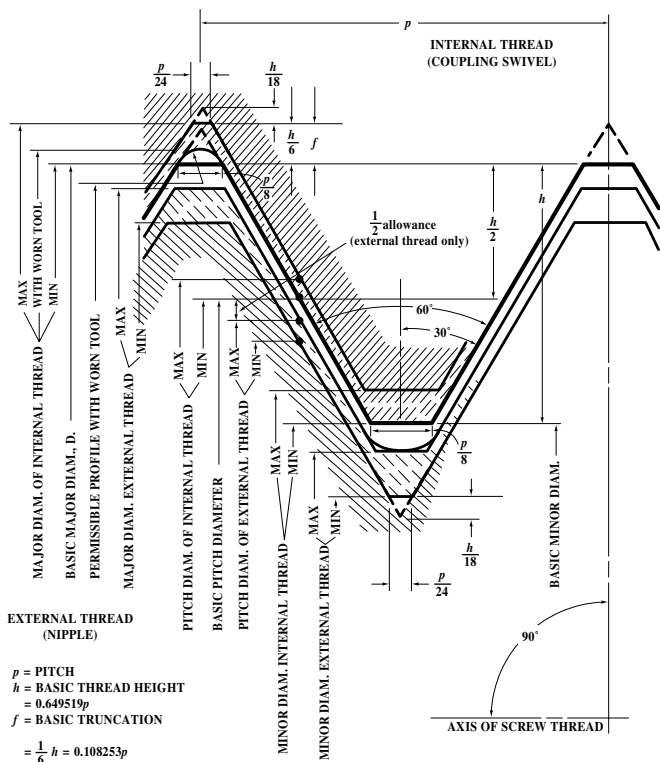

Fig. 1. Thread Form for ANSI Standard Hose Coupling Threads, NPSH, NH, and NHR. Heavy Line Shows Basic Size.

Table 1. ANSI Standard Hose Coupling Threads for NPSH, NH, and NHR Nipples and Coupling Swivels
ANSI/ASME B1.20.7-1991 (R2003)

Nominal Size of Hose	Threads per Inch	Thread Designation	Pitch	Basic Height of Thread	Nipple (External) Thread					Coupling (Internal) Thread				
					Major Dia.		Pitch Dia.		Minor Dia.	Minor Dia.		Pitch Dia.		Major Dia.
					Max.	Min.	Max.	Min.	Max.	Min.	Max.	Min.		
$\frac{1}{2}$ $\frac{3}{8}$ $\frac{3}{4}$	11.5	.75-11.5NH	.08696	.05648	1.0625	1.0455	1.0060	0.9975	0.9495	0.9595	0.9765	1.0160	1.0245	1.0725
$\frac{1}{2}$ $\frac{3}{8}$ $\frac{3}{4}$	11.5	.75-11.5NHR	.08696	.05648	1.0520	1.0350	1.0100	0.9930	0.9495	0.9720	0.9930	1.0160	1.0280	1.0680
$\frac{1}{2}$	14	.5-14NPSH	.07143	.04639	0.8248	0.8108	0.7784	0.7714	0.7320	0.7395	0.7535	0.7859	0.7929	0.8323
$\frac{3}{4}$	14	.75-14NPSH	.07143	.04639	1.0353	1.0213	0.9889	0.9819	0.9425	0.9500	0.9640	0.9964	1.0034	1.0428
1	11.5	1-11.5NPSH	.08696	.05648	1.2951	1.2781	1.2396	1.2301	1.1821	1.1921	1.2091	1.2486	1.2571	1.3051
$1\frac{1}{4}$	11.5	1.25-11.5NPSH	.08696	.05648	1.6399	1.6229	1.5834	1.5749	1.5269	1.5369	1.5539	1.5934	1.6019	1.6499
$1\frac{1}{2}$	11.5	1.5-11.5 NPSH	.08696	.05648	1.8788	1.8618	1.8223	1.8138	1.7658	1.7758	1.7928	1.8323	1.8408	1.8888
2	11.5	2-11.5NPSH	.08696	.05648	2.3528	2.3358	2.2963	2.2878	2.2398	2.2498	2.2668	2.3063	2.3148	2.3628
$2\frac{1}{2}$	8	2.5-8NPSH	.12500	.08119	2.8434	2.8212	2.7622	2.7511	2.6810	2.6930	2.7152	2.7742	2.7853	2.8554
3	8	3-8NPSH	.12500	.08119	3.4697	3.4475	3.3885	3.3774	3.3073	3.3193	3.3415	3.4005	3.4116	3.4817
$3\frac{1}{2}$	8	3.5-8NPSH	.12500	.08119	3.9700	3.9478	3.8888	3.8777	3.8076	3.8196	3.8418	3.9008	3.9119	3.9820
4	8	4-8NPSH	.12500	.08119	4.4683	4.4461	4.3871	4.3760	4.3059	4.3179	4.3401	4.3991	4.4102	4.4803
4	6	4-6NH (SPL)	.16667	.10825	4.9082	4.8722	4.7999	4.7819	4.6916	4.7117	4.7477	4.8200	4.8380	4.9283

All dimensions are given in inches.

Dimensions given for the maximum minor diameter of the nipple are figured to the intersection of the worn tool arc with a centerline through crest and root. The minimum minor diameter of the nipple shall be that corresponding to a flat at the minor diameter of the minimum nipple equal to $\frac{1}{2}p$, and may be determined by subtracting $0.7939p$ from the minimum pitch diameter of the nipple. (See Fig. 1)

Dimensions given for the minimum major diameter of the coupling correspond to the basic flat, $\frac{1}{2}p$, and the profile at the major diameter produced by a worn tool must not fall below the basic outline. The maximum major diameter of the coupling shall be that corresponding to a flat at the major diameter of the maximum coupling equal to $\frac{1}{2}p$ and may be determined by adding $0.7939p$ to the maximum pitch diameter of the coupling. (See Fig. 1)

NH and NHR threads are used for garden hose applications. NPSH threads are used for steam, air and all other hose connections to be made up with standard pipe threads. NH (SPL) threads are used for marine applications.

**Table 2. ANSI Standard Hose Coupling Screw Thread Lengths
 ANSI/ASME B1.20.7-1991 (R2003)**

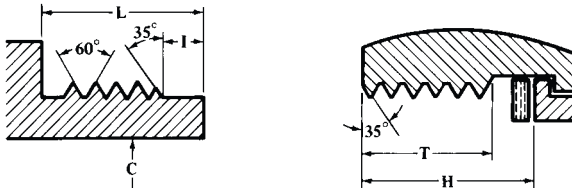

Nominal Size of Hose	Threads per Inch	I.D. of Nipple, C	Approx. O.D. of Ext. Thd.	Length of Nipple, L	Length of Pilot, I	Depth of Coupl., H	Coupl. Thd. Length, T	Approx. No. Thds. in Length T
1/2, 5/8, 3/4	11.5	25/32	1 1/16	9/16	1/8	17/32	3/8	4 1/4
1/2, 5/8, 3/4	11.5	25/32	1 1/16	9/16	1/8	17/32	3/8	4 1/4
1/2	14	17/32	13/16	1/2	1/8	15/32	5/16	4 1/4
3/4	14	25/32	1 1/32	9/16	1/8	17/32	3/8	5 1/4
1	11.5	1 1/32	1 9/32	9/16	5/32	17/32	3/8	4 1/4
1 1/4	11.5	1 9/32	1 5/8	5/8	5/32	19/32	15/32	5 1/2
1 1/2	11.5	1 17/32	1 7/8	5/8	5/32	19/32	15/32	5 1/2
2	11.5	2 1/32	2 11/32	3/4	3/16	23/32	19/32	6 3/4
2 1/2	8	2 17/32	2 27/32	1	1/4	15/16	11/16	5 1/2
3	8	3 1/32	3 15/32	1 1/8	1/4	1 1/16	13/16	6 1/2
3 1/2	8	3 17/32	3 31/32	1 1/8	1/4	1 1/16	13/16	6 1/2
4	8	4 1/32	4 15/32	1 1/8	1/4	1 1/16	13/16	6 1/2
4	6	4	4 29/32	1 1/8	5/16	1 1/16	3/4	4 1/2

All dimensions are given in inches. For thread designation see Table 1.

American National Fire Hose Connection Screw Thread.—This thread is specified in the National Fire Protection Association's Standard NFPA No. 194-1974. It covers the dimensions for screw thread connections for fire hose couplings, suction hose couplings, relay supply hose couplings, fire pump suction, discharge valves, fire hydrants, nozzles, adaptors, reducers, caps, plugs, wyes, siamese connections, standpipe connections, and sprinkler connections.

Form of Thread: The basic form of thread is as shown in Fig. 1. It has an included angle of 60 degrees and is truncated top and bottom. The flat at the root and crest of the basic thread form is equal to 1/8 (0.125) times the pitch in inches. The height of the thread is equal to 0.649519 times the pitch. The outer ends of both external and internal threads are terminated by the blunt start or "Higbee Cut" on full thread to avoid crossing and mutilation of thread.

Thread Designation: The thread is designated by specifying in sequence the nominal size of the connection, number of threads per inch followed by the thread symbol NH.

Thus, .75-8NH indicates a nominal size connection of 0.75 inch diameter with 8 threads per inch.

Basic Dimensions: The basic dimensions of the thread are as given in **Table 1**.

Table 1. Basic Dimensions of NH Threads NFPA 1963–1993 Edition

Nom. Size	Threads per Inch (tpi)	Thread Designation	Pitch, p	Basic Thread Height, h	Minimum Internal Thread Dimensions		
					Min. Minor Dia.	Basic Pitch Dia.	Basic Major Dia.
$\frac{3}{4}$	8	0.75-8 NH	0.12500	0.08119	1.2246	1.3058	1.3870
1	8	1-8 NH	0.12500	0.08119	1.2246	1.3058	1.3870
$1\frac{1}{2}$	9	1.5-9 NH	0.11111	0.07217	1.8577	1.9298	2.0020
$2\frac{1}{2}$	7.5	2.5-7.5 NH	0.13333	0.08660	2.9104	2.9970	3.0836
3	6	3-6 NH	0.16667	0.10825	3.4223	3.5306	3.6389
$3\frac{1}{2}$	6	3.5-6 NH	0.16667	0.10825	4.0473	4.1556	4.2639
4	4	4-4 NH	0.25000	0.16238	4.7111	4.8735	5.0359
$4\frac{1}{2}$	4	4.5-4 NH	0.25000	0.16238	5.4611	5.6235	5.7859
5	4	5-4 NH	0.25000	0.16238	5.9602	6.1226	6.2850
6	4	6-4 NH	0.25000	0.16238	6.7252	6.8876	7.0500
Nom. Size	Threads per Inch (tpi)	Thread Designation	Pitch, p	External Thread Dimensions (Nipple)			
				Allowance	Max. Major Dia.	Max. Pitch Dia.	Max. Minor Dia.
$\frac{3}{4}$	8	0.75-8 NH	0.12500	0.0120	1.3750	1.2938	1.2126
1	8	1-8 NH	0.12500	0.0120	1.3750	1.2938	1.2126
$1\frac{1}{2}$	9	1.5-9 NH	0.11111	0.0120	1.9900	1.9178	1.8457
$2\frac{1}{2}$	7.5	2.5-7.5 NH	0.13333	0.0150	3.0686	2.9820	2.8954
3	6	3-6 NH	0.16667	0.0150	3.6239	3.5156	3.4073
$3\frac{1}{2}$	6	3.5-6 NH	0.16667	0.0200	4.2439	4.1356	4.0273
4	4	4-4 NH	0.25000	0.0250	5.0109	4.8485	4.6861
$4\frac{1}{2}$	4	4.5-4 NH	0.25000	0.0250	5.7609	5.5985	5.4361
5	4	5-4 NH	0.25000	0.0250	6.2600	6.0976	5.9352
6	4	6-4 NH	0.25000	0.0250	7.0250	6.8626	6.7002

All dimensions are in inches.

Thread Limits of Size: Limits of size for NH external threads are given in **Table 2**. Limits of size for NH internal threads are given in **Table 3**.

Tolerances: The pitch-diameter tolerances for mating external and internal threads are the same. Pitch-diameter tolerances include lead and half-angle deviations. Lead deviations consuming one-half of the pitch-diameter tolerance are 0.0032 inch for $\frac{3}{4}$ -, 1-, and $1\frac{1}{2}$ -inch sizes; 0.0046 inch for $2\frac{1}{2}$ -inch size; 0.0052 inch for 3-, and $3\frac{1}{2}$ -inch sizes; and 0.0072 inch for 4-, $4\frac{1}{2}$ -, 5-, and 6-inch sizes. Half-angle deviations consuming one-half of the pitch-diameter tolerance are 1 degree, 42 minutes for $\frac{3}{4}$ - and 1-inch sizes; 1 degree, 54 minutes for $1\frac{1}{2}$ -inch size; 2 degrees, 17 minutes for $2\frac{1}{2}$ -inch size; 2 degrees, 4 minutes for 3- and $3\frac{1}{2}$ -inch size; and 1 degree, 55 minutes for 4-, $4\frac{1}{2}$ -, 5-, and 6-inch sizes.

Tolerances for the external threads are:

Major diameter tolerance = $2 \times$ pitch-diameter tolerance

Minor diameter tolerance = pitch-diameter tolerance + $2h/9$

The minimum minor diameter of the external thread is such as to result in a flat equal to one-third of the $p/8$ basic flat, or $p/24$, at the root when the pitch diameter of the external thread is at its minimum value. The maximum minor diameter is basic, but may be such as results from the use of a worn or rounded threading tool. The maximum minor diameter is shown in **Fig. 1** and is the diameter upon which the minor diameter tolerance formula shown above is based.

Tolerances for the internal threads are:

Minor diameter tolerance = $2 \times$ pitch-diameter tolerance

The minimum minor diameter of the internal thread is such as to result in a basic flat, $p/8$, at the crest when the pitch diameter of the thread is at its minimum value.

Major diameter tolerance = pitch-diameter tolerance - $2h/9$

Table 2. Limits of Size and Tolerances for NH External Threads (Nipples)
NFPA 1963, 1993 Edition

Nom. Size	Threads per Inch (tpi)	External Thread (Nipple)						
		Major Diameter			Pitch Diameter			Minor ^a Dia.
		Max.	Min.	Toler.	Max.	Min.	Toler.	Max.
$\frac{3}{4}$	8	1.3750	1.3528	0.0222	1.2938	1.2827	0.0111	1.2126
1	8	1.3750	1.3528	0.0222	1.2938	1.2827	0.0111	1.2126
$1\frac{1}{2}$	9	1.9900	1.9678	0.0222	1.9178	1.9067	0.0111	1.8457
$2\frac{1}{2}$	7.5	3.0686	3.0366	0.0320	2.9820	2.9660	0.0160	2.8954
3	6	3.6239	3.5879	0.0360	3.5156	3.4976	0.0180	3.4073
$3\frac{1}{2}$	6	4.2439	4.2079	0.0360	4.1356	4.1176	0.0180	4.0273
4	4	5.0109	4.9609	0.0500	4.8485	4.8235	0.0250	4.6861
$4\frac{1}{2}$	4	5.7609	5.7109	0.0500	5.5985	5.5735	0.0250	5.4361
5	4	6.2600	6.2100	0.0500	6.0976	6.0726	0.0250	5.9352
6	4	7.0250	6.9750	0.0500	6.8626	6.8376	0.0250	6.7002

^aDimensions given for the maximum minor diameter of the nipple are figured to the intersection of the worn tool arc with a center line through crest and root. The minimum minor diameter of the nipple shall be that corresponding to a flat at the minor diameter of the minimum nipple equal to $p/24$ and may be determined by subtracting $11h/9$ (or $0.7939p$) from the minimum pitch diameter of the nipple.

All dimensions are in inches.

Table 3. Limits of Size and Tolerances for NH Internal Threads (Couplings)
NFPA 1963, 1993 Edition

Nom. Size	Threads per Inch (tpi)	Internal Thread (Coupling)						
		Minor Diameter			Pitch Diameter			Major ^a Dia.
		Min.	Max.	Toler.	Min.	Max.	Toler.	Min.
$\frac{3}{4}$	8	1.2246	1.2468	0.0222	1.3058	1.3169	0.0111	1.3870
1	8	1.2246	1.2468	0.0222	1.3058	1.3169	0.0111	1.3870
$1\frac{1}{2}$	9	1.8577	1.8799	0.0222	1.9298	1.9409	0.0111	2.0020
$2\frac{1}{2}$	7.5	2.9104	2.9424	0.0320	2.9970	3.0130	0.0160	3.0836
3	6	3.4223	3.4583	0.0360	3.5306	3.5486	0.0180	3.6389
$3\frac{1}{2}$	6	4.0473	4.0833	0.0360	4.1556	4.1736	0.0180	4.2639
4	4	4.7111	4.7611	0.0500	4.8735	4.8985	0.0250	5.0359
$4\frac{1}{2}$	4	5.4611	5.5111	0.0500	5.6235	5.6485	0.0250	5.7859
5	4	5.9602	6.0102	0.0500	6.1226	6.1476	0.0250	6.2850
6	4	6.7252	6.7752	0.0500	6.8876	6.9126	0.0250	7.0500

^aDimensions for the minimum major diameter of the coupling correspond to the basic flat ($p/8$), and the profile at the major diameter produced by a worn tool must not fall below the basic outline. The maximum major diameter of the coupling shall be that corresponding to a flat at the major diameter of the maximum coupling equal to $p/24$ and may be determined by adding $11h/9$ (or $0.7939p$) to the maximum pitch diameter of the coupling.

All dimensions are in inches.

Gages and Gaging: Full information on gage dimensions and the use of gages in checking the NH thread are given in NFPA Standard No. 1963, 1993 Edition, published by the National Fire Protection Association, Batterymarch Park, Quincy, MA 02269.

The information and data taken from this standard are reproduced with the permission of the NFPA.

OTHER THREADS

Interference-Fit Threads

Interference-Fit Threads.—Interference-fit threads are threads in which the externally threaded member is larger than the internally threaded member when both members are in the free state and that, when assembled, become the same size and develop a holding torque through elastic compression, plastic movement of material, or both. By custom, these threads are designated Class 5.

The data in **Tables 1, 2, and 3**, which are based on years of research, testing and field study, represent an American standard for interference-fit threads that overcomes the difficulties experienced with previous interference-fit recommendations such as are given in Federal Screw Thread Handbook H28. These data were adopted as American Standard ASA B1.12-1963. Subsequently, the standard was revised and issued as American National Standard ANSI B1.12-1972. More recent research conducted by the Portsmouth Naval Shipyard has led to the current revision ASME/ANSI B1.12-1987 (R2003).

The data in **Tables 1, 2, and 3** provide dimensions for external and internal interference-fit (Class 5) threads of modified American National form in the Coarse Thread series, sizes $\frac{1}{4}$ inch to $1\frac{1}{2}$ inches. It is intended that interference-fit threads conforming with this standard will provide adequate torque conditions which fall within the limits shown in **Table 3**. The minimum torques are intended to be sufficient to ensure that externally threaded members will not loosen in service; the maximum torques establish a ceiling below which seizing, galling, or torsional failure of the externally threaded components is reduced.

Tables 1 and 2 give external and internal thread dimensions and are based on engagement lengths, external thread lengths, and tapping hole depths specified in **Table 3** and in compliance with the design and application data given in the following paragraphs. **Table 4** gives the allowances and **Table 5** gives the tolerances for pitch, major, and minor diameters for the Coarse Thread Series.

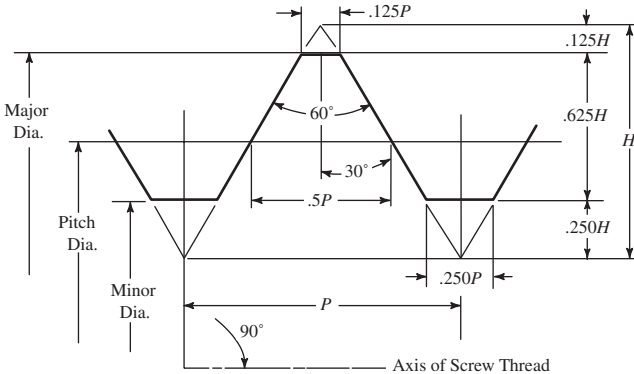

Basic Profile of American National Standard Class 5 Interference Fit Thread

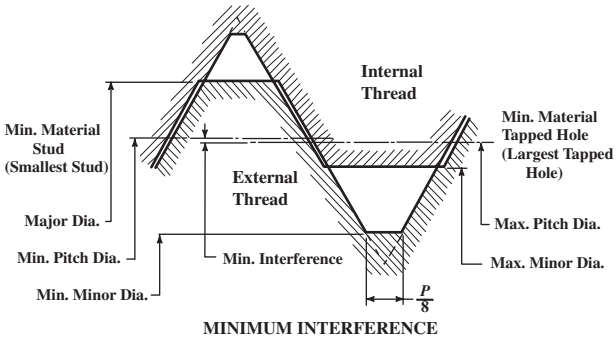
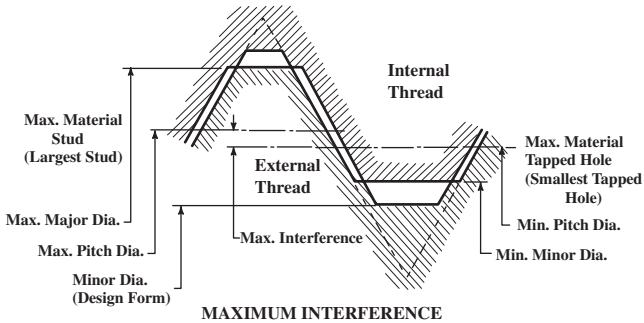

Note: Plastic flow of interference metal into cavities at major and minor diameters is not illustrated.

Maximum and Minimum Material Limits for Class 5 Interference-Fit Thread

Design and Application Data for Class 5 Interference-Fit Threads.—Following are conditions of usage and inspection on which satisfactory application of products made to dimensions in Tables 1, 2, and 3 are based.

Thread Designations: The following thread designations provide a means of distinguishing the American Standard Class 5 Threads from the tentative Class 5 and alternate Class 5 threads, specified in Handbook H28. They also distinguish between external and internal American Standard Class 5 Threads.

Class 5 External Threads are designated as follows:

NC-5 HF—For driving in hard ferrous material of hardness over 160 BHN.

NC-5 CSF—For driving in copper alloy and soft ferrous material of 160 BHN or less.

NC-5 ONF—For driving in other nonferrous material (nonferrous materials other than copper alloys), any hardness.

Class 5 Internal Threads are designated as follows:

NC-5 IF—Entire ferrous material range.

NC-5 INF—Entire nonferrous material range.

**Table 1. External Thread Dimensions for Class 5 Interference-Fit Threads
ANSI/ASME B1.12-1987 (R2003)**

Nominal Size	Major Diameter, Inches						Pitch Diameter, Inches		Minor Diameter, Inches
	NC-5 HF for driving in ferrous material with hardness greater than 160 BHN $L_e = 1\frac{1}{2}$ Diam.		NC-5 CSF for driving in brass and ferrous material with hardness equal to or less than 160 BHN $L_e = 1\frac{1}{2}$ Diam.		NC-5 ONF for driving in nonferrous except brass (any hardness) $L_e = 2\frac{1}{2}$ Diam.				
	Max	Min	Max	Min	Max	Min	Max	Min	
0.2500-20	0.2470	0.2418	0.2470	0.2418	0.2470	0.2418	0.2230	0.2204	0.1932
0.3125-18	0.3080	0.3020	0.3090	0.3030	0.3090	0.3030	0.2829	0.2799	0.2508
0.3750-16	0.3690	0.3626	0.3710	0.3646	0.3710	0.3646	0.3414	0.3382	0.3053
0.4375-14	0.4305	0.4233	0.4330	0.4258	0.4330	0.4258	0.3991	0.3955	0.3579
0.5000-13	0.4920	0.4846	0.4950	0.4876	0.4950	0.4876	0.4584	0.4547	0.4140
0.5625-12	0.5540	0.5460	0.5575	0.5495	0.5575	0.5495	0.5176	0.5136	0.4695
0.6250-11	0.6140	0.6056	0.6195	0.6111	0.6195	0.6111	0.5758	0.5716	0.5233
0.7500-10	0.7360	0.7270	0.7440	0.7350	0.7440	0.7350	0.6955	0.6910	0.6378
0.8750-9	0.8600	0.8502	0.8685	0.8587	0.8685	0.8587	0.8144	0.8095	0.7503
1.0000-8	0.9835	0.9727	0.9935	0.9827	0.9935	0.9827	0.9316	0.9262	0.8594
1.1250-7	1.1070	1.0952	1.1180	1.1062	1.1180	1.1062	1.0465	1.0406	0.9640
1.2500-7	1.2320	1.2200	1.2430	1.2312	1.2430	1.2312	1.1715	1.1656	1.0890
1.3750-6	1.3560	1.3410	1.3680	1.3538	1.3680	1.3538	1.2839	1.2768	1.1877
1.5000-6	1.4810	1.4670	1.4930	1.4788	1.4930	1.4788	1.4089	1.4018	1.3127

Based on external threaded members being steel ASTM A-325 (SAE Grade 5) or better. L_e = length of engagement.

**Table 2. Internal Thread Dimensions for Class 5 Interference-Fit Threads
ANSI/ASME B1.12-1987 (R2003)**

Nominal Size	NC-5 IF Ferrous Material			NC-5 INF Nonferrous Material			Pitch Diameter		Major Diam.
	Minor Diam. ^a		Tap Drill	Minor Diam. ^a		Tap Drill			
	Min	Max		Min	Max		Min	Max	
0.2500-20	0.196	0.206	0.2031	0.196	0.206	0.2031	0.2175	0.2201	0.2532
0.3125-18	0.252	0.263	0.2610	0.252	0.263	0.2610	0.2764	0.2794	0.3161
0.3750-16	0.307	0.318	0.3160	0.307	0.318	0.3160	0.3344	0.3376	0.3790
0.4375-14	0.374	0.381	0.3750	0.360	0.372	0.3680	0.3911	0.3947	0.4421
0.5000-13	0.431	0.440	0.4331	0.417	0.429	0.4219	0.4500	0.4537	0.5050
0.5625-12	0.488	0.497	0.4921	0.472	0.485	0.4844	0.5084	0.5124	0.5679
0.6250-11	0.544	0.554	0.5469	0.527	0.540	0.5313	0.5660	0.5702	0.6309
0.7500-10	0.667	0.678	0.6719	0.642	0.655	0.6496	0.6850	0.6895	0.7565
0.8750-9	0.777	0.789	0.7812	0.755	0.769	0.7656	0.8028	0.8077	0.8822
1.0000-8	0.890	0.904	0.8906	0.865	0.880	0.8750	0.9188	0.9242	1.0081
1.1250-7	1.000	1.015	1.0000	0.970	0.986	0.9844	1.0322	1.0381	1.1343
1.2500-7	1.125	1.140	1.1250	1.095	1.111	1.1094	1.1572	1.1631	1.2593
1.3750-6	1.229	1.247	1.2344	1.195	1.213	1.2031	1.2667	1.2738	1.3858
1.5000-6	1.354	1.372	1.3594	1.320	1.338	1.3281	1.3917	1.3988	1.5108

^aFourth decimal place is 0 for all sizes.

All dimensions are in inches, unless otherwise specified.

Externally Threaded Products: Points of externally threaded components should be chamfered or otherwise reduced to a diameter below the minimum minor diameter of the thread. The limits apply to bare or metallic coated parts. The threads should be free from excessive nicks, burrs, chips, grit or other extraneous material before driving.

Table 3. Torques, Interferences, and Engagement Lengths for Class 5 Interference-Fit Threads ANSI/ASME B1.12-1987 (R2003)

Nominal Size	Interference on Pitch Diameter		Engagement Lengths, External Thread Lengths and Tapped Hole Depths ^a						Torque at 1-1/2D Engagement in Ferrous Material	
			In Brass and Ferrous			In Nonferrous Except Brass				
	Max	Min	L_e	T_s	T_h min	L_e	T_s	T_h min	Max, lb-ft	Min, lb-ft
0.2500-20	.0055	.0003	0.312	0.375 + .125 - 0	0.375	0.625	0.688 + .125 - 0	0.688	12	3
0.3125-18	.0065	.0005	0.391	0.469 + .139 - 0	0.469	0.781	0.859 + .139 - 0	0.859	19	6
0.3750-16	.0070	.0006	0.469	0.562 + .156 - 0	0.562	0.938	1.031 + .156 - 0	1.031	35	10
0.4375-14	.0080	.0008	0.547	0.656 + .179 - 0	0.656	1.094	1.203 + .179 - 0	1.203	45	15
0.5000-13	.0084	.0010	0.625	0.750 + .192 - 0	0.750	1.250	1.375 + .192 - 0	1.375	75	20
0.5625-12	.0092	.0012	0.703	0.844 + .208 - 0	0.844	1.406	1.547 + .208 - 0	1.547	90	30
0.6250-11	.0098	.0014	0.781	0.938 + .227 - 0	0.938	1.562	1.719 + .227 - 0	1.719	120	37
0.7500-10	.0105	.0015	0.938	1.125 + .250 - 0	1.125	1.875	2.062 + .250 - 0	2.062	190	60
0.8750-9	.0016	.0018	1.094	1.312 + .278 - 0	1.312	2.188	2.406 + .278 - 0	2.406	250	90
1.0000-8	.0128	.0020	1.250	1.500 + .312 - 0	1.500	2.500	2.750 + .312 - 0	2.750	400	125
1.1250-7	.0143	.0025	1.406	1.688 + .357 - 0	1.688	2.812	3.094 + .357 - 0	3.095	470	155
1.2500-7	.0143	.0025	1.562	1.875 + .357 - 0	1.875	3.125	3.438 + .357 - 0	3.438	580	210
1.3750-6	.0172	.0030	1.719	2.062 + .419 - 0	2.062	3.438	3.781 + .419 - 0	3.781	705	250
1.5000-6	.0172	.0030	1.875	2.250 + .419 - 0	2.250	3.750	4.125 + .419 - 0	4.125	840	325

^a L_e = Length of engagement. T_s = External thread length of full form thread. T_h = Minimum depth of full form thread in hole.

All dimensions are inches.

Materials for Externally Threaded Products: The length of engagement, depth of thread engagement and pitch diameter in Tables 1, 2, and 3 are designed to produce adequate torque conditions when heat-treated medium-carbon steel products, ASTM A-325 (SAE Grade 5) or better, are used. In many applications, case-carburized and nonheat-treated medium-carbon steel products of SAE Grade 4 are satisfactory. SAE Grades 1 and 2, may be usable under certain conditions. This standard is not intended to cover the use of products made of stainless steel, silicon bronze, brass or similar materials. When such materials are used, the tabulated dimensions will probably require adjustment based on pilot experimental work with the materials involved.

Lubrication: For driving in ferrous material, a good lubricant sealer should be used, particularly in the hole. A non-carbonizing type of lubricant (such as a rubber-in-water dispersion) is suggested. The lubricant must be applied to the hole and it may be applied to the male member. In applying it to the hole, care must be taken so that an excess amount of lubricant will not cause the male member to be impeded by hydraulic pressure in a blind hole. Where sealing is involved, the lubricant selected should be insoluble in the medium being sealed.

For driving, in nonferrous material, lubrication may not be needed. The use of medium gear oil for driving in aluminum is recommended. American research has observed that the minor diameter of lubricated tapped holes in non-ferrous materials may tend to close in, that is, be reduced in driving; whereas with an unlubricated hole the minor diameter may tend to open up.

Driving Speed: This standard makes no recommendation for driving speed. Some opinion has been advanced that careful selection and control of driving speed is desirable to obtain optimum results with various combinations of surface hardness and roughness. Experience with threads made to this standard may indicate what limitations should be placed on driving speeds.

Table 4. Allowances for Coarse Thread Series ANSI/ASME B1.12-1987 (R2003)

TPI	Difference between Nom. Size and Max Major Diam of NC-5 HF ^a	Difference between Nom. Size and Max Major Diam. of NC-5 CSF or NC-5 ONF ^a	Difference between Basic Minor Diam. and Min Minor Diam. of NC-5 IF ^a	Difference between Basic Minor Diam. and Min Minor Diam. of NC-5 INF	Max PD Interference or Neg Allowance, Ext Thread ^b	Difference between Max Minor Diam. and Basic Minor Diam., Ext Thread
20	0.0030	0.0030	0.000	0.000	0.0055	0.0072
18	0.0045	0.0035	0.000	0.000	0.0065	0.0080
16	0.0060	0.0040	0.000	0.000	0.0070	0.0090
14	0.0070	0.0045	0.014	0.000	0.0080	0.0103
13	0.0080	0.0050	0.014	0.000	0.0084	0.0111
12	0.0085	0.0050	0.016	0.000	0.0092	0.0120
11	0.0110	0.0055	0.017	0.000	0.0098	0.0131
10	0.0140	0.0060	0.019	0.000	0.0105	0.0144
9	0.0150	0.0065	0.022	0.000	0.0116	0.0160
8	0.0165	0.0065	0.025	0.000	0.0128	0.0180
7	0.0180	0.0070	0.030	0.000	0.0143	0.0206
6	0.0190	0.0070	0.034	0.000	0.0172	0.0241

^a The allowances in these columns were obtained from industrial research data.

^b Negative allowance is the difference between the basic pitch diameter and pitch diameter value at maximum material condition.

All dimensions are in inches.

The difference between basic major diameter and internal thread minimum major diameter is $0.075H$ and is tabulated in Table 5.

Table 5. Tolerances for Pitch Diameter, Major Diameter, and Minor Diameter for Coarse Thread Series ANSI/ASME B1.12-1987 (R2003)

TPI	PD Tolerance for Ext and Int Threads ^a	Major Diam. Tolerance for Ext Thread ^b	Minor Diam. Tolerance for Int Thread NC-5 IF	Minor Diam. Tolerance for Int Thread NC-5 INF ^c	Tolerance $0.075H$ or $0.065P$ for Tap Major Diam.
20	0.0026	0.0052	0.010	0.010	0.0032
18	0.0030	0.0060	0.011	0.011	0.0036
16	0.0032	0.0064	0.011	0.011	0.0041
14	0.0036	0.0072	0.008	0.012	0.0046
13	0.0037	0.0074	0.008	0.012	0.0050
12	0.0040	0.0080	0.009	0.013	0.0054
11	0.0042	0.0084	0.010	0.013	0.0059
10	0.0045	0.0090	0.011	0.014	0.0065
9	0.0049	0.0098	0.012	0.014	0.0072
8	0.0054	0.0108	0.014	0.015	0.0093
7	0.0059	0.0118	0.015	0.015	0.0093
6	0.0071	0.0142	0.018	0.018	0.0108

^a National Class 3 pitch diameter tolerance from ASA B1.1-1960.

^b Twice the NC-3 pitch diameter tolerance.

^c National Class 3 minor diameter tolerance from ASA B1.1-1960.

All dimensions are in inches.

Relation of Driving Torque to Length of Engagement: Torques increase directly as the length of engagement and this increase is proportionately more rapid as size increases. The standard does not establish recommended breakloose torques.

Surface Roughness: Surface roughness is not a required measurement. Roughness between 63 and 125 μin . Ra is recommended. Surface roughness greater than 125 μin . Ra may encourage galling and tearing of threads. Surfaces with roughness less than 63 μin . Ra may hold insufficient lubricant and wring or weld together.

Lead and Angle Variations: The lead variation values tabulated in Table 6 are the maximum variations from specified lead between any two points not farther apart than the length of the standard GO thread gage. Flank angle variation values tabulated in Table 7 are maximum variations from the basic 30° angle between thread flanks and perpendiculars to the thread axis. The application of these data in accordance with ANSI/ASME B1.3M, the screw thread gaging system for dimensional acceptability, is given in the Standard. Lead variation does not change the volume of displaced metal, but it exerts a cumulative unilateral stress on the pressure side of the thread flank. Control of the difference between pitch diameter size and functional diameter size to within one-half the pitch diameter tolerance will hold lead and angle variables to within satisfactory limits. Both the variations may produce unacceptable torque and faulty assemblies.

Table 6. Maximum Allowable Variations in Lead and Maximum Equivalent Change in Functional Diameter ANSI/ASME B1.12-1987 (R2003)

Nominal Size	External and Internal Threads	
	Allowable Variation in Axial Lead (Plus or Minus)	Max Equivalent Change in Functional Diam. (Plus for Ext, Minus for Int)
0.2500–20	0.0008	0.0013
0.3125–18	0.0009	0.0015
0.3750–16	0.0009	0.0016
0.4375–14	0.0010	0.0018
0.5000–13	0.0011	0.0018
0.5625–12	0.0012	0.0020
0.6250–11	0.0012	0.0021
0.7500–10	0.0013	0.0022
0.8750– 9	0.0014	0.0024
1.0000– 8	0.0016	0.0027
1.1250– 7	0.0017	0.0030
1.2500– 7	0.0017	0.0030
1.3750– 6	0.0020	0.0036
1.5000– 6	0.0020	0.0036

All dimensions are in inches.

Note: The equivalent change in functional diameter applies to total effect of form errors.

Maximum allowable variation in lead is permitted only when all other form variations are zero.

For sizes not tabulated, maximum allowable variation in lead is equal to 0.57735 times one-half the pitch diameter tolerance.

Table 7. Maximum Allowable Variation in 30° Basic Half-Angle of External and Internal Screw Threads ANSI/ASME B1.12-1987 (R2003)

TPI	Allowable Variation in Half-Angle of Thread (Plus or Minus)	TPI	Allowable Variation in Half-Angle of Thread (Plus or Minus)	TPI	Allowable Variation in Half-Angle of Thread (Plus or Minus)
32	1° 30'	14	0° 55'	8	0° 45'
28	1° 20'	13	0° 55'	7	0° 45'
27	1° 20'	12	0° 50'	6	0° 40'
24	1° 15'	11½	0° 50'	5	0° 40'
20	1° 10'	11	0° 50'	4½	0° 40'
18	1° 05'	10	0° 50'	4	0° 40'
16	1° 00'	9	0° 50'

Spark Plug Threads

British Standard for Spark Plugs BS 45:1972 (withdrawn).—This revised British Standard refers solely to spark plugs used in automobiles and industrial spark ignition internal combustion engines. The basic thread form is that of the ISO metric (see page 1817). In assigning tolerances to the threads of the spark plug and the tapped holes, full consideration has been given to the desirability of achieving the closest possible measure of interchangeability between British spark plugs and engines, and those made to the standards of other ISO Member Bodies.

Basic Thread Dimensions for Spark Plug and Tapped Hole in Cylinder Head

Nom. Size	Pitch	Thread	Major Dia.		Pitch Dia.		Minor Dia.	
			Max.	Min.	Max.	Min.	Max.	Min.
14	1.25	Plug	13.937 ^a	13.725	13.125	12.993	12.402	12.181
14	1.25	Hole		14.00	13.368	13.188	12.912	12.647
18	1.5	Plug	17.933 ^a	17.697	16.959	16.819	16.092	15.845
18	1.5	Hole		18.00	17.216	17.026	16.676	16.376

^aNot specified

All dimensions are given in millimeters.

The tolerance grades for finished spark plugs and corresponding tapped holes in the cylinder head are: for 14 mm size, 6e for spark plugs and 6H for tapped holes which gives a minimum clearance of 0.063 mm; and for 18 mm size, 6e for spark plugs and 6H for tapped holes which gives a minimum clearance of 0.067 mm.

These minimum clearances are intended to prevent the possibility of seizure, as a result of combustion deposits on the bare threads, when removing the spark plugs and applies to both ferrous and non-ferrous materials. These clearances are also intended to enable spark plugs with threads in accordance with this standard to be fitted into existing holes.

SAE Spark-Plug Screw Threads.—The SAE Standard includes the following sizes: $\frac{7}{8}$ -inch nominal diameter with 18 threads per inch; 18-millimeter nominal diameter with a 18-millimeter nominal diameter with 1.5-millimeter pitch; 14-millimeter nominal diameter with a 1.25-millimeter pitch; 10-millimeter nominal diameter with a 1.0 millimeter pitch; $\frac{3}{8}$ -inch nominal diameter with 24 threads per inch; and $\frac{1}{4}$ -inch nominal diameter with 32 threads per inch. During manufacture, in order to keep the wear on the threading tools within permissible limits, the threads in the spark plug GO (ring) gage should be truncated to the maximum minor diameter of the spark plug; and in the tapped hole GO (plug) gage to the minimum major diameter of the tapped hole.

SAE Standard Threads for Spark Plugs

Size ^a Nom. × Pitch	Major Diameter		Pitch Diameter		Minor Diameter	
	Max.	Min.	Max.	Min.	Max.	Min.
Spark Plug Threads, mm (inches)						
M18 × 1.5	17.933 (0.07060)	17.803 (0.7009)	16.959 (0.6677)	16.853 (0.6635)	16.053 (0.6320)	...
M14 × 1.25	13.868 (0.5460)	13.741 (0.5410)	13.104 (0.5159)	12.997 (0.5117)	12.339 (0.4858)	...
M12 × 1.25	11.862 (0.4670)	11.735 (0.4620)	11.100 (0.4370)	10.998 (0.4330)	10.211 (0.4020)	...
M10 × 1.0	9.974 (0.3927)	9.794 (0.3856)	9.324 (0.3671)	9.212 (0.3627)	8.747 (0.3444)	...

SAE Standard Threads for Spark Plugs (Continued)

Size ^a Nom. × Pitch	Major Diameter		Pitch Diameter		Minor Diameter	
	Max.	Min.	Max.	Min.	Max.	Min.
Tapped Hole Threads, mm (inches)						
M18 × 1.5	...	18.039 (0.7102)	17.153 (0.6753)	17.026 (0.6703)	16.426 (0.6467)	16.266 (0.6404)
M14 × 1.25	...	14.034 (0.5525)	13.297 (0.5235)	13.188 (0.5192)	12.692 (0.4997)	12.499 (0.4921)
M12 × 1.25	...	12.000 (0.4724)	11.242 (0.4426)	11.188 (0.4405)	10.559 (0.4157)	10.366 (0.4081)
M10 × 1.0	...	10.000 (0.3937)	9.500 (0.3740)	9.350 (0.3681)	9.153 (0.3604)	8.917 (0.3511)

^aM14 and M18 are preferred for new applications.

In order to keep the wear on the threading tools within permissible limits, the threads in the spark plug GO (ring) gage shall be truncated to the maximum minor diameter of the spark plug, and in the tapped hole GO (plug) gage to the minimum major diameter of the tapped hole. The plain plug gage for checking the minor diameter of the tapped hole shall be the minimum specified. The thread form is that of the ISO metric (see page 1817).

Reprinted with permission © 1990 Society of Automotive Engineers, Inc.

Lamp Base and Electrical Fixture Threads

Lamp Base and Socket Shell Threads.—The “American Standard” threads for lamp base and socket shells are sponsored by the American Society of Mechanical Engineers, the National Electrical Manufacturers’ Association and by most of the large manufacturers of products requiring rolled threads on sheet metal shells or parts, such as lamp bases, fuse plugs, attachment plugs, etc. There are five sizes, designated as the “miniature size,” the “candelabra size,” the “intermediate size,” the “medium size” and the “mogul size.”

Rolled Threads for Screw Shells of Electric Sockets and Lamp Bases— American Standard

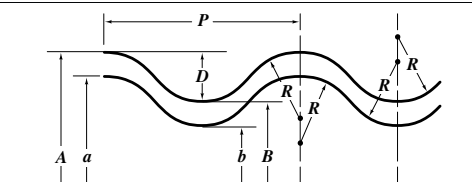

Male or Base Screw Shells Before Assembly								
Size	Threads per Inch	Pitch <i>P</i>	Depth of Thread <i>D</i>	Radius Crest Root <i>R</i>	Major Dia.		Minor Diam.	
					Max. <i>A</i>	Min. <i>a</i>	Max. <i>B</i>	Min. <i>b</i>
Miniature	14	0.07143	0.020	0.0210	0.375	0.370	0.335	0.330
Candelabra	10	0.10000	0.025	0.0312	0.465	0.460	0.415	0.410
Intermediate	9	0.11111	0.027	0.0353	0.651	0.645	0.597	0.591
Medium	7	0.14286	0.033	0.0470	1.037	1.031	0.971	0.965
Mogul	4	0.25000	0.050	0.0906	1.555	1.545	1.455	1.445
Socket Screw Shells Before Assembly								
Miniature	14	0.07143	0.020	0.0210	0.3835	0.3775	0.3435	0.3375
Candelabra	10	0.10000	0.025	0.0312	0.476	0.470	0.426	0.420
Intermediate	9	0.11111	0.027	0.0353	0.664	0.657	0.610	0.603
Medium	7	0.14286	0.033	0.0470	1.053	1.045	0.987	0.979
Mogul	4	0.25000	0.050	0.0906	1.577	1.565	1.477	1.465

All dimensions are in inches.

Base Screw Shell Gage Tolerances: Threaded ring gages—"Go," Max. thread size to minus 0.0003 inch; "Not Go," Min. thread size to plus 0.0003 inch. Plain ring gages—"Go," Max. thread O.D. to minus 0.0002 inch; "Not Go," Min. thread O.D. to plus 0.0002 inch.

Socket Screw Shell Gages: Threaded plug gages—"Go," Min. thread size to plus 0.0003 inch; "Not Go," Max. thread size to minus 0.0003 inch. Plain plug gages—"Go," Min. minor dia. to plus 0.0002 inch; "Not Go," Max. minor dia. to minus 0.0002 inch.

Check Gages for Base Screw Shell Gages: Threaded plugs for checking threaded ring gages—"Go," Max. thread size to minus 0.0003 inch; "Not Go," Min. thread size to plus 0.0003 inch.

Electric Fixture Thread.—The special straight electric fixture thread consists of a straight thread of the same pitches as the American standard pipe thread, and having the regular American or U. S. standard form; it is used for caps, etc. The male thread is smaller, and the female thread larger than those of the special straight-fixture pipe threads. The male thread assembles with a standard taper female thread, while the female thread assembles with a standard taper male thread. This thread is used when it is desired to have the joint "make up" on a shoulder. The gages used are straight-threaded limit gages.

Instrument and Microscope Threads

British Association Standard Thread (BA).—This form of thread is similar to the Whitworth thread in that the root and crest are rounded (see illustration). The angle, however, is only 47 degrees 30 minutes and the radius of the root and crest are proportionately larger. This thread is used in Great Britain and, to some extent, in other European countries for very small screws. Its use in the United States is practically confined to the manufacture of tools for export. This thread system was originated in Switzerland as a standard for watch and clock screws, and it is sometimes referred to as the "Swiss small screw thread standard." See also *Swiss Screw Thread*.

This screw thread system is recommended by the British Standards Institution for use in preference to the BSW and BSF systems for all screws smaller than $\frac{1}{4}$ inch except that the use of the "0" BA thread be discontinued in favor of the $\frac{1}{4}$ -in. BSF. It is further recommended that in the selection of sizes, preference be given to even numbered BA sizes. The thread form is shown by the diagram.

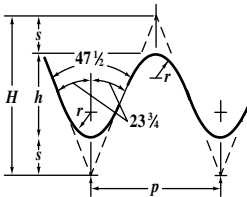

British Association Thread

$$H = 1.13634 \times p$$

$$h = 0.60000 \times p$$

$$r = 0.18083 \times p$$

$$s = 0.26817 \times p$$

It is a symmetrical V-thread, of $47\frac{1}{2}$ degree included angle, having its crests and roots rounded with equal radii, such that the basic depth of the thread is 0.6000 of the pitch. Where p = pitch of thread, H = depth of V-thread, h = depth of BA thread, r = radius at root and crest of thread, and s = root and crest truncation.

British Association (BA) Standard Thread, Basic Dimensions
BS 93:1951 (obsolescent)

Designation Number	Pitch, mm	Depth of Thread, mm	Bolt and Nut			Radius, mm	Threads per Inch (approx.)
			Major Diameter, mm	Effective Diameter, mm	Minor Diameter, mm		
0	1.0000	0.600	6.00	5.400	4.80	0.1808	25.4
1	0.9000	0.540	5.30	4.760	4.22	0.1627	28.2
2	0.8100	0.485	4.70	4.215	3.73	0.1465	31.4
3	0.7300	0.440	4.10	3.660	3.22	0.1320	34.8
4	0.6600	0.395	3.60	3.205	2.81	0.1193	38.5
5	0.5900	0.355	3.20	2.845	2.49	0.1067	43.0
6	0.5300	0.320	2.80	2.480	2.16	0.0958	47.9
7	0.4800	0.290	2.50	2.210	1.92	0.0868	52.9
8	0.4300	0.260	2.20	1.940	1.68	0.0778	59.1
9	0.3900	0.235	1.90	1.665	1.43	0.0705	65.1
10	0.3500	0.210	1.70	1.490	1.28	0.0633	72.6
11	0.3100	0.185	1.50	1.315	1.13	0.0561	82.0
12	0.2800	0.170	1.30	1.130	0.96	0.0506	90.7
13	0.2500	0.150	1.20	1.050	0.90	0.0452	102
14	0.2300	0.140	1.00	0.860	0.72	0.0416	110
15	0.2100	0.125	0.90	0.775	0.65	0.0380	121
16	0.1900	0.115	0.79	0.675	0.56	0.0344	134

Tolerances and Allowances: Two classes of bolts and one for nuts are provided: *Close Class bolts* are intended for precision parts subject to stress, no allowance being provided between maximum bolt and minimum nut sizes. *Normal Class bolts* are intended for general commercial production and general engineering use; for sizes 0 to 10 BA, an allowance of 0.025 mm is provided.

Tolerance Formulas for British Association (BA) Screw Threads

	Class or Fit	Tolerance (+ for nuts, - for bolts)		
		Major Dia.	Effective Dia.	Minor Dia.
Bolts	Close Class 0 to 10 BA incl.	0.15 <i>p</i> mm	0.08 <i>p</i> + 0.02 mm	0.16 <i>p</i> + 0.04 mm
	Normal Class 0 to 10 BA incl.	0.20 <i>p</i> mm	0.10 <i>p</i> + 0.025 mm	0.20 <i>p</i> + 0.05 mm
	Normal Class 11 to 16 BA incl.	0.25 <i>p</i> mm	0.10 <i>p</i> + 0.025 mm	0.20 <i>p</i> + 0.05 mm
Nuts	All Classes		0.12 <i>p</i> + 0.03 mm	0.375 <i>p</i> mm

In these formulas, *p* = pitch in millimeters.

Instrument Makers' Screw Thread System.—The standard screw system of the Royal Microscopical Society of London, also known as the "Society Thread," is employed for microscope objectives and the nose pieces of the microscope into which these objectives screw. The form of the thread is the standard Whitworth form. The number of threads per inch is 36. There is one size only. The maximum pitch diameter of the objective is 0.7804 inch and the minimum pitch diameter of the nose-piece is 0.7822 inch. The dimensions are as follows:

Male thread	outside dia.	max., 0.7982 inch	min., 0.7952 inch
	root dia.	max., 0.7626 inch	min., 0.7596 inch
Female thread	root of thread	max., 0.7674 inch	min., 0.7644 inch
	top of thread	max., 0.8030 inch	min., 0.8000 inch

The Royal Photographic Society Standard Screw Thread ranges from 1-inch diameter upward. For screws less than 1 inch, the Microscopical Society Standard is used. The British Association thread is another thread system employed on instruments abroad.

American Microscope Objective Thread (AMO).—The standard, ANSI B1.11-1958 (R2006), describes the American microscope objective thread, AMO, the screw thread form used for mounting a microscope objective assembly to the body or lens turret of a microscope. This screw thread is also recommended for other microscope optical assem-

bles as well as related applications such as photomicrographic equipment. It is based on, and intended to be interchangeable with, the screw thread produced and adopted many years ago by the Royal Microscopical Society of Great Britain, generally known as the RMS thread. While the standard is almost universally accepted as the basic standard for microscope objective mountings, formal recognition has been extremely limited.

The basic thread possesses the overall British Standard Whitworth form. (See *Whitworth Standard Thread Form* starting on page 1858). However, the actual design thread form implementation is based on the WWII era ASA B1.6-1944 "Truncated Whitworth Form" in which the rounded crests and roots are removed. ASA B1.6-1944 was withdrawn in 1951, however, ANSI B1.11-1958 (R2006) is still active for new design.

Design Requirements of Microscope Objective Threads: Due to the inherent longevity of optical equipment and the repeated use to which the objective threads are subjected, the following factors should be considered when designing microscope objective threads:

Adequate clearance to afford protection against binding due to the presence of foreign particles or minor crest damage.

Sufficient depth of thread engagement to assure security in the short lengths of engagement commonly encountered.

Allowances for limited eccentricities so that centralization and squareness of the objective are not influenced by such errors in manufacture.

Deviation from the Truncated Whitworth Thread Form: Although ANSI B1.11-1958 (R2006) is based on the withdrawn ASA B1.6-1944 truncated Whitworth standard, the previously described design requirements necessitate a deviation from the truncated Whitworth thread form. Some of the more significant modifications are:

A larger allowance on the pitch diameter of the external thread.

Smaller tolerances on the major diameter of the external thread and minor diameter of the internal thread.

The provision of allowances on the major and minor diameters of the external thread.

Thread Overview: The thread is a single start type. There is only one class of thread based on a basic major diameter of 0.800 in. and a pitch, p , of 0.027778 inch (36 threads per inch). The AMO thread shall be designated on drawings, tools and gages as "0.800-36 AMO." Thread nomenclature, definitions and terminology are based on ANSI B1.7-1965 (R1972), "Nomenclature, Threads, and Letter Symbols for Screw Threads."

It should also be noted that ISO 8038-1:1997 "Screw threads for objectives and related nosepieces" is also based on the 0.800 inch, 36 tpi RMS thread form.

Tolerances and Allowances: Tolerances are given in **Table 2**. A positive allowance (minimum clearance) of 0.0018 in. is provided for the pitch diameter E , major diameter D , and minor diameter, K

If interchangeability with full-form Whitworth threads is not required, the allowances for the major and minor diameters are not necessary, because the forms at the root and crest are truncated. In these cases, either both limits or only the maximum limit of the major and minor diameters may be increased by the amount of the allowance, 0.0018 inch.

Lengths of Engagement: The tolerances specified in **Table 2** are applicable to lengths of engagement ranging from $\frac{1}{8}$ in. to $\frac{3}{8}$ inch, approximately 15% to 50% of the basic diameter. Microscope objective assemblies generally have a length of engagement of $\frac{1}{8}$ inch. Lengths exceeding these limits are seldom employed and not covered in this standard.

Gage testing: Recommended ring and plug testing gage dimensions for the 0.800-36 AMO thread size can be found in ANSI B1.11-1958 (R2006), Appendix.

Dimensional Terminology: Because the active standard ANSI B1.11-1958 (R2006) is based on the withdrawn ASA Truncated Whitworth standard, dimensional nomenclature is described below.

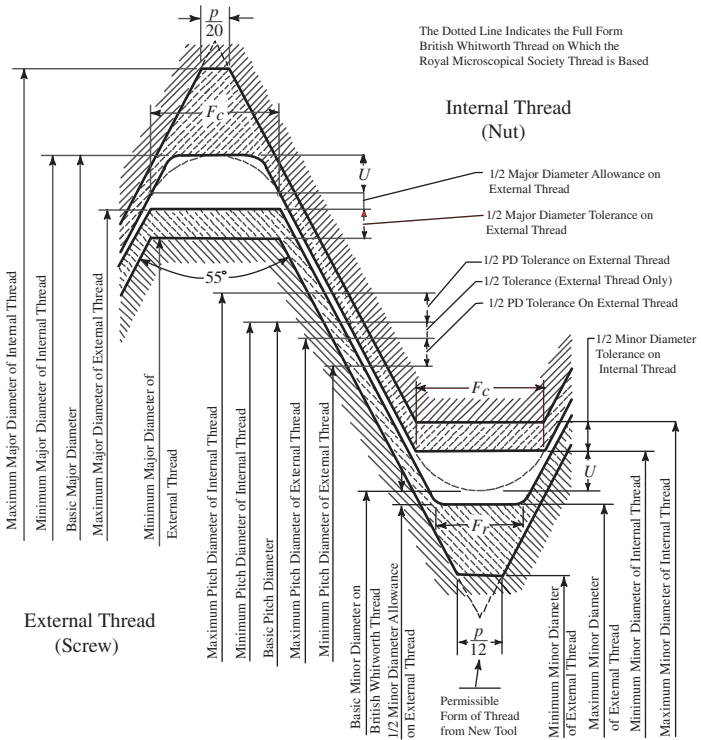

Tolerances, Allowances and Crest Clearances for Microscope Objective Thread (AMO)
 ANSI B1.11-1958 (R2006)

Table 1. Definitions, Formulas, Basic and Design Dimensions
 ANSI B1.11-1958 (R2006)

Symbol	Property	Formula	Dimension
Basic Thread Form			
α	Half angle of thread	...	27°30'
2α	Included angle of thread	...	55°00'
n	Number of threads per inch	...	36
p	Pitch	$1/n$	0.027778
H	Height of fundamental triangle	$0.960491p$	0.026680
h_b	Height of basic thread	$0.640327p$	0.0178
r	Radius at crest and root of British Standard Whitworth basic thread (not used)	$0.137329p$	0.0038

**Table 1. (Continued) Definitions, Formulas, Basic and Design Dimensions
ANSI B1.11-1958 (R2006)**

Symbol	Property	Formula	Dimension
Design Thread Form			
k	Height of truncated Whitworth thread	$h_b - U = 0.566410p$	0.0157
F_c	Width of flat at crest	$0.243624p$	0.0068
F_r	Width of flat at root	$0.166667p$	0.0046
U	Basic truncation of crest from basic Whitworth form	$0.073917p$	0.00205
Basic and Design Sizes			
D	Major diameter, nominal and basic	...	0.800
D_n	Major diameter of internal thread	D	0.800
D_s	Major diameter of external thread ^a	$D - 2U - G$	0.7941
E	Pitch (effective) diameter, basic	$D - h_b$	0.7822
E_n	Pitch (effective) diameter of internal thread	$D - h_b$	0.7822
E_s	Pitch (effective) diameter of external thread ^b	$D - h_b - G$	0.7804
K	Minor diameter, basic	$D - 2h_b$	0.7644
K_n	Minor diameter of internal thread	$D - 2k$	0.7685
K_s	Minor diameter of external thread ^a	$D - 2h_b - G$	0.7626
G	Allowance at pitch (effective) diameter ^{a, b}	...	0.0018

^a An allowance equal to that on the pitch diameter is also provided on the major and minor diameters of the external thread for additional clearance and centralizing.

^b Allowance (minimum clearance) on pitch (effective) diameter is the same as the British RMS thread.

All dimensions are in inches.

**Table 2. Limits of Size and Tolerances — 0.800–36 AMO Thread
ANSI B1.11-1958 (R2006)**

Element	Major Diameter, D			Pitch Diameter, E			Minor Diameter, K		
	Max.	Min.	Tol.	Max.	Min.	Tol.	Max.	Min.	Tol.
External thread	0.7941	0.7911	0.0030	0.7804	0.7774	0.0030	0.7626	0.7552 ^a	...
Internal thread	0.8092 ^b	0.8000	...	0.7852	0.7822	0.0030	0.7715	0.7865	0.0030

^a Extreme minimum minor diameter produced by a new threading tool having a minimum flat of $p/12 = 0.0023$ inch. This minimum diameter is not controlled by gages but by the form of the threading tool.

^b Extreme maximum major diameter produced by a new threading tool having a minimum flat of $p/20 = 0.0014$ inch. This maximum diameter is not controlled by gages but by the form of the threading tool.

Tolerances on the internal thread are applied in a plus direction from the basic and design size and tolerances on the external thread are applied in a minus direction from its design (maximum material) size.

All dimensions are in inches.

Swiss Screw Thread.—This is a thread system originated in Switzerland as a standard for screws used in watch and clock making. The angle between the two sides of the thread is 47 degrees 30 minutes, and the top and bottom of the thread are rounded. This system has been adopted by the British Association as a standard for small screws, and is known as the British Association thread. See *British Association Standard Thread (BA)* on page 1886.

Historical and Miscellaneous Threads

Aero-Thread.—The name “Aero-thread” has been applied to a patented screw thread system that is specially applicable in cases where the nut or internally threaded part is made from a soft material, such as aluminum or magnesium alloy, for the sake of obtaining lightness, as in aircraft construction, and where the screw is made from a high-strength steel to provide strength and good wearing qualities. The nut or part containing the internal thread has a 60-degree truncated form of thread. See Fig. 1. The screw, or stud, is provided with a semi-circular thread form, as shown. Between the screw and the nut there is an intermediary part known as a thread lining or insert, which is made in the form of a helical spring, so that it can be screwed into the nut. The stud, in turn, is then screwed into the thread formed by the semicircular part of the thread insert. When the screw is provided with a V-form of thread, like the American Standard, frequent loosening and tightening of the screw would cause rapid wear of the softer metal from which the nut is made; furthermore, all the threads might not have an even bearing on the mating threads. By using a thread insert which is screwed into the nut permanently, and which is made from a reasonably hard material like phosphor bronze, good wearing qualities are obtained. Also, the bearing or load is evenly distributed over all the threads of the nut since the insert, being in the form of a spring, can adjust itself to bear on all of the thread surfaces.

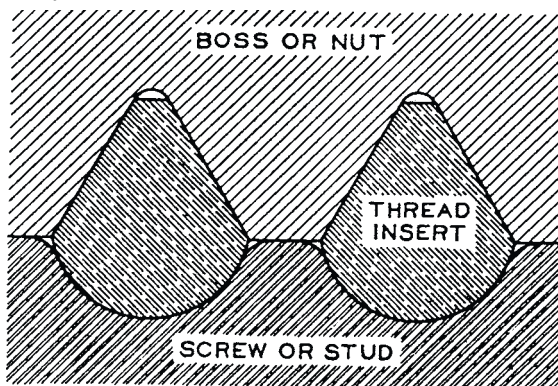

Fig. 1. The Basic Thread Form Used in the Aero-Thread System

Briggs Pipe Thread.—The Briggs pipe thread (now known as the American Standard) is used for threaded pipe joints and is the standard for this purpose in the United States. It derives its name from Robert Briggs.

Casing Thread.—The standard casing thread of the American Petroleum Institute has an included angle of 60 degrees and a taper of $\frac{3}{4}$ inch per foot.

The fourteen casing sizes listed in the 1942 revision have outside diameters ranging from $4\frac{1}{2}$ to 20 inches. All sizes have 8 threads per inch.

Rounded Thread Form: Threads for casing sizes up to $13\frac{3}{8}$ inches, inclusive, have rounded crests and roots, and the depth, measured perpendicular to the axis of the pipe, equals $0.626 \times \text{pitch} - 0.007 = 0.07125$ inch.

Truncated Form: Threads for the 16- and 20-inch casing sizes have flat crests and roots. The depth equals $0.760 \times \text{pitch} = 0.0950$ inch. This truncated form is designated in the A.P.I. Standard as a “sharp thread.”

Cordeaux Thread.—The Cordeaux screw thread derives its name from John Henry Cordeaux, an English telegraph inspector who obtained a patent for this thread in 1877. This thread is used for connecting porcelain insulators with their stalks by means of a screw thread on the stalk and a corresponding thread in the insulator. The thread is approximately a Whitworth thread, 6 threads per inch, the diameters most commonly used being $\frac{5}{8}$ or $\frac{3}{4}$ inch outside diameter of thread; $\frac{5}{8}$ inch is almost universally used for telegraph purposes, while a limited number of $\frac{3}{4}$ -inch sizes are used for large insulators.

Dardelet Thread.—The Dardelet patented self-locking thread is designed to resist vibrations and remain tight without auxiliary locking devices. The locking surfaces are the tapered root of the bolt thread and the tapered crest of the nut thread. The nut is free to turn until seated tightly against a resisting surface, thus causing it to shift from the free position (indicated by dotted lines) to the locking position. The locking is due to a wedging action between the tapered crest of the nut thread and the tapered root or binding surface of the bolt thread. This self-locking thread is also applied to set-screws and cap-screws. The holes must, of course, be threaded with Dardelet taps. The abutment sides of the Dardelet thread carry the major part of the tensile load. The nut is unlocked simply by turning it backward with a wrench. The Dardelet thread can either be cut or rolled, using standard equipment provided with tools, taps, dies, or rolls made to suit the Dardelet thread profile. The included thread angle is 29 degrees; depth $E = 0.3P$; maximum axial movement = $0.28P$. The major internal thread diameter (standard series) equals major external thread diameter plus 0.003 inch except for $\frac{1}{4}$ -inch size which is plus 0.002 inch. The width of both external and internal threads at pitch line equals $0.36P$.

“Drunken” Thread.—A “drunken” thread, according to prevalent usage of this expression by machinists, etc., is a thread that does not coincide with a true helix or advance uniformly. This irregularity in a taper thread may be due to the fact that in taper turning with the tailstock set over, the work does not turn with a uniform angular velocity, while the cutting tool is advancing along the work longitudinally with a uniform linear velocity. The change in the pitch and the irregularity of the thread is so small as to be imperceptible to the eye, if the taper is slight, but as the tapers increase to, say, $\frac{3}{4}$ inch per foot or more, the errors become more pronounced. To avoid this defect, a taper attachment should be used for taper thread cutting.

Echols Thread.—Chip room is of great importance in machine taps and taper taps where the cutting speed is high and always in one direction. The tap as well as the nut to be threaded is liable to be injured, if ample space for the chips to pass away from the cutting edges is not provided. A method of decreasing the number of cutting edges, as well as increasing the amount of chip room, is embodied in the “Echols thread,” where every alternate tooth is removed. If a tap has an even number of flutes, the removal of every other tooth in the lands will be equivalent to the removal of the teeth of a continuous thread. It is, therefore, necessary that taps provided with this thread be made with an odd number of lands, so that removing the tooth in alternate lands may result in removing every other tooth in each individual land. Machine taps are often provided with the Echols thread.

French Thread (S.F.).—The French thread has the same form and proportions as the American Standard (formerly U. S. Standard). This French thread is being displaced gradually by the International Metric Thread System.

Harvey Grip Thread.—The characteristic feature of this thread is that one side inclines 44 degrees from a line at right angles to the axis, whereas the other side has an inclination of only 1 degree. This form of thread is sometimes used when there is considerable resistance or pressure in an axial direction and when it is desirable to reduce the radial or bursting pressure on the nut as much as possible. See *BUTTRESS THREADS*.

Lloyd & Lloyd Thread.—The Lloyd & Lloyd screw thread is the same as the regular Whitworth screw thread in which the sides of the thread form an angle of 55 degrees with one another. The top and bottom of the thread are rounded.

Lock-Nut Pipe Thread.—The lock-nut pipe thread is a straight thread of the largest diameter which can be cut on a pipe. Its form is identical with that of the American or Briggs standard taper pipe thread. In general, “Go” gages only are required. These consist of a straight-threaded plug representing the minimum female lock-nut thread, and a straight-threaded ring representing the maximum male lock-nut thread. This thread is used only to hold parts together, or to retain a collar on the pipe. It is never used where a tight threaded joint is required.

Philadelphia Carriage Bolt Thread.—This is a screw thread for carriage bolts which is somewhat similar to a square thread, but having rounded corners at the top and bottom. The sides of the thread are inclined to an inclusive angle of $3\frac{1}{2}$ degrees. The width of the thread at the top is 0.53 times the pitch.

SAE Standard Screw Thread.—The screw thread standard of the Society of Automotive Engineers (SAE) is intended for use in the automotive industries of the United States. The SAE Standard includes a Coarse series, a Fine series, an 8-thread series, a 12-thread series, a 16-thread series, an Extra-fine series, and a Special-pitch series. The Coarse and Fine series, and also the 8-, 12- and 16-thread series, are exactly the same as corresponding series in the American Standard. The Extra-fine and Special-pitch series are SAE Standards only.

The American Standard thread *form* (or the form previously known as the U. S. Standard) is applied to all SAE Standard screw threads. The Extra-fine series has a total of six pitches ranging from 32 down to 16 threads per inch. The 16 threads per inch in the Extra-fine series, applies to all diameters from $1\frac{3}{4}$ up to 6 inches. This Extra-fine series is intended for use on relatively light sections; on parts requiring fine adjustment; where jar and vibration are important factors; when the thickness of a threaded section is relatively small as in tubing, and where assembly is made without the use of wrenches.

The SAE Special pitches include some which are finer than any in the Extra-fine series. The special pitches apply to a range of diameters extending from No. 10 (0.1900 inch) up to 6 inches. Each diameter has a range of pitches varying from five to eight. For example, a $\frac{1}{4}$ -inch diameter has six pitches ranging from 24 to 56 threads per inch, whereas a 6-inch diameter has eight pitches ranging from 4 to 16 threads per inch. These various SAE Standard series are intended to provide adequate screw thread specifications for all uses in the automotive industries.

Sellers Screw Thread.—The Sellers screw thread, later known as the “United States standard thread,” and now as the “American Standard,” is the most commonly used screw thread in the United States. It was originated by William Sellers, of Philadelphia, and first proposed by him in a paper read before the Franklin Institute, in April, 1864. In 1868, it was adopted by the United States Navy and has since become the generally accepted standard screw thread in the United States.

Worm Threads.—The included angle of worm threads range from 29° to 60° ; for single-threaded worms 29° is common; multiple-threaded type must have larger helix and thread angles to avoid excessive under-cutting in hobbing the worm-wheel teeth. AGMA recommends 40° included thread angle for triple- and quadruple-thread worms, but many speed reducers and transmissions have 60° thread angles. The 29° angle is the same as the Acme thread, but worm thread depth is greater and widths of the flats at the top and bottom are less. If lead angle is larger than 20° , an increase in included thread angle is desirable. Worm gearing reaches maximum efficiency when lead angle is 45° , thus explaining the 60° thread angle. Thread parts of a 29° worm thread are: p = pitch; d = depth of thread = $0.6866p$; t = width, top of thread = $0.335p$; b = width, bottom of thread = $0.310p$.

MEASURING SCREW THREADS

Measuring Screw Threads

Pitch and Lead of Screw Threads.—The *pitch* of a screw thread is the distance from the center of one thread to the center of the next thread. This applies no matter whether the screw has a single, double, triple or quadruple thread. The *lead* of a screw thread is the distance the nut will move forward on the screw if it is turned around one full revolution. In a single-threaded screw, the pitch and lead are equal, because the nut would move forward the distance from one thread to the next, if turned around once. In a double-threaded screw, the nut will move forward two threads, or twice the pitch, so that in this case the lead equals twice the pitch. In a triple-threaded screw, the lead equals three times the pitch, and so on.

The word "pitch" is often, although improperly, used to denote the *number of threads per inch*. Screws are spoken of as having a 12-pitch thread, when twelve threads per inch is what is really meant. The number of threads per inch equals 1 divided by the pitch, or expressed as a formula:

$$\text{Number of threads per inch} = \frac{1}{\text{pitch}}$$

The pitch of a screw equals 1 divided by the number of threads per inch, or:

$$\text{Pitch} = \frac{1}{\text{number of threads per inch}}$$

If the number of threads per inch equals 16, the pitch = $\frac{1}{16}$. If the pitch equals 0.05, the number of threads equals $1 \div 0.05 = 20$. If the pitch is $\frac{2}{5}$ inch, the number of threads per inch equals $1 \div \frac{2}{5} = 2 \frac{1}{2}$.

Confusion is often caused by the indefinite designation of multiple-thread screws (double, triple, quadruple, etc.). The expression, "four threads per inch, triple," for example, is not to be recommended. It means that the screw is cut with four triple threads or with twelve threads per inch, if the threads are counted by placing a scale alongside the screw. To cut this screw, the lathe would be geared to cut four threads per inch, but they would be cut only to the depth required for twelve threads per inch. The best expression, when a multiple-thread is to be cut, is to say, in this case, " $\frac{1}{4}$ inch lead, $\frac{1}{12}$ inch pitch, triple thread." For single-threaded screws, only the number of threads per inch and the form of the thread are specified. The word "single" is not required.

Measuring Screw Thread Pitch Diameters by Thread Micrometers.—As the pitch or angle diameter of a tap or screw is the most important dimension, it is necessary that the pitch diameter of screw threads be measured, in addition to the outside diameter.

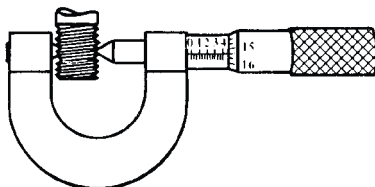

Fig. 1.

One method of measuring in the angle of a thread is by means of a special screw thread micrometer, as shown in the accompanying engraving, Fig. 1. The fixed anvil is W-shaped to engage two thread flanks, and the movable point is cone-shaped so as to enable it to enter the space between two threads, and at the same time be at liberty to revolve. The contact

points are on the sides of the thread, as they necessarily must be in order that the pitch diameter may be determined. The cone-shaped point of the measuring screw is slightly rounded so that it will not bear in the bottom of the thread. There is also sufficient clearance at the bottom of the V-shaped anvil to prevent it from bearing on the top of the thread. The movable point is adapted to measuring all pitches, but the fixed anvil is limited in its capacity. To cover the whole range of pitches, from the finest to the coarsest, a number of fixed anvils are therefore required.

To find the theoretical pitch diameter, which is measured by the micrometer, subtract twice the addendum of the thread from the standard outside diameter. The addendum of the thread for the American and other standard threads is given in the section on screw thread systems.

Ball-point Micrometers.—If standard plug gages are available, it is not necessary to actually measure the pitch diameter, but merely to compare it with the standard gage. In this case, a ball-point micrometer, as shown in Fig. 2, may be employed. Two types of ball-point micrometers are ordinarily used. One is simply a regular plain micrometer with ball points made to slip over both measuring points. (See B, Fig. 2.) This makes a kind of combination plain and ball-point micrometer, the ball points being easily removed. These ball points, however, do not fit solidly on their seats, even if they are split, as shown, and are apt to cause errors in measurements. The best, and, in the long run, the cheapest, method is to use a regular micrometer arranged as shown at A. Drill and ream out both the end of the measuring screw or spindle and the anvil, and fit ball points into them as shown. Care should be taken to have the ball point in the spindle run true. The holes in the micrometer spindle and anvil and the shanks on the points are tapered to insure a good fit. The hole *H* in spindle *G* is provided so that the ball point can be easily driven out when a change for a larger or smaller size of ball point is required.

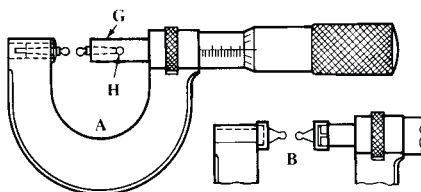

Fig. 2.

A ball-point micrometer may be used for comparing the *angle* of a screw thread, with that of a gage. This can be done by using different sizes of ball points, comparing the size first near the root of the thread, then (using a larger ball point) at about the point of the pitch diameter, and finally near the top of the thread (using in the latter case, of course, a much larger ball point). If the gage and thread measurements are the same at each of the three points referred to, this indicates that the thread angle is correct.

Measuring Screw Threads by Three-wire Method.—The *effective* or *pitch diameter* of a screw thread may be measured very accurately by means of some form of micrometer and three wires of equal diameter. This method is extensively used in checking the accuracy of threaded plug gages and other precision screw threads. Two of the wires are placed in contact with the thread on one side and the third wire in a position diametrically opposite as illustrated by the diagram, (see table "Formulas for Checking Pitch Diameters of Screw Threads") and the dimension over the wires is determined by means of a micrometer. An ordinary micrometer is commonly used but some form of "floating micrometer" is preferable, especially for measuring thread gages and other precision work. The floating micrometer is mounted upon a compound slide so that it can move freely in directions parallel or at right angles to the axis of the screw, which is held in a horizontal position

between adjustable centers. With this arrangement the micrometer is held constantly at right angles to the axis of the screw so that only one wire on each side may be used instead of having two on one side and one on the other, as is necessary when using an ordinary micrometer. The pitch diameter may be determined accurately if the correct micrometer reading for wires of a given size is known.

Classes of Formulas for Three-Wire Measurement.—Various formulas have been established for checking the pitch diameters of screw threads by measurement over wires of known size. These formulas differ with regard to their simplicity or complexity and resulting accuracy. They also differ in that some show what measurement M over the wires should be to obtain a given pitch diameter E , whereas others show the value of the pitch diameter E for a given measurement M .

Formulas for Finding Measurement M : In using a formula for finding the value of measurement M , the required pitch diameter E is inserted in the formula. Then, in cutting or grinding a screw thread, the actual measurement M is made to conform to the calculated value of M . Formulas for finding measurement M may be modified so that the basic major or outside diameter is inserted in the formula instead of the pitch diameter; however, the pitch-diameter type of formula is preferable because the pitch diameter is a more important dimension than the major diameter.

Formulas for Finding Pitch Diameters E : Some formulas are arranged to show the value of the pitch diameter E when measurement M is known. Thus, the value of M is first determined by measurement and then is inserted in the formula for finding the corresponding pitch diameter E . This type of formula is useful for determining the pitch diameter of an existing thread gage or other screw thread in connection with inspection work. The formula for finding measurement M is more convenient to use in the shop or tool room in cutting or grinding new threads, because the pitch diameter is specified on the drawing and the problem is to find the value of measurement M for obtaining that pitch diameter.

General Classes of Screw Thread Profiles.—Thread profiles may be divided into three general classes or types as follows:

Screw Helicoid: Represented by a screw thread having a straight-line profile in the axial plane. Such a screw thread may be cut in a lathe by using a straight-sided single-point tool, provided the top surface lies in the axial plane.

Involute Helicoid: Represented either by a screw thread or a helical gear tooth having an involute profile in a plane perpendicular to the axis. A rolled screw thread, theoretically at least, is an exact involute helicoid.

Intermediate Profiles: An intermediate profile that lies somewhere between the screw helicoid and the involute helicoid will be formed on a screw thread either by milling or grinding with a straight-sided wheel set in alignment with the thread groove. The resulting form will approach closely the involute helicoid form. In milling or grinding a thread, the included cutter or wheel angle may either equal the standard thread angle (which is always measured in the axial plane) or the cutter or wheel angle may be reduced to approximate, at least, the thread angle in the normal plane. In practice, all these variations affect the three-wire measurement.

Accuracy of Formulas for Checking Pitch Diameters by Three-Wire Method.—The exact measurement M for a given pitch diameter depends upon the lead angle, the thread angle, and the profile or cross-sectional shape of the thread. As pointed out in the preceding paragraph, the profile depends upon the method of cutting or forming the thread. In a milled or ground thread, the profile is affected not only by the cutter or wheel angle, but also by the diameter of the cutter or wheel; hence, because of these variations, an absolutely exact and reasonably simple general formula for measurement M cannot be established; however, if the lead angle is low, as with a standard single-thread screw, and especially if the thread angle is high like a 60-degree thread, simple formulas that are not arranged to compensate for the lead angle are used ordinarily and meet most practical

requirements, particularly in measuring 60-degree threads. If lead angles are large enough to greatly affect the result, as with most multiple threads (especially Acme or 29-degree worm threads), a formula should be used that compensates for the lead angle sufficiently to obtain the necessary accuracy.

The formulas that follow include 1) a very simple type in which the effect of the lead angle on measurement M is entirely ignored. This simple formula usually is applicable to the measurement of 60-degree single-thread screws, except possibly when gage-making accuracy is required; 2) formulas that do include the effect of the lead angle but, nevertheless, are approximations and not always suitable for the higher lead angles when extreme accuracy is required; and 3) formulas for the higher lead angles and the most precise classes of work.

Where approximate formulas are applied consistently in the measurement of both thread plug gages and the thread "setting plugs" for ring gages, interchangeability might be secured, assuming that such approximate formulas were universally employed.

Wire Sizes for Checking Pitch Diameters of Screw Threads.—In checking screw threads by the 3-wire method, the general practice is to use measuring wires of the so-called "best size." The "best-size" wire is one that contacts at the pitch line or midslope of the thread because then the measurement of the pitch diameter is least affected by an error in the thread angle. In the following formula for determining approximately the "best-size" wire or the diameter for pitch-line contact, A = one-half included angle of thread in the axial plane.

$$\text{Best-size wire} = \frac{0.5 \times \text{pitch}}{\cos A} = 0.5 \text{ pitch} \times \sec A$$

For 60-degree threads, this formula reduces to

$$\text{Best-size wire} = 0.57735 \times \text{pitch}$$

Diameters of Wires for Measuring American Standard and British Standard Whitworth Screw Threads

Threads per Inch	Pitch, Inch	Wire Diameters for American Standard Threads			Wire Diameters for Whitworth Standard Threads		
		Max.	Min.	Pitch-Line Contact	Max.	Min.	Pitch-Line Contact
4	0.2500	0.2250	0.1400	0.1443	0.1900	0.1350	0.1409
4½	0.2222	0.2000	0.1244	0.1283	0.1689	0.1200	0.1253
5	0.2000	0.1800	0.1120	0.1155	0.1520	0.1080	0.1127
5½	0.1818	0.1636	0.1018	0.1050	0.1382	0.0982	0.1025
6	0.1667	0.1500	0.0933	0.0962	0.1267	0.0900	0.0939
7	0.1428	0.1283	0.0800	0.0825	0.1086	0.0771	0.0805
8	0.1250	0.1125	0.0700	0.0722	0.0950	0.0675	0.0705
9	0.1111	0.1000	0.0622	0.0641	0.0844	0.0600	0.0626
10	0.1000	0.0900	0.0560	0.0577	0.0760	0.0540	0.0564
11	0.0909	0.0818	0.0509	0.0525	0.0691	0.0491	0.0512
12	0.0833	0.0750	0.0467	0.0481	0.0633	0.0450	0.0470
13	0.0769	0.0692	0.0431	0.0444	0.0585	0.0415	0.0434
14	0.0714	0.0643	0.0400	0.0412	0.0543	0.0386	0.0403
16	0.0625	0.0562	0.0350	0.0361	0.0475	0.0337	0.0352
18	0.0555	0.0500	0.0311	0.0321	0.0422	0.0300	0.0313
20	0.0500	0.0450	0.0280	0.0289	0.0380	0.0270	0.0282
22	0.0454	0.0409	0.0254	0.0262	0.0345	0.0245	0.0256
24	0.0417	0.0375	0.0233	0.0240	0.0317	0.0225	0.0235
28	0.0357	0.0321	0.0200	0.0206	0.0271	0.0193	0.0201
32	0.0312	0.0281	0.0175	0.0180	0.0237	0.0169	0.0176
36	0.0278	0.0250	0.0156	0.0160	0.0211	0.0150	0.0156
40	0.0250	0.0225	0.0140	0.0144	0.0190	0.0135	0.0141

These formulas are based upon a thread groove of zero lead angle because ordinary variations in the lead angle have little effect on the wire diameter and it is desirable to use one wire size for a given pitch regardless of the lead angle. A theoretically correct solution for finding the *exact* size for pitch-line contact involves the use of cumbersome indeterminate equations with solution by successive trials. The accompanying table gives the wire sizes for both American Standard (formerly, U.S. Standard) and the Whitworth Standard Threads. The following formulas for determining wire diameters do not give the extreme theoretical limits, but the smallest and largest practicable sizes. The diameters in the table are based upon these approximate formulas.

American Standard	Smallest wire diameter = $0.56 \times \text{pitch}$
	Largest wire diameter = $0.90 \times \text{pitch}$
	Diameter for pitch-line contact = $0.57735 \times \text{pitch}$
Whitworth	Smallest wire diameter = $0.54 \times \text{pitch}$
	Largest wire diameter = $0.76 \times \text{pitch}$
	Diameter for pitch-line contact = $0.56369 \times \text{pitch}$

Measuring Wire Accuracy.—A set of three measuring wires should have the same diameter within 0.0002 inch. To measure the pitch diameter of a screw-thread gage to an accuracy of 0.0001 inch by means of wires, it is necessary to know the wire diameters to 0.00002 inch. If the diameters of the wires are known only to an accuracy of 0.0001 inch, an accuracy better than 0.0003 inch in the measurement of pitch diameter cannot be expected. The wires should be accurately finished hardened steel cylinders of the maximum possible hardness without being brittle. The hardness should not be less than that corresponding to a Knoop indentation number of 630. A wire of this hardness can be cut with a file only with difficulty. The surface should not be rougher than the equivalent of a deviation of 3 microinches from a true cylindrical surface.

Measuring or Contact Pressure.—In measuring screw threads or screw-thread gages by the 3-wire method, variations in contact pressure will result in different readings. The effect of a variation in contact pressure in measuring threads of fine pitches is indicated by the difference in readings obtained with pressures of 2 and 5 pounds in checking a thread plug gage having 24 threads per inch. The reading over the wires with 5 pounds pressure was 0.00013 inch less than with 2 pounds pressure. For pitches finer than 20 threads per inch, a pressure of 16 ounces is recommended by the National Bureau of Standards, now National Institute of Standards and Technology (NIST). For pitches of 20 threads per inch and coarser, a pressure of $2 \frac{1}{2}$ pounds is recommended.

For Acme threads, the wire presses against the sides of the thread with a pressure of approximately twice that of the measuring instrument. To limit the tendency of the wires to wedge in between the sides of an Acme thread, it is recommended that pitch-diameter measurements be made at 1 pound on 8 threads per inch and finer, and at $2 \frac{1}{2}$ pounds for pitches coarser than 8 threads per inch.

Approximate Three-Wire Formulas That Do Not Compensate for Lead Angle.—A general formula in which the effect of lead angle is ignored is as follows (see accompanying notation used in formulas):

$$M = E - T \cot A + W(1 + \csc A) \quad (1)$$

This formula can be simplified for any given thread angle and pitch. To illustrate, because $T = 0.5P$, $M = E - 0.5P \cot 30^\circ + W(1 + 2)$, for a 60-degree thread, such as the American Standard,

$$M = E - 0.866025P + 3W$$

The accompanying table contains these simplified formulas for different standard threads. Two formulas are given for each. The upper one is used when the measurement over wires, M , is known and the corresponding pitch diameter, E , is required; the lower formula gives the measurement M for a specified value of pitch diameter. These formulas are sufficiently accurate for checking practically all standard 60-degree single-thread screws because of the low lead angles, which vary from $1^\circ 11'$ to $4^\circ 31'$ in the American Standard Coarse-Thread Series.

Bureau of Standards (now NIST) General Formula.—**Formula (2)**, which follows, compensates quite largely for the effect of the lead angle. It is from the National Bureau of Standards Handbook H 28 (1944), now FED-STD-H28. The formula, however, as here given has been arranged for finding the value of M (instead of E).

$$M = E - T \cot A + W(1 + \csc A + 0.5 \tan^2 B \cos A \cot A) \quad (2)$$

This expression is also found in ANSI/ASME B1.2-1983 (R2007). The Bureau of Standards uses **Formula (2)** in preference to **Formula (1)** when the value of $0.5W \tan^2 B \cos A \cot A$ exceeds 0.00015, with the larger lead angles. If this test is applied to American Standard 60-degree threads, it will show that **Formula (1)** is generally applicable; but for 29-degree Acme or worm threads, **Formula (2)** (or some other that includes the effect of lead angle) should be employed.

Notation Used in Formulas for Checking Pitch Diameters by Three-Wire Method

- A = one-half included thread angle in the axial plane
- A_n = one-half included thread angle in the normal plane or in plane perpendicular to sides of thread = one-half included angle of cutter when thread is milled ($\tan A_n = \tan A \times \cos B$). (Note: Included angle of milling cutter or grinding wheel may equal the nominal included angle of thread, or may be reduced to whatever normal angle is required to make the thread angle standard in the axial plane. In either case, A_n = one-half cutter angle.)
- B = lead angle at pitch diameter = helix angle of thread as measured from a plane perpendicular to the axis, $\tan B = L \div 3.1416E$
- D = basic major or outside diameter
- E = pitch diameter (basic, maximum, or minimum) for which M is required, or pitch diameter corresponding to measurement M
- F = angle required in **Formulas (4b)**, **(4d)**, and **(4e)**
- G = angle required in **Formula (4)**
- H = helix angle at pitch diameter and measured from axis = $90^\circ - B$ or $\tan H = \cot B$
- H_b = helix angle at R_b measured from axis
- L = lead of thread = pitch $P \times$ number of threads S
- M = dimension over wires
- P = pitch = $1 \div$ number of threads per inch
- R_b = radius required in **Formulas (4)** and **(4e)**
- S = number of "starts" or threads on a multiple-threaded worm or screw
- $T = 0.5 P$ = width of thread in axial plane at diameter E
- T_a = arc thickness on pitch cylinder in plane perpendicular to axis
- W = wire or pin diameter

Formulas for Checking Pitch Diameters of Screw Threads

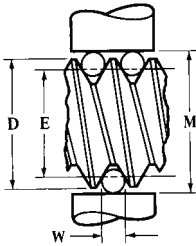

The formulas below do not compensate for the effect of the lead angle upon measurement M , but they are sufficiently accurate for checking standard single-thread screws unless exceptional accuracy is required. See accompanying information on effect of lead angle; also matter relating to measuring wire sizes, accuracy required for such wires, and contact or measuring pressure.

The approximate best wire size for pitch-line contact may be obtained by the formula

$$W = 0.5 \times \text{pitch} \times \sec \frac{1}{2} \text{ included thread angle}$$

For 60-degree threads, $W = 0.57735 \times \text{pitch}$.

Form of Thread	Formulas for determining measurement M corresponding to correct pitch diameter and the pitch diameter E corresponding to a given measurement over wires. ^a
American National Standard Unified	When measurement M is known, $E = M + 0.86603P - 3W$ When pitch diameter E is used in formula, $M = E - 0.86603P + 3W$ The American Standard formerly was known as U.S. Standard.
British Standard Whitworth	When measurement M is known, $E = M + 0.9605P - 3.1657W$ When pitch diameter E is used in formula, $M = E - 0.9605P + 3.1657W$
British Association Standard	When measurement M is known, $E = M + 1.1363P - 3.4829W$ When pitch diameter E is used in formula, $M = E - 1.1363P + 3.4829W$
Lowenherz Thread	When measurement M is known, $E = M + P - 3.2359W$ When pitch diameter E is used in formula, $M = E - P + 3.2359W$
Sharp V-Thread	When measurement M is known, $E = M + 0.86603P - 3W$ When pitch diameter E is used in formula, $M = E - 0.86603P + 3W$
International Standard	Use the formula above for the American National Standard Unified Thread.
Pipe Thread	See accompanying paragraph on <i>Buckingham Exact Involute Helicoid Formula Applied to Screw Threads</i> .
Acme and Worm Threads	See Buckingham Formulas page 1904; also <i>Three-wire Measurement of Acme and Stub Acme Thread Pitch Diameter</i> .
Buttress Form of Thread	Different forms of buttress threads are used. See paragraph on <i>Three-Wire Method Applied to Buttress Threads</i> .

^aThe wires must be lapped to a uniform diameter and it is very important to insert in the rule or formula the wire diameter as determined by precise means of measurement. Any error will be multiplied. See paragraph on *Wire Sizes for Checking Pitch Diameters of Screw Threads* on page 1897.

Why Small Thread Angle Affects Accuracy of Three-Wire Measurement.—In measuring or checking Acme threads, or any others having a comparatively small thread angle A , it is particularly important to use a formula that compensates largely, if not entirely, for the effect of the lead angle, especially in all gage and precision work. The effect of the lead angle on the position of the wires and upon the resulting measurement M is much greater in a 29-degree thread than in a higher thread angle such, for example, as a 60-degree thread. This effect results from an increase in the cotangent of the thread angle as this angle becomes smaller. The reduction in the width of the thread groove in the normal plane due

to the lead angle causes a wire of given size to rest higher in the groove of a thread having a small thread angle A (like a 29-degree thread) than in the groove of a thread with a larger angle (like a 60-degree American Standard).

Acme Threads: Three-wire measurements of high accuracy require the use of **Formula (4)**. For most measurements, however, **Formula (2)** or **(3)** gives satisfactory results. The table on page 1907 lists suitable wire sizes for use in **Formulas (2)** and **(4)**.

Values of Constants Used in Formulas for Measuring Pitch Diameters of Screws by the Three-wire System

No. of Threads per Inch	American Standard Unified and Sharp V-Thread 0.866025P	Whitworth Thread 0.9605P	No. of Threads per Inch	American Standard Unified and Sharp V-Thread 0.866025P	Whitworth Thread 0.9605P
2¼	0.38490	0.42689	18	0.04811	0.05336
2⅝	0.36464	0.40442	20	0.04330	0.04803
2½	0.34641	0.38420	22	0.03936	0.04366
2⅞	0.32992	0.36590	24	0.03608	0.04002
2¾	0.31492	0.34927	26	0.03331	0.03694
2⅞	0.30123	0.33409	28	0.03093	0.03430
3	0.28868	0.32017	30	0.02887	0.03202
3¼	0.26647	0.29554	32	0.02706	0.03002
3½	0.24744	0.27443	34	0.02547	0.02825
4	0.21651	0.24013	36	0.02406	0.02668
4½	0.19245	0.21344	38	0.02279	0.02528
5	0.17321	0.19210	40	0.02165	0.02401
5½	0.15746	0.17464	42	0.02062	0.02287
6	0.14434	0.16008	44	0.01968	0.02183
7	0.12372	0.13721	46	0.01883	0.02088
8	0.10825	0.12006	48	0.01804	0.02001
9	0.09623	0.10672	50	0.01732	0.01921
10	0.08660	0.09605	52	0.01665	0.01847
11	0.07873	0.08732	56	0.01546	0.01715
12	0.07217	0.08004	60	0.01443	0.01601
13	0.06662	0.07388	64	0.01353	0.01501
14	0.06186	0.06861	68	0.01274	0.01412
15	0.05774	0.06403	72	0.01203	0.01334
16	0.05413	0.06003	80	0.01083	0.01201

Constants Used for Measuring Pitch Diameters of Metric Screws by the Three-wire System

Pitch in mm	0.866025P in Inches	W in Inches	Pitch in mm	0.866025P in Inches	W in Inches	Pitch in mm	0.866025P in Inches	W in Inches
0.2	0.00682	0.00455	0.75	0.02557	0.01705	3.5	0.11933	0.07956
0.25	0.00852	0.00568	0.8	0.02728	0.01818	4	0.13638	0.09092
0.3	0.01023	0.00682	1	0.03410	0.02273	4.5	0.15343	0.10229
0.35	0.01193	0.00796	1.25	0.04262	0.02841	5	0.17048	0.11365
0.4	0.01364	0.00909	1.5	0.05114	0.03410	5.5	0.18753	0.12502
0.45	0.01534	0.01023	1.75	0.05967	0.03978	6	0.20457	0.13638
0.5	0.01705	0.01137	2	0.06819	0.04546	8	0.30686	0.18184
0.6	0.02046	0.01364	2.5	0.08524	0.05683
0.7	0.02387	0.01591	3	0.10229	0.06819

This table may be used for American National Standard Metric Threads. The formulas for American Standard Unified Threads on page 1900 are used. In the table above, the values of 0.866025P and W are in inches so that the values for E and M calculated from the formulas on page 1900 are also in inches.

Dimensions Over Wires of Given Diameter for Checking Screw Threads of American National Form (U.S. Standard) and the V-Form

Dia. of Thread	No. of Threads per Inch	Wire Dia. Used	Dimension over Wires		Dia. of Thread	No. of Threads per Inch	Wire Dia. Used	Dimension over Wires	
			V-Thread	U.S. Thread				V-Thread	U.S. Thread
1/4	18	0.035	0.2588	0.2708	7/8	8	0.090	0.9285	0.9556
1/4	20	0.035	0.2684	0.2792	7/8	9	0.090	0.9525	0.9766
1/4	22	0.035	0.2763	0.2861	7/8	10	0.090	0.9718	0.9935
1/4	24	0.035	0.2828	0.2919	15/16	8	0.090	0.9910	1.0181
5/16	18	0.035	0.3213	0.3333	15/16	9	0.090	1.0150	1.0391
5/16	20	0.035	0.3309	0.3417	1	8	0.090	1.0535	1.0806
5/16	22	0.035	0.3388	0.3486	1	9	0.090	1.0775	1.1016
5/16	24	0.035	0.3453	0.3544	1 1/8	7	0.090	1.1476	1.1785
3/8	16	0.040	0.3867	0.4003	1 1/4	7	0.090	1.2726	1.3035
3/8	18	0.040	0.3988	0.4108	1 3/8	6	0.150	1.5363	1.5724
3/8	20	0.040	0.4084	0.4192	1 1/2	6	0.150	1.6613	1.6974
7/16	14	0.050	0.4638	0.4793	1 5/8	5 1/2	0.150	1.7601	1.7995
7/16	16	0.050	0.4792	0.4928	1 3/4	5	0.150	1.8536	1.8969
1/2	12	0.050	0.5057	0.5237	1 7/8	5	0.150	1.9786	2.0219
1/2	13	0.050	0.5168	0.5334	2	4 1/2	0.150	2.0651	2.1132
1/2	14	0.050	0.5263	0.5418	2 1/4	4 1/2	0.150	2.3151	2.3632
9/16	12	0.050	0.5682	0.5862	2 1/2	4	0.150	2.5170	2.5711
9/16	14	0.050	0.5888	0.6043	2 3/4	4	0.150	2.7670	2.8211
5/8	10	0.070	0.6618	0.6835	3	3 1/2	0.200	3.1051	3.1670
5/8	11	0.070	0.6775	0.6972	3 1/4	3 1/2	0.200	3.3551	3.4170
5/8	12	0.070	0.6907	0.7087	3 1/2	3 1/4	0.250	3.7171	3.7837
1 1/16	10	0.070	0.7243	0.7460	3 3/4	3	0.250	3.9226	3.9948
1 1/16	11	0.070	0.7400	0.7597	4	3	0.250	4.1726	4.2448
3/4	10	0.070	0.7868	0.8085	4 1/4	2 7/8	0.250	4.3975	4.4729
3/4	11	0.070	0.8025	0.8222	4 1/2	2 3/4	0.250	4.6202	4.6989
3/4	12	0.070	0.8157	0.8337	4 3/4	2 5/8	0.250	4.8402	4.9227
13/16	9	0.070	0.8300	0.8541	5	2 1/2	0.250	5.0572	5.1438
1 1/8	10	0.070	0.8493	0.8710

Buckingham Simplified Formula which Includes Effect of Lead Angle.—The **Formula (3)** which follows gives very accurate results for the lower lead angles in determining measurement *M*. However, if extreme accuracy is essential, it may be advisable to use the involute helicoid formulas as explained later.

$$M = E + W(1 + \sin A_n) \quad (3) \quad \text{where} \quad W = \frac{T \times \cos B}{\cos A_n} \quad (3a)$$

Theoretically correct equations for determining measurement *M* are complex and cumbersome to apply. **Formula (3)** combines simplicity with a degree of accuracy which meets all but the most exacting requirements, particularly for lead angles below 8 or 10 degrees and the higher thread angles. However, the wire diameter used in **Formula (3)** must conform to that obtained by **Formula (3a)** to permit a direct solution or one not involving indeterminate equations and successive trials.

Application of Buckingham Formula: In the application of **Formula (3)** to screw or worm threads, two general cases are to be considered.

Case 1: The screw thread or worm is to be milled with a cutter having an included angle equal to the nominal or standard thread angle that is assumed to be the angle in the axial plane. For example, a 60-degree cutter is to be used for milling a thread. In this case, the

Table for Measuring Whitworth Standard Threads by the Three-wire Method

Dia. of Thread	No. of Threads per Inch	Dia. of Wire Used	Dia. Measured over Wires	Dia. of Thread	No. of Threads per Inch	Dia. of Wire Used	Dia. Measured over Wires
$\frac{1}{8}$	40	0.018	0.1420	$2\frac{1}{4}$	4	0.150	2.3247
$\frac{3}{16}$	24	0.030	0.2158	$2\frac{3}{8}$	4	0.150	2.4497
$\frac{1}{4}$	20	0.035	0.2808	$2\frac{1}{2}$	4	0.150	2.5747
$\frac{5}{16}$	18	0.040	0.3502	$2\frac{5}{8}$	4	0.150	2.6997
$\frac{3}{8}$	16	0.040	0.4015	$2\frac{3}{4}$	$3\frac{1}{2}$	0.200	2.9257
$\frac{7}{16}$	14	0.050	0.4815	$2\frac{7}{8}$	$3\frac{1}{2}$	0.200	3.0507
$\frac{1}{2}$	12	0.050	0.5249	3	$3\frac{1}{2}$	0.200	3.1757
$\frac{9}{16}$	12	0.050	0.5874	$3\frac{1}{8}$	$3\frac{1}{2}$	0.200	3.3007
$\frac{5}{8}$	11	0.070	0.7011	$3\frac{1}{4}$	$3\frac{1}{4}$	0.200	3.3905
$\frac{11}{16}$	11	0.070	0.7636	$3\frac{3}{8}$	$3\frac{1}{4}$	0.200	3.5155
$\frac{3}{4}$	10	0.070	0.8115	$3\frac{1}{2}$	$3\frac{1}{4}$	0.200	3.6405
$\frac{13}{16}$	10	0.070	0.8740	$3\frac{5}{8}$	$3\frac{1}{4}$	0.200	3.7655
$\frac{7}{8}$	9	0.070	0.9187	$3\frac{3}{4}$	3	0.200	3.8495
$\frac{15}{16}$	9	0.070	0.9812	$3\frac{7}{8}$	3	0.200	3.9745
1	8	0.090	1.0848	4	3	0.200	4.0995
$1\frac{1}{16}$	8	0.090	1.1473	$4\frac{1}{8}$	3	0.200	4.2245
$1\frac{1}{8}$	7	0.090	1.1812	$4\frac{1}{4}$	$2\frac{7}{8}$	0.250	4.4846
$1\frac{3}{16}$	7	0.090	1.2437	$4\frac{3}{8}$	$2\frac{7}{8}$	0.250	4.6096
$1\frac{1}{4}$	7	0.090	1.3062	$4\frac{1}{2}$	$2\frac{7}{8}$	0.250	4.7346
$1\frac{5}{16}$	7	0.090	1.3687	$4\frac{5}{8}$	$2\frac{7}{8}$	0.250	4.8596
$1\frac{3}{8}$	6	0.120	1.4881	$4\frac{3}{4}$	$2\frac{3}{4}$	0.250	4.9593
$1\frac{7}{16}$	6	0.120	1.5506	$4\frac{7}{8}$	$2\frac{3}{4}$	0.250	5.0843
$1\frac{1}{2}$	6	0.120	1.6131	5	$2\frac{3}{4}$	0.250	5.2093
$1\frac{9}{16}$	6	0.120	1.6756	$5\frac{1}{8}$	$2\frac{3}{4}$	0.250	5.3343
$1\frac{5}{8}$	5	0.120	1.6847	$5\frac{1}{4}$	$2\frac{5}{8}$	0.250	5.4316
$1\frac{11}{16}$	5	0.120	1.7472	$5\frac{3}{8}$	$2\frac{5}{8}$	0.250	5.5566
$1\frac{3}{4}$	5	0.120	1.8097	$5\frac{1}{2}$	$2\frac{5}{8}$	0.250	5.6816
$1\frac{13}{16}$	5	0.120	1.8722	$5\frac{5}{8}$	$2\frac{5}{8}$	0.250	5.8066
$1\frac{7}{8}$	$4\frac{1}{2}$	0.150	1.9942	$5\frac{3}{4}$	$2\frac{1}{2}$	0.250	5.9011
$1\frac{15}{16}$	$4\frac{1}{2}$	0.150	2.0567	$5\frac{7}{8}$	$2\frac{1}{2}$	0.250	6.0261
2	$4\frac{1}{2}$	0.150	2.1192	6	$2\frac{1}{2}$	0.250	6.1511
$2\frac{1}{8}$	$4\frac{1}{2}$	0.150	2.2442

All dimensions are given in inches.

thread angle in the plane of the axis will exceed 60 degrees by an amount increasing with the lead angle. This variation from the standard angle may be of little or no practical importance if the lead angle is small or if the mating nut (or teeth in worm gearing) is formed to suit the thread as milled.

Case 2: The screw thread or worm is to be milled with a cutter reduced to whatever normal angle is equivalent to the standard thread angle in the axial plane. For example, a 29-degree Acme thread is to be milled with a cutter having some angle smaller than 29 degrees (the reduction increasing with the lead angle) to make the thread angle standard in the plane of the axis. Theoretically, the milling cutter angle should always be corrected to suit the normal angle; but if the lead angle is small, such correction may be unnecessary.

If the thread is cut in a lathe to the standard angle as measured in the axial plane, Case 2 applies in determining the pin size *W* and the overall measurement *M*.

In solving all problems under Case 1, angle A_n used in **Formulas (3) and (3a)** equals one-half the included angle of the milling cutter.

When Case 2 applies, angle A_n for milled threads also equals one-half the included angle of the cutter, but the cutter angle is reduced and is determined as follows:

$$\tan A_n = \tan A \times \cos B$$

The included angle of the cutter or the normal included angle of the thread groove = $2A_n$. Examples 1 and 2, which follow, illustrate Cases 1 and 2.

✦ *Example 1 (Case 1):* Take, for example, an Acme screw thread that is milled with a cutter having an included angle of 29 degrees; consequently, the angle of the thread exceeds 29 degrees in the axial section.

The outside or major diameter is 3 inches; the pitch, $\frac{1}{2}$ inch; the lead, 1 inch; the number of threads or "starts," 2. Find pin size W and measurement M .

Pitch diameter $E = 2.75$; $T = 0.25$; $L = 1.0$; $A_n = 14.50^\circ$ $\tan A_n = 0.258618$; $\sin A_n = 0.25038$; and $\cos A_n = 0.968148$.

$$\tan B = \frac{1.0}{3.1416 \times 2.75} = 0.115749 \quad B = 6.6025^\circ$$

$$W = \frac{0.25 \times 0.993368}{0.968148} = 0.25651 \text{ inch}$$

$$M = 2.75 + 0.25651 \times (1 + 0.25038) = 3.0707 \text{ inches}$$

Note: This value of M is only 0.0001 inch larger than that obtained by using the very accurate involute helicoid **Formula (4)** discussed on the following page.

✦ *Example 2 (Case 2):* A triple-threaded worm has a pitch diameter of 2.481 inches, pitch of 1.5 inches, lead of 4.5 inches, lead angle of 30 degrees, and nominal thread angle of 60 degrees in the axial plane. Milling cutter angle is to be reduced. $T = 0.75$ inch; $\cos B = 0.866025$; and $\tan A = 0.57735$. Again use **Formula (3)** to see if it is applicable.

$\tan A_n = \tan A \times \cos B = 0.57735 \times 0.866025 = 0.5000$; hence $A_n = 26.565^\circ$, making the included cutter angle 53.13° , thus $\cos A_n = 0.89443$ and $\sin A_n = 0.44721$.

$$W = \frac{0.75 \times 0.866025}{0.89443} = 0.72618 \text{ inch}$$

$$M = 2.481 + 0.72618 \times (1 + 0.44721) = 3.532 \text{ inches}$$

Note: If the value of measurement M is determined by using the following **Formula (4)** it will be found that $M = 3.515 +$ inches; hence the error equals $3.532 - 3.515 = 0.017$ inch approximately, which indicates that **Formula (3)** is not accurate enough here. The application of this simpler **Formula (3)** will depend upon the lead angle and thread angle (as previously explained) and upon the class of work.

Buckingham Exact Involute Helicoid Formula Applied to Screw Threads.—When extreme accuracy is required in finding measurement M for obtaining a given pitch diameter, the equations that follow, although somewhat cumbersome to apply, have the merit of providing a direct and very accurate solution; consequently, they are preferable to the indeterminate equations and successive trial solutions heretofore employed when extreme precision is required. These equations are exact for involute helical gears and, consequently, give theoretically correct results when applied to a screw thread of the involute helicoidal form; they also give very close approximations for threads having intermediate profiles.

Helical Gear Equation Applied to Screw Thread Measurement: In applying the helical gear equations to a screw thread, use either the axial or normal thread angle and the lead angle of the helix. To keep the solution on a practical basis, either thread angle A or A_n , as the case may be, is assumed to equal the cutter angle of a milled thread. Actually, the pro-

file of a milled thread will have some curvature in both axial and normal sections; hence angles A and A_n represent the angular approximations of these slightly curved profiles. The equations that follow give the values needed to solve the screw thread problem as a helical gear problem.

$$M = \frac{2R_b}{\cos G} + W \quad (4)$$

$$\tan F = \frac{\tan A}{\tan B} = \frac{\tan A_n}{\sin B} \quad (4a) \quad R_b = \frac{E}{2} \cos F \quad (4b)$$

$$T_a = \frac{T}{\tan B} \quad (4c) \quad \tan H_b = \cos F \times \tan H \quad (4d)$$

$$\text{inv } G = \frac{T_a}{E} + \text{inv } F + \frac{W}{2R_b \cos H_b} - \frac{\pi}{S} \quad (4e)$$

The tables of involute functions starting on page 110 provide values for angles from 14 to 51 degrees, used for gear calculations. The formula for involute functions on page 109 may be used to extend this table as required.

Example 3: To illustrate the application of **Formula (4)** and the supplementary formulas, assume that the number of starts $S = 6$; pitch diameter $E = 0.6250$; normal thread angle $A_n = 20^\circ$; lead of thread $L = 0.864$ inch; $T = 0.072$; $W = 0.07013$ inch.

$$\tan B = \frac{L}{\pi E} = \frac{0.864}{1.9635} = 0.44003 \quad B = 23.751^\circ$$

$$\text{Helix angle } H = 90^\circ - 23.751^\circ = 66.249^\circ$$

$$\tan F = \frac{\tan A_n}{\sin B} = \frac{0.36397}{0.40276} = 0.90369 \quad F = 42.104^\circ$$

$$R_b = \frac{E}{2} \cos F = \frac{0.6250}{2} \times 0.74193 = 0.23185$$

$$T_a = \frac{T}{\tan B} = \frac{0.072}{0.44003} = 0.16362$$

$$\tan H_b = \cos F \tan H = 0.74193 \times 2.27257 = 1.68609 \quad H_b = 59.328^\circ$$

The involute function of G is found next by **Formula (4e)**.

$$\text{inv } G = \frac{0.16362}{0.625} + 0.16884 + \frac{0.07013}{2 \times 0.23185 \times 0.51012} - \frac{3.1416}{6} = 0.20351$$

Since 0.20351 is outside the values for involute functions given in the tables on pages 110 through 113 use the formula for involute functions on page 109 to extend these tables as required. It will be found that 44 deg. 21 min. or 44.350 degrees is the angular equivalent of 0.20351; hence, $G = 44.350$ degrees.

$$M = \frac{2R_b}{\cos G} + W = \frac{2 \times 0.23185}{0.71508} + 0.07013 = 0.71859 \text{ inch}$$

Accuracy of Formulas (3) and (4) Compared.—With the involute helicoid **Formula (4)** any wire size that makes contact with the flanks of the thread may be used; however, in the preceding example, the wire diameter W was obtained by **Formula (3a)** in order to compare **Formula (4)** with (3). If **Example (3)** is solved by **Formula (3)**, $M = 0.71912$; hence the difference between the values of M obtained with **Formulas (3) and (4)** equals $0.71912 - 0.71859 = 0.00053$ inch. The included thread angle in this case is 40 degrees. If **Formulas**

(3) and (4) are applied to a 29-degree thread, the difference in measurements M or the error resulting from the use of Formulas (3) will be larger. For example, with an Acme thread having a lead angle of about 34 degrees, the difference in values of M obtained by the two formulas equals 0.0008 inch.

Three-wire Measurement of Acme and Stub Acme Thread Pitch Diameter.—For single- and multiple-start Acme and Stub Acme threads having lead angles of less than 5 degrees, the approximate three-wire formula given on page 1898 and the best wire size taken from the table on page 1907 may be used.

Multiple-start Acme and Stub Acme threads commonly have a lead angle of greater than 5 degrees. For these, a direct determination of the actual pitch diameter is obtained by using the formula: $E = M - (C + c)$ in conjunction with the table on page 1908. To enter the table, the lead angle B of the thread to be measured must be known. It is found by the formula: $\tan B = L \div 3.1416E_1$ where L is the lead of the thread and E_1 is the nominal pitch diameter. The best wire size is now found by taking the value of w_1 as given in the table for lead angle B , with interpolation, and dividing it by the number of threads per inch. The value of $(C + c)_1$ given in the table for lead angle B is also divided by the number of threads per inch to get $(C + c)$. Using the best size wires, the actual measurement over wires M is made and the actual pitch diameter E found by using the formula: $E = M - (C + c)$.

Example: For a 5 tpi, 4-start Acme thread with a 13.952° lead angle, using three 0.10024-inch wires, $M = 1.1498$ inches, hence $E = 1.1498 - 0.1248 = 1.0250$ inches.

Under certain conditions, a wire may contact one thread flank at two points, and it is then advisable to substitute balls of the same diameter as the wires.

Checking Thickness of Acme Screw Threads.—In some instances it may be preferable to check the thread thickness instead of the pitch diameter, especially if there is a thread thickness tolerance.

A direct method, applicable to the larger pitches, is to use a vernier gear-tooth caliper for measuring the thickness in the *normal* plane of the thread. This measurement, for an American Standard General Purpose Acme thread, should be made at a distance below the *basic* outside diameter equal to $p/4$. The thickness at this basic pitch-line depth and in the axial plane should be $p/2 - 0.259 \times$ the pitch diameter allowance from the table on page 1828 with a tolerance of *minus* $0.259 \times$ the pitch diameter tolerance from the table on page 1833. The thickness in the normal plane or plane of measurement is equal to the thickness in the axial plane multiplied by the cosine of the helix angle. The helix angle may be determined from the formula:

$$\text{tangent of helix angle} = \text{lead of thread} \div (3.1416 \times \text{pitch diameter})$$

Three-Wire Method for Checking Thickness of Acme Threads.—The application of the 3-wire method of checking the thickness of an Acme screw thread is included in the Report of the National Screw Thread Commission. In applying the 3-wire method for checking thread thickness, the procedure is the same as in checking pitch diameter (see *Three-wire Measurement of Acme and Stub Acme Thread Pitch Diameter*), although a different formula is required. Assume that D = basic major diameter of screw; M = measurement over wires; W = diameter of wires; S = tangent of helix angle at pitch line; P = pitch; T = thread thickness at depth equal to $0.25P$.

$$T = 1.12931 \times P + 0.25862 \times (M - D) - W \times (1.29152 + 0.48407S^2)$$

This formula transposed to show the correct measurement M equivalent to a given required thread thickness is as follows:

$$M = D + \frac{W \times (1.29152 + 0.48407S^2) + T - 1.12931 \times P}{0.25862}$$

**Wire Sizes for Three-Wire Measurement of Acme Threads
 with Lead Angles of Less than 5 Degrees**

Threads per Inch	Best Size	Max.	Min.	Threads per Inch	Best Size	Max.	Min.
1	0.51645	0.65001	0.48726	5	0.10329	0.13000	0.09745
1½	0.38734	0.48751	0.36545	6	0.08608	0.10834	0.08121
1½	0.34430	0.43334	0.32484	8	0.06456	0.08125	0.06091
2	0.25822	0.32501	0.24363	10	0.05164	0.06500	0.04873
2½	0.20658	0.26001	0.19491	12	0.04304	0.05417	0.04061
3	0.17215	0.21667	0.16242	14	0.03689	0.04643	0.03480
4	0.12911	0.16250	0.12182	16	0.03228	0.04063	0.03045

Wire sizes are based upon zero helix angle. Best size = 0.51645 × pitch; maximum size = 0.650013 × pitch; minimum size = 0.487263 × pitch.

Example: An Acme General Purpose thread, Class 2G, has a 5-inch basic major diameter, 0.5-inch pitch, and 1-inch lead (double thread). Assume the wire size is 0.258 inch. Determine measurement *M* for a thread thickness *T* at the basic pitch line of 0.2454 inch. (*T* is the maximum thickness at the basic pitch line and equals 0.5*P*, the basic thickness, -0.259 × allowance from Table 4, page 1833.)

$$M = 5 + \frac{0.258 \times [1.29152 + 0.48407 \times (0.06701)^2] + 0.2454 - 1.12931 \times 0.5}{0.25862}$$

$$= 5.056 \text{ inches}$$

Testing Angle of Thread by Three-Wire Method.—The error in the angle of a thread may be determined by using sets of wires of two diameters, the measurement over the two sets of wires being followed by calculations to determine the amount of error, assuming that the angle cannot be tested by comparison with a standard plug gage, known to be correct. The diameter of the small wires for the American Standard thread is usually about 0.6 times the pitch and the diameter of the large wires, about 0.9 times the pitch. The total difference between the measurements over the large and small sets of wires is first determined. If the thread is an American Standard or any other form having an included angle of 60 degrees, the difference between the two measurements should equal three times the difference between the diameters of the wires used. Thus, if the wires are 0.116 and 0.076 inch in diameter, respectively, the difference equals 0.116 - 0.076 = 0.040 inch. Therefore, the difference between the micrometer readings for a standard angle of 60 degrees equals 3 × 0.040 = 0.120 inch for this example. If the angle is incorrect, the amount of error may be determined by the following formula, which applies to any thread regardless of angle:

$$\sin a = \frac{A}{B - A}$$

where *A* = difference in diameters of the large and small wires used

B = total difference between the measurements over the large and small wires

a = one-half the included thread angle

Example: The diameter of the large wires used for testing the angle of a thread is 0.116 inch and of the small wires 0.076 inch. The measurement over the two sets of wires shows a total difference of 0.122 inch instead of the correct difference, 0.120 inch, for a standard angle of 60 degrees when using the sizes of wires mentioned. The amount of error is determined as follows:

$$\sin a = \frac{0.040}{0.122 - 0.040} = \frac{0.040}{0.082} = 0.4878$$

A table of sines shows that this value (0.4878) is the sine of 29 degrees 12 minutes, approximately. Therefore, the angle of the thread is 58 degrees 24 minutes or 1 degree 36 minutes less than the standard angle.

Best Wire Diameters and Constants for Three-wire Measurement of Acme and Stub Acme Threads with Large Lead Angles, 1-inch Axial Pitch

Lead angle, B , deg.	1-start threads		2-start threads		Lead angle, B , deg.	2-start threads		3-start threads	
	w_1	$(C + c)_1$	w_1	$(C + c)_1$		w_1	$(C + c)_1$	w_1	$(C + c)_1$
5.0	0.51450	0.64311	0.51443	0.64290	10.0	0.50864	0.63518	0.50847	0.63463
5.1	0.51442	0.64301	0.51435	0.64279	10.1	0.50849	0.63498	0.50381	0.63442
5.2	0.51435	0.64291	0.51427	0.64268	10.2	0.50834	0.63478	0.50815	0.63420
5.3	0.51427	0.64282	0.51418	0.64256	10.3	0.50818	0.63457	0.50800	0.63399
5.4	0.51419	0.64272	0.51410	0.64245	10.4	0.50802	0.63436	0.50784	0.63378
5.5	0.51411	0.64261	0.51401	0.64233	10.5	0.40786	0.63416	0.50768	0.63356
5.6	0.51403	0.64251	0.51393	0.64221	10.6	0.50771	0.63395	0.50751	0.63333
5.7	0.51395	0.64240	0.51384	0.64209	10.7	0.50755	0.63375	0.50735	0.63311
5.8	0.51386	0.64229	0.51375	0.64196	10.8	0.50739	0.63354	0.50718	0.63288
5.9	0.51377	0.64218	0.51366	0.64184	10.9	0.50723	0.63333	0.50701	0.63265
6.0	0.51368	0.64207	0.51356	0.64171	11.0	0.50707	0.63313	0.50684	0.63242
6.1	0.51359	0.64195	0.51346	0.64157	11.1	0.50691	0.63292	0.50667	0.63219
6.2	0.51350	0.64184	0.51336	0.64144	11.2	0.50674	0.63271	0.50649	0.63195
6.3	0.51340	0.64172	0.41327	0.64131	11.3	0.50658	0.63250	0.50632	0.63172
6.4	0.51330	0.64160	0.51317	0.64117	11.4	0.50641	0.63228	0.50615	0.63149
6.5	0.51320	0.64147	0.51306	0.64103	11.5	0.50623	0.63206	0.50597	0.63126
6.6	0.51310	0.64134	0.51296	0.64089	11.6	0.50606	0.63184	0.50579	0.63102
6.7	0.51300	0.64122	0.51285	0.64075	11.7	0.50589	0.63162	0.50561	0.63078
6.8	0.51290	0.64110	0.51275	0.64061	11.8	0.50571	0.63140	0.50544	0.63055
6.9	0.51280	0.64097	0.51264	0.64046	11.9	0.50553	0.63117	0.50526	0.63031
7.0	0.51270	0.64085	0.51254	0.64032	12.0	0.50535	0.63095	0.50507	0.63006
7.1	0.51259	0.64072	0.51243	0.64017	12.1	0.50517	0.63072	0.50488	0.62981
7.2	0.51249	0.64060	0.51232	0.64002	12.2	0.50500	0.63050	0.50470	0.62956
7.3	0.51238	0.64047	0.51221	0.63987	12.3	0.50482	0.63027	0.50451	0.62931
7.4	0.51227	0.64034	0.51209	0.63972	12.4	0.50464	0.63004	0.50432	0.62906
7.5	0.51217	0.64021	0.51198	0.63957	12.5	0.50445	0.62981	0.50413	0.62881
7.6	0.51206	0.64008	0.51186	0.63941	12.6	0.50427	0.62958	0.50394	0.62856
7.7	0.51196	0.63996	0.51174	0.63925	12.7	0.50408	0.62934	0.50375	0.62830
7.8	0.51186	0.63983	0.51162	0.63909	12.8	0.50389	0.62911	0.50356	0.62805
7.9	0.51175	0.63970	0.51150	0.63892	12.9	0.50371	0.62888	0.50336	0.62779
8.0	0.51164	0.63957	0.51138	0.63876	13.0	0.50352	0.62865		
8.1	0.51153	0.63944	0.51125	0.63859	13.1	0.50333	0.62841		
8.2	0.51142	0.63930	0.51113	0.63843	13.2	0.50313	0.62817		
8.3	0.51130	0.63916	0.51101	0.63827	13.3	0.50293	0.62792		
8.4	0.51118	0.63902	0.51088	0.63810	13.4	0.50274	0.62778		
8.5	0.51105	0.63887	0.51075	0.63793	13.5	0.50254	0.62743		
8.6	0.51093	0.63873	0.51062	0.63775	13.6	0.50234	0.62718		
8.7	0.51081	0.63859	0.51049	0.63758	13.7	0.50215	0.62694		
8.8	0.51069	0.63845	0.51035	0.63740	13.8	0.50195	0.62670		
8.9	0.51057	0.63831	0.51022	0.63722	13.9	0.50175	0.62645		
9.0	0.51044	0.63817	0.51008	0.63704	14.0	0.50155	0.62621		
9.1	0.51032	0.63802	0.50993	0.63685	14.1	0.50135	0.62596		
9.2	0.51019	0.63788	0.50979	0.63667	14.2	0.50115	0.62571		
9.3	0.51006	0.63774	0.50965	0.63649	14.3	0.50094	0.62546		
9.4	0.50993	0.63759	0.50951	0.63630	14.4	0.50073	0.62520		
9.5	0.50981	0.63744	0.50937	0.63612	14.5	0.50051	0.62494		
9.6	0.50968	0.63730	0.50922	0.63593	14.6	0.50030	0.62468		
9.7	0.50955	0.63715	0.50908	0.63574	14.7	0.50009	0.62442		
9.8	0.50941	0.63700	0.50893	0.63555	14.8	0.49988	0.62417		
9.9	0.50927	0.63685	0.50879	0.63537	14.9	0.49966	0.62391		
10.0	0.50913	0.63670	0.50864	0.63518	15.0	0.49945	0.62365		

For these
3-start
thread
values
see
table
on
following
page.

All dimensions are in inches.

Values given for w_1 and $(C + c)_1$ in table are for 1-inch pitch axial threads. For other pitches, divide table values by number of threads per inch.

Courtesy of Van Keuren Co.

Best Wire Diameters and Constants for Three-wire Measurement of Acme and Stub Acme Threads with Large Lead Angles—1-inch Axial Pitch

Lead angle, B , deg.	3-start threads		4-start threads		Lead angle, B , deg.	3-start threads		4-start threads	
	w_1	$(C + c)_1$	w_1	$(C + c)_1$		w_1	$(C + c)_1$	w_1	$(C + c)_1$
13.0	0.50316	0.62752	0.50297	0.62694	18.0	0.49154	0.61250	0.49109	0.61109
13.1	0.50295	0.62725	0.50277	0.62667	18.1	0.49127	0.61216	0.49082	0.61073
13.2	0.50275	0.62699	0.50256	0.62639	18.2	0.49101	0.61182	0.49054	0.61037
13.3	0.50255	0.62672	0.50235	0.62611	18.3	0.49074	0.61148	0.49027	0.61001
13.4	0.50235	0.62646	0.50215	0.62583	18.4	0.49047	0.61114	0.48999	0.60964
13.5	0.50214	0.62619	0.50194	0.62555	18.5	0.49020	0.61080	0.48971	0.60928
13.6	0.50194	0.62592	0.50173	0.62526	18.6	0.48992	0.61045	0.48943	0.60981
13.7	0.50173	0.62564	0.50152	0.62498	18.7	0.48965	0.61011	0.48915	0.60854
13.8	0.50152	0.62537	0.50131	0.62469	18.8	0.48938	0.60976	0.48887	0.60817
13.9	0.50131	0.62509	0.50109	0.62440	18.9	0.48910	0.60941	0.48859	0.60780
14.0	0.50110	0.62481	0.50087	0.62411	19.0	0.48882	0.60906	0.48830	0.60742
14.1	0.50089	0.62453	0.50065	0.62381	19.1	0.48854	0.60871	0.48800	0.60704
14.2	0.50068	0.62425	0.50043	0.62351	19.2	0.48825	0.60835	0.48771	0.60666
14.3	0.50046	0.62397	0.50021	0.62321	19.3	0.48797	0.60799	0.48742	0.60628
14.4	0.50024	0.62368	0.49999	0.62291	19.4	0.48769	0.60764	0.48713	0.60590
14.5	0.50003	0.62340	0.49977	0.62262	19.5	0.48741	0.60729	0.48684	0.60552
14.6	0.49981	0.62312	0.49955	0.62232	19.6	0.48712	0.60693	0.48655	0.60514
14.7	0.49959	0.62283	0.49932	0.62202	19.7	0.48683	0.60657	0.48625	0.60475
14.8	0.49936	0.62253	0.49910	0.62172	19.8	0.48655	0.60621	0.48596	0.60437
14.9	0.49914	0.62224	0.49887	0.62141	19.9	0.48626	0.60585	0.48566	0.60398
15.0	0.49891	0.62195	0.49864	0.62110	20.0	0.48597	0.60549	0.48536	0.60359
15.1	0.49869	0.62166	0.49842	0.62080	20.1	0.48506	0.60320
15.2	0.49846	0.62137	0.49819	0.62049	20.2	0.48476	0.60281
15.3	0.49824	0.62108	0.49795	0.62017	20.3	0.48445	0.60241
15.4	0.42801	0.62078	0.49771	0.61985	20.4	0.48415	0.60202
15.5	0.49778	0.62048	0.49747	0.61953	20.5	0.48384	0.60162
15.6	0.49754	0.62017	0.49723	0.61921	20.6	0.48354	0.60123
15.7	0.49731	0.61987	0.49699	0.61889	20.7	0.48323	0.60083
15.8	0.49707	0.61956	0.49675	0.61857	20.8	0.48292	0.60042
15.9	0.49683	0.61926	0.49651	0.61825	20.9	0.48261	0.60002
16.0	0.49659	0.61895	0.49627	0.61793	21.0	0.48230	0.59961
16.1	0.49635	0.61864	0.49602	0.61760	21.1	0.48198	0.49920
16.2	0.49611	0.61833	0.49577	0.61727	21.2	0.48166	0.59879
16.3	0.49586	0.61801	0.49552	0.61694	21.3	0.48134	0.59838
16.4	0.49562	0.61770	0.49527	0.61661	21.4	0.48103	0.59797
16.5	0.49537	0.61738	0.49502	0.61628	21.5	0.48071	0.59756
16.6	0.49512	0.61706	0.49476	0.61594	21.6	0.48040	0.59715
16.7	0.49488	0.61675	0.49451	0.61560	21.7	0.48008	0.59674
16.8	0.40463	0.61643	0.49425	0.61526	21.8	0.47975	0.59632
16.9	0.49438	0.61611	0.49400	0.61492	21.9	0.47943	0.59590
17.0	0.49414	0.61580	0.49375	0.61458	22.0	0.47910	0.59548
17.1	0.49389	0.61548	0.49349	0.61424	22.1	0.47878	0.59507
17.2	0.49363	0.61515	0.49322	0.61389	22.2	0.47845	0.59465
17.3	0.49337	0.61482	0.49296	0.61354	22.3	0.47812	0.59422
17.4	0.49311	0.61449	0.49269	0.61319	22.4	0.47778	0.59379
17.5	0.49285	0.61416	0.49243	0.61284	22.5	0.47745	0.59336
17.6	0.49259	0.61383	0.49217	0.61250	22.6	0.47711	0.52993
17.7	0.49233	0.61350	0.49191	0.61215	22.7	0.47677	0.59250
17.8	0.49206	0.61316	0.49164	0.61180	22.8	0.47643	0.59207
17.9	0.49180	0.61283	0.49137	0.61144	22.9	0.47610	0.59164
...	23.0	0.47577	0.59121

All dimensions are in inches.

Values given for w_1 and $(C + c)_1$ in table are for 1-inch pitch axial threads. For other pitches divide table values by number of threads per inch.

Courtesy of Van Keuren Co.

Measuring Taper Screw Threads by Three-Wire Method.—When the 3-wire method is used in measuring a taper screw thread, the measurement is along a line that is not perpendicular to the axis of the screw thread, the inclination from the perpendicular equaling one-half the included angle of the taper. The formula that follows compensates for this inclination resulting from contact of the measuring instrument surfaces, with two wires on one side and one on the other. The taper thread is measured over the wires in the usual manner except that the single wire must be located in the thread at a point where the effective diameter is to be checked (as described more fully later). The formula shows the dimension equivalent to the correct pitch diameter at this given point. The general formula for taper screw threads follows:

$$M = \frac{E - (\cot a)/2N + W(1 + \csc a)}{\sec b}$$

where M = measurement over the 3 wires

E = pitch diameter

a = one-half the angle of the thread

N = number of threads per inch

W = diameter of wires; and

b = one-half the angle of taper.

This formula is not theoretically correct but it is accurate for screw threads having tapers of $\frac{3}{4}$ inch per foot or less. This general formula can be simplified for a given thread angle and taper. The simplified formula following (in which P = pitch) is for an American National Standard pipe thread:

$$M = \frac{E - (0.866025 \times P) + 3 \times W}{1.00049}$$

Standard pitch diameters for pipe threads will be found in the section "American Pipe Threads," which also shows the location, or distance, of this pitch diameter from the end of the pipe. In using the formula for finding dimension M over the wires, the single wire is placed in whatever part of the thread groove locates it at the point where the pitch diameter is to be checked. The wire must be accurately located at this point. The other wires are then placed on each side of the thread that is diametrically opposite the single wire. If the pipe thread is straight or without taper,

$$M = E - (0.866025 \times P) + 3 \times W$$

Application of Formula to Taper Pipe Threads: To illustrate the use of the formula for taper threads, assume that dimension M is required for an American Standard 3-inch pipe thread gage. Table 1a starting on page 1862 shows that the 3-inch size has 8 threads per inch, or a pitch of 0.125 inch, and a pitch diameter at the gaging notch of 3.3885 inches. Assume that the wire diameter is 0.07217 inch: Then when the pitch diameter is correct

$$M = \frac{3.3885 - (0.866025 \times 0.125) + 3 \times 0.07217}{1.00049} = 3.495 \text{ inches}$$

Pitch Diameter Equivalent to a Given Measurement Over the Wires: The formula following may be used to check the pitch diameter at any point along a tapering thread when measurement M over wires of a given diameter is known. In this formula, E = the effective or pitch diameter at the position occupied by the single wire. The formula is not theoretically correct but gives very accurate results when applied to tapers of $\frac{3}{4}$ inch per foot or less.

$$E = 1.00049 \times M + (0.866025 \times P) - 3 \times W$$

Example: Measurement $M = 3.495$ inches at the gaging notch of a 3-inch pipe thread and the wire diameter = 0.07217 inch. Then

$$E = 1.00049 \times 3.495 + (0.866025 \times 0.125) - 3 \times 0.07217 = 3.3885 \text{ inches}$$

Pitch Diameter at Any Point Along Taper Screw Thread: When the pitch diameter in any position along a tapering thread is known, the pitch diameter at any other position may be determined as follows:

Multiply the distance (measured along the axis) between the location of the known pitch diameter and the location of the required pitch diameter, by the taper per inch or by 0.0625 for American National Standard pipe threads. Add this product to the known diameter, if the required diameter is at a large part of the taper, or subtract if the required diameter is smaller.

Example: The pitch diameter of a 3-inch American National Standard pipe thread is 3.3885 at the gaging notch. Determine the pitch diameter at the small end. The table starting on page 1862 shows that the distance between the gaging notch and the small end of a 3-inch pipe is 0.77 inch. Hence the pitch diameter at the small end = $3.3885 - (0.77 \times 0.0625) = 3.3404$ inches.

Three-Wire Method Applied to Buttress Threads

The angles of buttress threads vary somewhat, especially on the front or load-resisting side. **Formula (1)**, which follows, may be applied to any angles required. In this formula, M = measurement over wires when *pitch diameter* E is correct; A = included angle of front and thread groove; a = angle of front face or load-resisting side, measured from a line perpendicular to screw thread axis; P = pitch of thread; and W = wire diameter.

$$M = E - \left[\frac{P}{\tan a + \tan(A - a)} \right] + W \left[1 + \cos \left(\frac{A}{2} - a \right) \times \csc \frac{A}{2} \right] \quad (1)$$

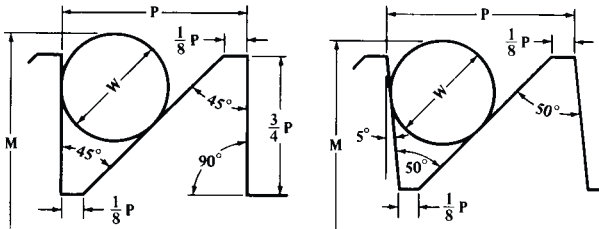

For given angles A and a , this general formula may be simplified as shown by **Formulas (3) and (4)**. These simplified formulas contain constants with values depending upon angles A and a .

Wire Diameter: The wire diameter for obtaining pitch-line contact at the back of a buttress thread may be determined by the following general **Formula (2)**:

$$W = P \left(\frac{\cos a}{1 + \cos A} \right) \quad (2)$$

45-Degree Buttress Thread: The buttress thread shown by the diagram at the left, has a front or load-resisting side that is perpendicular to the axis of the screw. Measurement M equivalent to a correct pitch diameter E may be determined by **Formula (3)**:

$$M = E - P + (W \times 3.4142) \quad (3)$$

Wire diameter W for pitch-line contact at back of thread = $0.586 \times$ pitch.

50-Degree Buttress Thread with Front-face Inclination of 5 Degrees: This buttress thread form is illustrated by the diagram at the right. Measurement M equivalent to the correct pitch diameter E may be determined by **Formula (4)**:

$$M = E - (P \times 0.91955) + (W \times 3.2235) \quad (4)$$

Wire diameter W for pitch-line contact at back of thread = $0.606 \times$ pitch. If the width of flat at crest and root = $\frac{1}{8} \times$ pitch, depth = $0.69 \times$ pitch.

American National Standard Buttress Threads ANSI B1.9-1973: This buttress screw thread has an included thread angle of 52 degrees and a front face inclination of 7 degrees. Measurements M equivalent to a pitch diameter E may be determined by **Formula (5)**:

$$M = E - 0.89064P + 3.15689W + c \quad (5)$$

The wire angle correction factor c is less than 0.0004 inch for recommended combinations of thread diameters and pitches and may be neglected. Use of wire diameter $W = 0.54147P$ is recommended.

Measurement of Pitch Diameter of Thread Ring Gages.—The application of direct methods of measurement to determine the pitch diameter of thread ring gages presents serious difficulties, particularly in securing proper contact pressure when a high degree of precision is required. The usual practice is to fit the ring gage to a master setting plug. When the thread ring gage is of correct lead, angle, and thread form, within close limits, this method is quite satisfactory and represents standard American practice. It is the only method available for small sizes of threads. For the larger sizes, various more or less satisfactory methods have been devised, but none of these have found wide application.

Screw Thread Gage Classification.—Screw thread gages are classified by their degree of accuracy, that is, by the amount of tolerance afforded the gage manufacturer and the wear allowance, if any.

There are also three classifications according to use: 1) Working gages for controlling production; 2) inspection gages for rejection or acceptance of the finished product; and 3) reference gages for determining the accuracy of the working and inspection gages.

American National Standard for Gages and Gaging for Unified Inch Screw Threads ANSI/ASME B1.2-1983 (R2007).—This standard covers gaging methods for conformance of Unified Screw threads and provides the essential specifications for applicable gages required for unified inch screw threads.

The standard includes the following gages for *Product Internal Thread*:

GO Working Thread Plug Gage for inspecting the maximum-material GO functional limit.

NOT GO (HI) Thread Plug Gage for inspecting the NOT GO (HI) functional diameter limit.

Thread Snap Gage—GO Segments or Rolls for inspecting the maximum-material GO functional limit.

Thread Snap Gage—NOT GO (HI) Segments or Rolls for inspecting the NOT GO (HI) functional diameter limit.

Thread Snap Gages—Minimum Material: Pitch Diameter Cone Type and Vee and Thread Groove Diameter Type for inspecting the minimum-material limit pitch diameter.

Thread-Setting Solid Ring Gage for setting internal thread indicating and snap gages.

Plain Plug, Snap, and Indicating Gages for checking the minor diameter of internal threads.

Snap and Indicating Gages for checking the major diameter of internal threads.

Functional Indicating Thread Gage for inspecting the maximum-material GO functional limit and size and the NOT GO (HI) functional diameter limit and size.

Minimum-Material Indicating Thread Gage for inspecting the minimum-material limit and size.

Indicating Runout Thread Gage for inspecting runout of the minor diameter to pitch diameter.

In addition to these gages for product internal threads, the Standard also covers differential gaging and such instruments as pitch micrometers, thread-measuring balls, optical comparator and toolmaker's microscope, profile tracing instrument, surface roughness measuring instrument, and roundness measuring equipment.

The Standard includes the following gages for *Product External Thread*:

GO Working Thread Ring Gage for inspecting the maximum-material GO functional limit.

NOT GO (LO) Thread Ring Gage for inspecting the NOT GO (LO) functional diameter limit.

Thread Snap Gage—GO Segments or Rolls for inspecting the maximum-material GO functional limit.

Thread Snap Gage—NOT GO (LO) Segments or Rolls for inspecting the NOT GO (LO) functional diameter limit.

Thread Snap Gages—Cone and Vee Type and Minimum Material Thread Groove Diameter Type for inspecting the minimum-material pitch diameter limit.

Plain Ring and Snap Gages for checking the major diameter.

Snap Gage for checking the minor diameter.

Functional Indicating Thread Gage for inspecting the maximum-material GO functional limit and size and the NOT GO (LO) functional diameter limit and size.

Minimum-Material Indicating Thread Gage for inspecting the minimum-material limit and size.

Indicating Runout Gage for inspecting the runout of the major diameter to the pitch diameter.

WTolerance Thread-Setting Plug Gage for setting adjustable thread ring gages, checking solid thread ring gages, setting thread snap limit gages, and setting indicating thread gages.

Plain Check Plug Gage for Thread Ring Gage for verifying the minor diameter limits of thread ring gages after the thread rings have been properly set with the applicable thread-setting plug gages.

Indicating Plain Diameter Gage for checking the major diameter.

Indicating Gage for checking the minor diameter.

In addition to these gages for product external threads, the Standard also covers differential gaging and such instruments as thread micrometers, thread-measuring wires, optical comparator and toolmaker's microscope, profile tracing instrument, electromechanical lead tester, helical path attachment used with GO type thread indicating gage, helical path analyzer, surface roughness measuring equipment, and roundness measuring equipment.

The standard lists the following for use of Threaded and Plain Gages for verification of product internal threads:

Tolerance: Unless otherwise specified all thread gages which directly check the product thread shall be X tolerance for all classes.

GO Thread Plug Gages: GO thread plug gages must enter and pass through the full threaded length of the product freely. The GO thread plug gage is a cumulative check of all thread elements except the minor diameter.

NOT GO (HI) Thread Plug Gages: NOT GO (HI) thread plug gages when applied to the product internal thread may engage only the end threads (which may not be representative of the complete thread). Entering threads on product are incomplete and permit gage to start. Starting threads on NOT GO (HI) plugs are subject to greater wear than the remaining threads. Such wear in combination with the incomplete product threads permits further entry of the gage. NOT GO (HI) functional diameter is acceptable when the NOT GO (HI) thread plug gage applied to the product internal thread does not enter more than three complete turns. The gage should not be forced. Special requirements such as exceptionally thin or ductile material, small number of threads, etc., may necessitate modification of this practice.

GO and NOT GO Plain Plug Gages for Minor Diameter of Product Internal Thread: (Recommended in Class Z tolerance.) GO plain plug gages must completely enter and pass through the length of the product without force. NOT GO cylindrical plug gage must not enter.

The standard lists the following for use of Thread Gages for verification of product external threads:

GO Thread Ring Gages: Adjustable GO thread ring gages must be set to the applicable W tolerance setting plugs to assure they are within specified limits. The product thread must freely enter the GO thread ring gage for the entire length of the threaded portion. The GO thread ring gage is a cumulative check of all thread elements except the major diameter.

NOT GO (LO) Thread Ring Gages: NOT GO (LO) thread ring gages must be set to the applicable W tolerance setting plugs to assure that they are within specified limits. NOT GO (LO) thread ring gages when applied to the product external thread may engage only the end threads (which may not be representative of the complete product thread)

Starting threads on NOT GO (LO) rings are subject to greater wear than the remaining threads. Such wear in combination with the incomplete threads at the end of the product thread permit further entry in the gage. NOT GO (LO) functional diameter is acceptable when the NOT GO (LO) thread ring gage applied to the product external thread does not pass over the thread more than three complete turns. The gage should not be forced. Special requirements such as exceptionally thin or ductile material, small number of threads, etc., may necessitate modification of this practice.

GO and NOT GO Plain Ring and Snap Gages for Checking Major Diameter of Product External Thread: The GO gage must completely receive or pass over the major diameter of the product external thread to ensure that the major diameter does not exceed the maximum-material-limit. The NOT GO gage must not pass over the major diameter of the product external thread to ensure that the major diameter is not less than the minimum-material-limit.

Limitations concerning the use of gages are given in the standard as follows:

Product threads accepted by a gage of one type may be verified by other types. It is possible, however, that parts which are near either rejection limit may be accepted by one type and rejected by another. Also, it is possible for two individual limit gages of the same type to be at the opposite extremes of the gage tolerances permitted, and borderline product threads accepted by one gage could be rejected by another. For these reasons, a product screw thread is considered acceptable when it passes a test by any of the permissible gages in ANSI B1.3 for the gaging system that are within the tolerances.

Gaging large product external and internal threads equal to above 6.25-inch nominal size with plain and threaded plug and ring gages presents problems for technical and economic reasons. In these instances, verification may be based on use of modified snap or indicating gages or measurement of thread elements. Various types of gages or measuring

devices in addition to those defined in the Standard are available and acceptable when properly correlated to this Standard. Producer and user should agree on the method and equipment used.

Thread Forms of Gages.—Thread forms of gages for product internal and external threads are given in [Table 1](#). The Standard ANSI/ASME B1.2-1983 (R2007) also gives illustrations of the thread forms of truncated thread setting plug gages, the thread forms of full-form thread setting plug gages, the thread forms of solid thread setting ring gages, and an illustration that shows the chip groove and removal of partial thread.

Building Up Worn Plug Gages.—Plug gages which have been worn under size can be built up by chromium plating and then lapped to size. Any amount of metal up to 0.004 or 0.005 inch can be added to a worn gage. Chromium oxide is used in lapping chromium plated gages, or other parts, to size and for polishing. When the chromium plating of a plug gage has worn under size, it may be removed by subjecting it to the action of muriatic acid. The gage is then built up again by chromium plating and lapped to size. When removing the worn plating the gage should be watched carefully and the action of the acid stopped as soon as the plating has been removed in order to avoid the roughening effect of the acid on the steel.

Thread Gage Tolerances.—Gage tolerances of thread plug and ring gages, thread setting plugs, and setting rings for Unified screw threads, designated as W and X tolerances, are given in [Table 4](#). W tolerances represent the highest commercial grade of accuracy and workmanship, and are specified for thread setting gages; X tolerances are larger than W tolerances and are used for product inspection gages. Tolerances for plain gages are given in [Table 2](#).

Determining Size of Gages: The three-wire method of determining pitch diameter size of plug gages is recommended for gages covered by American National Standard B1.2, described in Appendix B of the 1983 issue of that Standard.

Size limit adjustments of thread ring and external thread snap gages are determined by their fit on their respective calibrated setting plugs. Indicating gages and thread gages for product external threads are controlled by reference to appropriate calibrated setting plugs.

Size limit adjustments of internal thread snap gages are determined by their fit on their respective calibrated setting rings. Indicating gages and other adjustable thread gages for product internal threads are controlled by reference to appropriate calibrated setting rings or by direct measuring methods.

Interpretation of Tolerances: Tolerances on lead, half-angle, and pitch diameter are variations which may be taken independently for each of these elements and may be taken to the extent allowed by respective tabulated dimensional limits. The tabulated tolerance on any one element must not be exceeded, even though variations in the other two elements are smaller than the respective tabulated tolerances.

Direction of Tolerance on Gages: At the maximum-material limit (GO), the dimensions of all gages used for final conformance gaging are to be within limits of size of the product thread. At the functional diameter limit, using NOT GO (HI and LO) thread gages, the standard practice is to have the gage tolerance within the limits of size of the product thread.

Formulas for Limits of Gages: Formulas for limits of American National Standard Gages for Unified screw threads are given in [Table 5](#). Some constants which are required to determine gage dimensions are tabulated in [Table 3](#).

Table 1. Thread Forms of Gages for Product Internal and External Threads

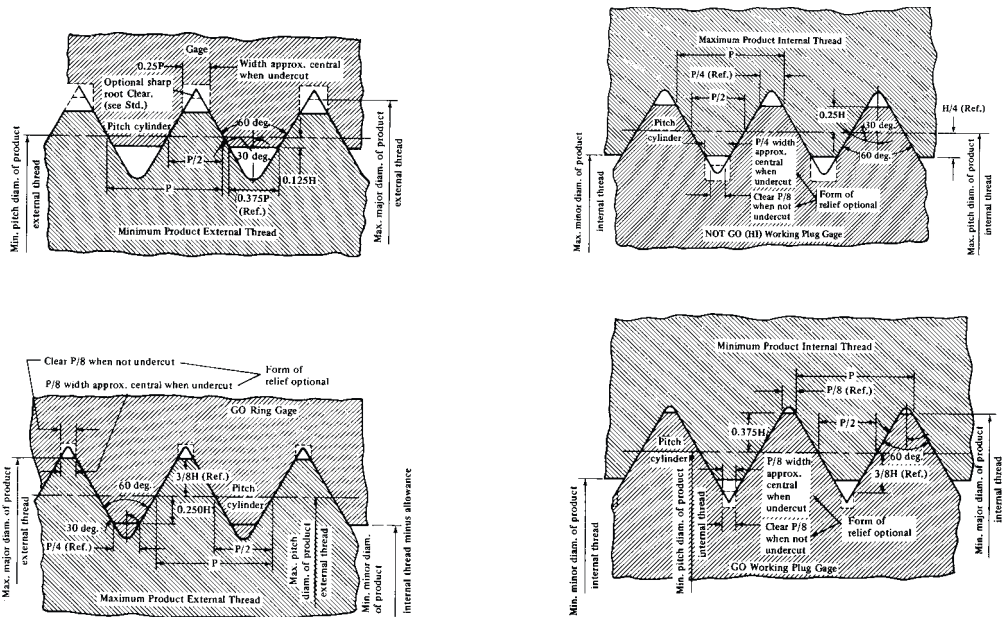

**Table 2. American National Standard Tolerances for Plain Cylindrical Gages
ANSI/ASME B1.2-1983 (R2007)**

Size Range		Tolerance Class ^a				
Above	To and Including	XX	X	Y	Z	ZZ
Tolerance						
0.020	0.825	.00002	.00004	.00007	.00010	.00020
0.825	1.510	.00003	.00006	.00009	.00012	.00024
1.510	2.510	.00004	.00008	.00012	.00016	.00032
2.510	4.510	.00005	.00010	.00015	.00020	.00040
4.510	6.510	.000065	.00013	.00019	.00025	.00050
6.510	9.010	.00008	.00016	.00024	.00032	.00064
9.010	12.010	.00010	.00020	.00030	.00040	.00080

^aTolerances apply to actual diameter of plug or ring. Apply tolerances as specified in the Standard. Symbols XX, X, Y, Z, and ZZ are standard gage tolerance classes.

All dimensions are given in inches.

**Table 3. Constants for Computing Thread Gage Dimensions
ANSI/ASME B1.2-1983 (R2007)**

Threads per Inch	Pitch, p	$0.060\sqrt[3]{p^2} + 0.017p$	$.05p$	$.087p$	Height of Sharp V-Thread, $H = .866025p$	$H/2 = .43301p$	$H/4 = .216506p$
80	.012500	.0034	.00063	.00109	.010825	.00541	.00271
72	.013889	.0037	.00069	.00122	.012028	.00601	.00301
64	.015625	.0040	.00078	.00136	.013532	.00677	.00338
56	.017857	.0044	.00089	.00155	.015465	.00773	.00387
48	.020833	.0049	.00104	.00181	.018042	.00902	.00451
44	.022727	.0052	.00114	.00198	.019682	.00984	.00492
40	.025000	.0056	.00125	.00218	.021651	.01083	.00541
36	.027778	.0060	.00139	.00242	.024056	.01203	.00601
32	.031250	.0065	.00156	.00272	.027063	.01353	.00677
28	.035714	.0071	.00179	.00311	.030929	.01546	.00773
27	.037037	.0073	.00185	.00322	.032075	.01604	.00802
24	.041667	.0079	.00208	.00361	.036084	.01804	.00902
20	.050000	.0090	.00250	.00435	.043301	.02165	.01083
18	.055556	.0097	.00278	.00483	.048113	.02406	.01203
16	.062500	.0105	.00313	.00544	.054127	.02706	.01353
14	.071429	.0115	.00357	.00621	.061859	.03093	.01546
13	.076923	.0122	.00385	.00669	.066617	.03331	.01665
12	.083333	.0129	.00417	.00725	.072169	.03608	.01804
11½	.086957	.0133	.00435	.00757	.075307	.03765	.01883
11	.090909	.0137	.00451	.00791	.078730	.03936	.01968
10	.100000	.0146	.00500	.00870	.086603	.04330	.02165
9	.111111	.0158	.00556	.00967	.096225	.04811	.02406
8	.125000	.0171	.00625	.01088	.108253	.05413	.02706
7	.142857	.0188	.00714	.01243	.123718	.06186	.03093
6	.166667	.0210	.00833	.01450	.144338	.07217	.03608
5	.200000	.0239	.01000	.01740	.173205	.08660	.04330
4½	.222222	.0258	.01111	.01933	.192450	.09623	.04811
4	.250000	.0281	.01250	.02175	.216506	.010825	.05413

All dimensions are given in inches unless otherwise specified.

Table 4. American National Standard Tolerance for GO, HI, and LO Thread Gages for Unified Inch Screw Thread

Thds. per Inch	Tolerance on Lead ^a		Tol. on Thread Half-angle (±), minutes	Tol. on Major and Minor Diams. ^b			Tolerance on Pitch Diameter ^b				
	To & incl. ½ in. Dia.	Above ½ in. Dia.		To & incl. ½ in. Dia.	Above ½ to 4 in. Dia.	Above 4 in. Dia.	To & incl. ½ in. Dia.	Above ½ to 1 ½ in. Dia.	Above 1 ½ to 4 in. Dia.	Above 4 to 8 in. Dia.	Above 8 to 12 in. ^c Dia.
W GAGES											
80, 72	.0001	.00015	20	.0003	.00030001	.00015
64	.0001	.00015	20	.0003	.00040001	.00015
56	.0001	.00015	20	.0003	.00040001	.00015	.0002
48	.0001	.00015	18	.0003	.00040001	.00015	.0002
44, 40	.0001	.00015	15	.0003	.00040001	.00015	.0002
36	.0001	.00015	12	.0003	.00040001	.00015	.0002
32	.0001	.00015	12	.0003	.0005	.0007	.0001	.00015	.0002	.00025	.0003
28, 27	.00015	.00015	8	.0005	.0005	.0007	.0001	.00015	.0002	.00025	.0003
24, 20	.00015	.00015	8	.0005	.0005	.0007	.0001	.00015	.0002	.00025	.0003
18	.00015	.00015	8	.0005	.0005	.0007	.0001	.00015	.0002	.00025	.0003
16	.00015	.00015	8	.0006	.0006	.0009	.0001	.0002	.00025	.0003	.0004
14, 13	.0002	.0002	6	.0006	.0006	.0009	.00015	.0002	.00025	.0003	.0004
12	.0002	.0002	6	.0006	.0006	.0009	.00015	.0002	.00025	.0003	.0004
11½	.0002	.0002	6	.0006	.0006	.0009	.00015	.0002	.00025	.0003	.0004
11	.0002	.0002	6	.0006	.0006	.0009	.00015	.0002	.00025	.0003	.0004
1000025	60006	.00090002	.0025	.0003	.0004
900025	60007	.00110002	.00025	.0003	.0004
800025	50007	.00110002	.00025	.0003	.0004
70003	50007	.00110002	.00025	.0003	.0004
60003	50008	.00130002	.00025	.0003	.0004
50003	40008	.001300025	.0003	.0004
4½0003	40008	.001300025	.0003	.0004
40003	40009	.001500025	.0003	.0004
X GAGES											
80, 72	.0002	.0002	30	.0003	.00030002	.0002
64	.0002	.0002	30	.0004	.00040002	.0002
56, 48	.0002	.0002	30	.0004	.00040002	.0002	.0003
44, 40	.0002	.0002	20	.0004	.00040002	.0002	.0003
36	.0002	.0002	20	.0004	.00040002	.0002	.0003
32, 28	.0003	.0003	15	.0005	.0005	.0007	.0003	.0003	.0004	.0005	.0006
27, 24	.0003	.0003	15	.0005	.0005	.0007	.0003	.0003	.0004	.0005	.0006
20	.0003	.0003	15	.0005	.0005	.0007	.0003	.0003	.0004	.0005	.0006
18	.0003	.0003	10	.0005	.0005	.0007	.0003	.0003	.0004	.0005	.0006
16, 14	.0003	.0003	10	.0006	.0006	.0009	.0003	.0003	.0004	.0006	.0008
13, 12	.0003	.0003	10	.0006	.0006	.0009	.0003	.0003	.0004	.0006	.0008
11½	.0003	.0003	10	.0006	.0006	.0009	.0003	.0003	.0004	.0006	.0008
11, 10	.0003	.0003	10	.0006	.0006	.0009	.0003	.0003	.0004	.0006	.0008
9	.0003	.0003	10	.0007	.0007	.0011	.0003	.0003	.0004	.0006	.0008
8, 7	.0004	.0004	5	.0007	.0007	.0011	.0004	.0004	.0005	.0006	.0008
6	.0004	.0004	5	.0008	.0008	.0013	.0004	.0004	.0005	.0006	.0008
5, 4½	.0004	.0004	5	.0008	.0008	.00130005	.0006	.0008
4	.0004	.0004	5	.0009	.0009	.00150005	.0006	.0008

^a Allowable variation in lead between any two threads not farther apart than the length of the standard gage as shown in ANSI B47.1. The tolerance on lead establishes the width of a zone, measured parallel to the axis of the thread, within which the actual helical path must lie for the specified length of the thread. Measurements are taken from a fixed reference point, located at the start of the first full thread, to a sufficient number of positions along the entire helix to detect all types of lead variations. The amounts that these positions vary from their basic (theoretical) positions are recorded with due respect to sign. The greatest variation in each direction (±) is selected, and the sum of their values, disregarding sign, must not exceed the tolerance limits specified for W gages.

^b Tolerances apply to designated size of thread. The application of the tolerances is specified in the Standard.

^c Above 12 in. the tolerance is directly proportional to the tolerance given in this column below, in the ratio of the diameter to 12 in.

All dimensions are given in inches unless otherwise specified.

Table 5. Formulas for Limits of American National Standard Gages for Unified Inch Screw Threads ANSI/ASME B1.2-1983 (R2007)

No.	Thread Gages for External Threads
1	GO Pitch Diameter = Maximum pitch diameter of external thread. Gage tolerance is <i>minus</i> .
2	GO Minor Diameter = Maximum pitch diameter of external thread minus $H/2$. Gage tolerance is <i>minus</i> .
3	NOT GO (LO) Pitch Diameter (for plus tolerance gage) = Minimum pitch diameter of external thread. Gage tolerance is <i>plus</i> .
4	NOT GO (LO) Minor Diameter = Minimum pitch diameter of external thread minus $H/4$. Gage tolerance is <i>plus</i> .
Plain Gages for Major Diameter of External Threads	
5	GO = Maximum major diameter of external thread. Gage tolerance is <i>minus</i> .
6	NOT GO = Minimum major diameter of external thread. Gage tolerance is <i>plus</i> .
Thread Gages for Internal Threads	
7	GO Major Diameter = Minimum major diameter of internal thread. Gage tolerance is <i>plus</i> .
8	GO Pitch Diameter = Minimum pitch diameter of internal thread. Gage tolerance is <i>plus</i> .
9	NOT GO (HI) Major Diameter = Maximum pitch diameter of internal thread plus $H/2$. Gage tolerance is <i>minus</i> .
10	NOT GO (HI) Pitch Diameter = Maximum pitch diameter of internal thread. Gage tolerance is <i>minus</i> .
Plain Gages for Minor Diameter of Internal Threads	
11	GO = Minimum minor diameter of internal thread. Gage tolerance is <i>plus</i> .
12	NOT GO = Maximum minor diameter of internal thread. Gage tolerance is <i>minus</i> .
Full Form and Truncated Setting Plugs	
13	GO Major Diameter (Truncated Portion) = Maximum major diameter of external thread (= minimum major diameter of full portion of GO setting plug) minus $(0.060\sqrt[3]{p^2} + 0.017p)$. Gage tolerance is <i>minus</i> .
14	GO Major Diameter (Full Portion) = Maximum major diameter of external thread. Gage tolerance is <i>plus</i> .
15	GO Pitch Diameter = Maximum pitch diameter of external thread. Gage tolerance is <i>minus</i> .
16	^a NOT GO (LO) Major Diameter (Truncated Portion) = Minimum pitch diameter of external thread plus $H/2$. Gage tolerance is <i>minus</i> .
17	NOT GO (LO) Major Diameter (Full Portion) = Maximum major diameter of external thread provided major diameter crest width shall not be less than 0.001 in. (0.0009 in. truncation). Apply W tolerance <i>plus</i> for maximum size except that for 0.001 in. crest width apply tolerance <i>minus</i> . For the 0.001 in. crest width, major diameter is equal to maximum major diameter of external thread plus $0.216506p$ minus the sum of external thread pitch diameter tolerance and 0.0017 in.
18	NOT GO (LO) Pitch Diameter = Minimum pitch diameter of external thread. Gage tolerance is <i>plus</i> .
Solid Thread-setting Rings for Snap and Indicating Gages	
19	^b GO Pitch Diameter = Minimum pitch diameter of internal thread. W gage tolerance is <i>plus</i> .
20	GO Minor Diameter = Minimum minor diameter of internal thread. W gage tolerance is <i>minus</i> .
21	^b NOT GO (HI) Pitch Diameter = Maximum pitch diameter of internal thread. W gage tolerance is <i>minus</i> .
22	NOT GO (HI) Minor Diameter = Maximum minor diameter of internal thread. W gage tolerance is <i>minus</i> .

^aTruncated portion is required when optional sharp root profile is used.

^bTolerances greater than W tolerance for pitch diameter are acceptable when internal indicating or snap gage can accommodate a greater tolerance and when agreed upon by supplier and user.

See data in Screw Thread Systems section for symbols and dimensions of Unified Screw Threads.

TAPPING AND THREAD CUTTING

Selection of Taps.—For most applications, a standard tap supplied by the manufacturer can be used, but some jobs may require special taps. A variety of standard taps can be obtained. In addition to specifying the size of the tap it is necessary to be able to select the one most suitable for the application at hand.

The elements of standard taps that are varied are: the number of flutes; the type of flute, whether straight, spiral pointed, or spiral fluted; the chamfer length; the relief of the land, if any; the tool steel used to make the tap; and the surface treatment of the tap.

Details regarding the nomenclature of tap elements are given in the section *TAPS* starting on page 880, along with a listing of the standard sizes available.

Factors to consider in selecting a tap include: the method of tapping, by hand or by machine; the material to be tapped and its heat treatment; the length of thread, or depth of the tapped hole; the required tolerance or class of fit; and the production requirement and the type of machine to be used.

The diameter of the hole must also be considered, although this action is usually only a matter of design and the specification of the tap drill size.

Method of Tapping: The term *hand tap* is used for both hand and machine taps, and almost all taps can be applied by the hand or machine method. While any tap can be used for hand tapping, those having a concentric land without the relief are preferable. In hand tapping the tool is reversed periodically to break the chip, and the heel of the land of a tap with a concentric land (without relief) will cut the chip off cleanly or any portion of it that is attached to the work, whereas a tap with an eccentric or con-eccentric relief may leave a small burr that becomes wedged between the relieved portion of the land and the work. This wedging creates a pressure towards the cutting face of the tap that may cause it to chip; it tends to roughen the threads in the hole, and it increases the overall torque required to turn the tool. When tapping by machine, however, the tap is usually turned only in one direction until the operation is complete, and an eccentric or con-eccentric relief is often an advantage.

Chamfer Length: Three types of hand taps, used both for hand and machine tapping, are available, and they are distinguished from each other by the length of chamfer. *Taper taps* have a chamfer angle that reduces the height about 8–10 teeth; *plug taps* have a chamfer angle with 3–5 threads reduced in height; and *bottoming taps* have a chamfer angle with 1½ threads reduced in height. Since the teeth that are reduced in height do practically all the cutting, the chip load or chip thickness per tooth will be least for a taper tap, greater for a plug tap, and greatest for a bottoming tap.

For most through hole tapping applications it is necessary to use only a plug type tap, which is also most suitable for blind holes where the tap drill hole is deeper than the required thread. If the tap must bottom in a blind hole, the hole is usually threaded first with a plug tap and then finished with a bottoming tap to catch the last threads in the bottom of the hole. Taper taps are used on materials where the chip load per tooth must be kept to a minimum. However, taper taps should not be used on materials that have a strong tendency to work harden, such as the austenitic stainless steels.

Spiral Point Taps: Spiral point taps offer a special advantage when machine tapping through holes in ductile materials because they are designed to handle the long continuous chips that form and would otherwise cause a disposal problem. An angular gash is ground at the point or end of the tap along the face of the chamfered threads or lead teeth of the tap. This gash forms a left-hand helix in the flutes adjacent to the lead teeth which causes the chips to flow ahead of the tap and through the hole. The gash is usually formed to produce a rake angle on the cutting face that increases progressively toward the end of the tool. Since the flutes are used primarily to provide a passage for the cutting fluid, they are usually made narrower and shallower thereby strengthening the tool. For tapping thin work-

pieces short fluted spiral point taps are recommended. They have a spiral point gash along the cutting teeth; the remainder of the threaded portion of the tap has no flute. Most spiral pointed taps are of plug type; however, spiral point bottoming taps are also made.

Spiral Fluted Taps: Spiral fluted taps have a helical flute; the helix angle of the flute may be between 15 and 52 degrees and the hand of the helix is the same as that of the threads on the tap. The spiral flute and the rake that it forms on the cutting face of the tap combine to induce the chips to flow backward along the helix and out of the hole. Thus, they are ideally suited for tapping blind holes and they are available as plug and bottoming types. A higher spiral angle should be specified for tapping very ductile materials; when tapping harder materials, chipping at the cutting edge may result and the spiral angle must be reduced.

Holes having a pronounced interruption such as a groove or a keyway can be tapped with spiral fluted taps. The land bridges the interruption and allows the tap to cut relatively smoothly.

Serial Taps and Close Tolerance Threads: For tapping holes to close tolerances a set of serial taps is used.

They are usually available in sets of three: the No. 1 tap is undersize and is the first rougher; the No. 2 tap is of intermediate size and is the second rougher; and the No. 3 tap is used for finishing.

The different taps are identified by one, two, and three annular grooves in the shank adjacent to the square. For some applications involving finer pitches only two serial taps are required. Sets are also used to tap hard or tough materials having a high tensile strength, deep blind holes in normal materials, and large coarse threads. A set of more than three taps is sometimes required to produce threads of coarse pitch. Threads to some commercial tolerances, such as American Standard Unified 2B, or ISO Metric 6H, can be produced in one cut using a ground tap; sometimes even closer tolerances can be produced with a single tap. Ground taps are recommended for all close tolerance tapping operations. For much ordinary work, cut taps are satisfactory and more economical than ground taps.

Tap Steels: Most taps are made from high speed steel. The type of tool steel used is determined by the tap manufacturer and is usually satisfactory when correctly applied except in a few exceptional cases. Typical grades of high speed steel used to make taps are M-1, M-2, M-3, M-42, etc. Carbon tool steel taps are satisfactory where the operating temperature of the tap is low and where a high resistance to abrasion is not required as in some types of hand tapping.

Surface Treatment: The life of high speed steel taps can sometimes be increased significantly by treating the surface of the tap. A very common treatment is oxide coating, which forms a thin metallic oxide coating on the tap that has lubricity and is somewhat porous to absorb and retain oil. This coating reduces the friction between the tap and the work and it makes the surface virtually impervious to rust. It does not increase the hardness of the surface but it significantly reduces or prevents entirely galling, or the tendency of the work material to weld or stick to the cutting edge and to other areas on the tap with which it is in contact. For this reason oxide coated taps are recommended for metals that tend to gall and stick such as non-free cutting low carbon steels and soft copper. It is also useful for tapping other steels having higher strength properties.

Nitriding provides a very hard and wear resistant case on high speed steel. Nitrided taps are especially recommended for tapping plastics; they have also been used successfully on a variety of other materials including high strength high alloy steels. However, some caution must be used in specifying nitrided taps because the nitride case is very brittle and may have a tendency to chip.

Chrome plating has been used to increase the wear resistance of taps but its application has been limited because of the high cost and the danger of hydrogen embrittlement which can cause cracks to form in the tool. A flash plate of about .0001 in. or less in thickness is applied to the tap. Chrome-plated taps have been used successfully to tap a variety of fer-

rous and nonferrous materials including plastics, hard rubber, mild steel, and tool steel. Other surface treatments that have been used successfully to a limited extent are vapor blasting and liquid honing.

Rake Angle: For the majority of applications in both ferrous and nonferrous materials the rake angle machined on the tap by the manufacturer is satisfactory. This angle is approximately 5 to 7 degrees. In some instances it may be desirable to alter the rake angle of the tap to obtain beneficial results and **Table 1** provides a guide that can be used. In selecting a rake angle from this table, consideration must be given to the size of the tap and the strength of the land. Most standard taps are made with a curved face with the rake angle measured as a chord between the crest and root of the thread. The resulting shape is called a hook angle.

Table 1. Tap Rake Angles for Tapping Different Materials

Material	Rake Angle, Degrees	Material	Rake Angle, Degrees
Cast Iron	0-3	Aluminum	8-20
Malleable Iron	5-8	Brass	2-7
Steel		Naval Brass	5-8
AISI 1100 Series	5-12	Phosphor Bronze	5-12
Low Carbon (up to .25 per cent)	5-12	Tobin Bronze	5-8
Medium Carbon, Annealed (.30 to .60 per cent)	5-10	Manganese Bronze	5-12
Heat Treated, 225-283 Brinell (.30 to .60 per cent)	0-8	Magnesium	10-20
High Carbon and High Speed	0-5	Monel	9-12
Stainless	8-15	Copper	10-18
Titanium	5-10	Zinc Die Castings	10-15
		Plastic	
		Thermoplastic	5-8
		Thermosetting	0-3
		Hard Rubber	0-3

Cutting Speed.—The cutting speed for machine tapping is treated in detail on page 1042. It suffices to say here that many variables must be considered in selecting this cutting speed and any tabulation may have to be modified greatly. Where cutting speeds are mentioned in the following section, they are intended only to provide a guideline to show the possible range of speeds that could be used.

Tapping Specific Materials.—The work material has a great influence on the ease with which a hole can be tapped. For production work, in many instances, modified taps are recommended; however, for toolroom or short batch work, standard hand taps can be used on most jobs, providing reasonable care is taken when tapping. The following concerns the tapping of metallic materials; information on the tapping of plastics is given on page 600.

Low Carbon Steel (Less than 0.15% C): These steels are very soft and ductile resulting in a tendency for the work material to tear and to weld to the tap. They produce a continuous chip that is difficult to break and spiral pointed taps are recommended for tapping through holes; for blind holes a spiral fluted tap is recommended. To prevent galling and welding, a liberal application of a sulfur base or other suitable cutting fluid is essential and the selection of an oxide coated tap is very helpful.

Low Carbon Steels (0.15 to 0.30% C): The additional carbon in these steels is beneficial as it reduces the tendency to tear and to weld; their machinability is further improved by cold drawing. These steels present no serious problems in tapping provided a suitable cutting fluid is used. An oxide coated tap is recommended, particularly in the lower carbon range.

Medium Carbon Steels (0.30 to 0.60% C): These steels can be tapped without too much difficulty, although a lower cutting speed must be used in machine tapping. The cutting speed is dependent on the carbon content and the heat treatment. Steels that have a higher carbon content must be tapped more slowly, especially if the heat treatment has produced a pearlitic microstructure. The cutting speed and ease of tapping is significantly improved by heat treating to produce a spheroidized microstructure. A suitable cutting fluid must be used.

High Carbon Steels (More than 0.6% C): Usually these materials are tapped in the annealed or normalized condition although sometimes tapping is done after hardening and tempering to a hardness below 55 Rc. Recommendations for tapping after hardening and tempering are given under High Tensile Strength Steels. In the annealed and normalized condition these steels have a higher strength and are more abrasive than steels with a lower carbon content; thus, they are more difficult to tap. The microstructure resulting from the heat treatment has a significant effect on the ease of tapping and the tap life, a spheroidite structure being better in this respect than a pearlitic structure. The rake angle of the tap should not exceed 5 degrees and for the harder materials a concentric tap is recommended. The cutting speed is considerably lower for these steels and an activated sulfur-chlorinated cutting fluid is recommended.

Alloy Steels: This classification includes a wide variety of steels, each of which may be heat treated to have a wide range of properties. When annealed and normalized they are similar to medium to high carbon steels and usually can be tapped without difficulty, although for some alloy steels a lower tapping speed may be required. Standard taps can be used and for machine tapping a con-eccentric relief may be helpful. A suitable cutting fluid must be used.

High-Tensile Strength Steels: Any steel that must be tapped after being heat treated to a hardness range of 40–55 Rc is included in this classification. Low tap life and excessive tap breakage are characteristics of tapping these materials; those that have a high chromium content are particularly troublesome. Best results are obtained with taps that have concentric lands, a rake angle that is at or near zero degrees, and 6 to 8 chamfered threads on the end to reduce the chip load per tooth. The chamfer relief should be kept to a minimum. The load on the tap should be kept to a minimum by every possible means, including using the largest possible tap drill size; keeping the hole depth to a minimum; avoidance of bottoming holes; and, in the larger sizes, using fine instead of coarse pitches. Oxide coated taps are recommended although a nitrided tap can sometimes be used to reduce tap wear. An active sulfur-chlorinated oil is recommended as a cutting fluid and the tapping speed should not exceed about 10 feet per minute.

Stainless Steels: Ferritic and martensitic type stainless steels are somewhat like alloy steels that have a high chromium content, and they can be tapped in a similar manner, although a slightly slower cutting speed may have to be used. Standard rake angle oxide coated taps are recommended and a cutting fluid containing molybdenum disulphide is helpful to reduce the friction in tapping. Austenitic stainless steels are very difficult to tap because of their high resistance to cutting and their great tendency to work harden. A work-hardened layer is formed by a cutting edge of the tap and the depth of this layer depends on the severity of the cut and the sharpness of the tool. The next cutting edge must penetrate below the work-hardened layer, if it is to be able to cut. Therefore, the tap must be kept sharp and each succeeding cutting edge on the tool must penetrate below the work-hardened layer formed by the preceding cutting edge. For this reason, a taper tap should not be used, but rather a plug tap having 3–5 chamfered threads. To reduce the rubbing of the lands, an eccentric or con-eccentric relieved land should be used and a 10–15 degree rake angle is recommended. A tough continuous chip is formed that is difficult to break. To control this chip, spiral pointed taps are recommended for through holes and low-helix angle spiral fluted taps for blind holes. An oxide coating on the tap is very helpful and a sulfur-

chlorinated mineral lard oil is recommended, although heavy duty soluble oils have also been used successfully.

Free Cutting Steels: There are large numbers of free cutting steels, including free cutting stainless steels, which are also called free machining steels. Sulfur, lead, or phosphorus are added to these steels to improve their machinability. Free machining steels are always easier to tap than their counterparts that do not have the free machining additives. Tool life is usually increased and a somewhat higher cutting speed can be used. The type of tap recommended depends on the particular type of free machining steel and the nature of the tapping operation; usually a standard tap can be used.

High Temperature Alloys: These are cobalt or nickel base nonferrous alloys that cut like austenitic stainless steel, but are often even more difficult to machine. The recommendations given for austenitic stainless steel also apply to tapping these alloys but the rake angle should be 0 to 10 degrees to strengthen the cutting edge. For most applications a nitrided tap or one made from M41, M42, M43, or M44 steel is recommended. The tapping speed is usually in the range of 5 to 10 feet per minute.

Titanium and Titanium Alloys: Titanium and its alloys have a low specific heat and a pronounced tendency to weld on to the tool material; therefore, oxide coated taps are recommended to minimize galling and welding. The rake angle of the tap should be from 6 to 10 degrees. To minimize the contact between the work and the tap an eccentric or con-eccentric relief land should be used. Taps having interrupted threads are sometimes helpful. Pure titanium is comparatively easy to tap but the alloys are very difficult. The cutting speed depends on the composition of the alloy and may vary from 40 to 10 feet per minute. Special cutting oils are recommended for tapping titanium.

Gray Cast Iron: The microstructure of gray cast iron can vary, even within a single casting, and compositions are used that vary in tensile strength from about 20,000 to 60,000 psi (160 to 250 Bhn). Thus, cast iron is not a single material, although in general it is not difficult to tap. The cutting speed may vary from 90 feet per minute for the softer grades to 30 feet per minute for the harder grades. The chip is discontinuous and straight fluted taps should be used for all applications. Oxide coated taps are helpful and gray cast iron can usually be tapped dry, although water soluble oils and chemical emulsions are sometimes used.

Malleable Cast Iron: Commercial malleable cast irons are also available having a rather wide range of properties, although within a single casting they tend to be quite uniform. They are relatively easy to tap and standard taps can be used. The cutting speed for ferritic cast irons is 60–90 feet per minute, for pearlitic malleable irons 40–50 feet per minute, and for martensitic malleable irons 30–35 feet per minute. A soluble oil cutting fluid is recommended except for martensitic malleable iron where a sulfur base oil may work better.

Ductile or Nodular Cast Iron: Several classes of nodular iron are used having a tensile strength varying from 60,000 to 120,000 psi. Moreover, the microstructure in a single casting and in castings produced at different times vary rather widely. The chips are easily controlled but have some tendency to weld to the faces and flanks of cutting tools. For this reason oxide coated taps are recommended. The cutting speed may vary from 15 fpm for the harder martensitic ductile irons to 60 fpm for the softer ferritic grades. A suitable cutting fluid should be used.

Aluminum: Aluminum and aluminum alloys are relatively soft materials that have little resistance to cutting. The danger in tapping these alloys is that the tap will ream the hole instead of cutting threads, or that it will cut a thread eccentric to the hole. For these reasons, extra care must be taken when aligning the tap and starting the thread. For production tapping a spiral pointed tap is recommended for through holes and a spiral fluted tap for blind holes; preferably these taps should have a 10 to 15 degree rake angle. A lead screw tapping machine is helpful in cutting accurate threads. A heavy duty soluble oil or a light base mineral oil should be used as a cutting fluid.

Copper Alloys: Most copper alloys are not difficult to tap, except beryllium copper and a few other hard alloys. Pure copper is difficult because of its ductility and the ductile continuous chip formed, which can be hard to control. However, with reasonable care and the use of medium heavy duty mineral lard oil it can be tapped successfully. Red brass, yellow brass, and similar alloys containing not more than 35 per cent zinc produce a continuous chip. While straight fluted taps can be used for hand tapping these alloys, machine tapping should be done with spiral pointed or spiral fluted taps for through and blind holes respectively. Naval brass, leaded brass, and cast brasses produce a discontinuous chip and a straight fluted tap can be used for machine tapping. These alloys exhibit a tendency to close in on the tap and sometimes an interrupted thread tap is used to reduce the resulting jamming effect. Beryllium copper and the silicon bronzes are the strongest of the copper alloys. Their strength combined with their ability to work harden can cause difficulties in tapping. For these alloys plug type taps should be used and the taps should be kept as sharp as possible. A medium or heavy duty water soluble oil is recommended as a cutting fluid.

Other Tapping Lubricants.—The power required in tapping varies considerably with different lubricants. The following lubricants reduce the resistance to the cut when threading forged nuts and hexagon drawn material: stearine oil, lard oil, sperm oil, rape oil, and 10 per cent graphite with 90 per cent tallow. A mixture of cutting emulsion (soluble oil) with water reduces resistance to threading action well. A few emulsions are almost as good as animal and vegetable oils, but the emulsion used plays an important part; the majority of emulsions do not give good results. A large volume of lubricant gives somewhat better results than a small quantity, especially in the case of the thinner oils. Kerosene, turpentine, and graphite proved unsuitable for tapping steel. Mineral oils not mixed with animal and vegetable oils, and ordinary lubricating and machine oils, are wholly unsuitable.

For aluminum, kerosene is recommended. For tapping cast iron use a strong solution of emulsion; oil has a tendency to make cast-iron chips clog in the flutes, preventing the lubricant from reaching the tap cutting teeth. For tapping copper, milk is a good lubricant.

Diameter of Tap Drill.—Tapping troubles are sometimes caused by tap drills that are too small in diameter. The tap drill should not be smaller than is necessary to give the required strength to the thread as even a very small decrease in the diameter of the drill will increase the torque required and the possibility of broken taps. Tests have shown that any increase in the percentage of full thread over 60 per cent does not significantly increase the strength of the thread. Often, a 55 to 60 per cent thread is satisfactory, although 75 per cent threads are commonly used to provide an extra measure of safety. The present thread specifications do not always allow the use of the smaller thread depths. However, the specification given on a part drawing must be adhered to and may require smaller minor diameters than might otherwise be recommended.

The depth of the thread in the tapped hole is dependent on the length of thread engagement and on the material. In general, when the engagement length is more than one and one-half times the nominal diameter a 50 or 55 per cent thread is satisfactory. Soft ductile materials permit a slightly larger tapping hole than brittle materials such as gray cast iron.

It must be remembered that a twist drill is a roughing tool that may be expected to drill slightly oversize and that some variations in the size of the tapping holes are almost inevitable. When a closer control of the hole size is required it must be reamed. Reaming is recommended for the larger thread diameters and for some fine pitch threads.

For threads of Unified form (see *American National and Unified Screw Thread Forms* on page 1712) the selection of tap drills is covered in the section *Factors Influencing Minor Diameter Tolerances of Tapped Holes* on page 1935, and the hole size limits are given in **Table 2**. **Tables 3** and **4** give tap drill sizes for American National Form threads based on 75 per cent of full thread depth. For smaller-size threads the use of slightly larger drills, if permissible, will reduce tap breakage. The selection of tap drills for these threads also may be based on the hole size limits given in **Table 2** for Unified threads that take lengths of engagement into account.

Table 2. Recommended Hole Size Limits Before Tapping Unified Threads

Thread Size	Classes 1B and 2B								Class 3B							
	Length of Engagement (D = Nominal Size of Thread)															
	To and Including $\frac{1}{2}D$		Above $\frac{1}{2}D$ to $\frac{3}{4}D$		Above $\frac{3}{4}D$ to $1\frac{1}{2}D$		Above $1\frac{1}{2}D$ to $3D$		To and Including $\frac{1}{2}D$		Above $\frac{1}{2}D$ to $\frac{3}{4}D$		Above $\frac{3}{4}D$ to $1\frac{1}{2}D$		Above $1\frac{1}{2}D$ to $3D$	
	Recommended Hole Size Limits															
Min ^a	Max	Min	Max	Min	Max ^b	Min	Max	Min ^a	Max	Min	Max	Min	Max ^b	Min	Max	
0-80	0.0465	0.0500	0.0479	0.0514	0.0479	0.0514	0.0479	0.0514	0.0465	0.0500	0.0479	0.0514	0.0479	0.0514	0.0479	0.0514
1-64	0.0561	0.0599	0.0585	0.0623	0.0585	0.0623	0.0585	0.0623	0.0561	0.0599	0.0585	0.0623	0.0585	0.0623	0.0585	0.0623
1-72	0.0580	0.0613	0.0596	0.0629	0.0602	0.0635	0.0602	0.0635	0.0580	0.0613	0.0596	0.0629	0.0602	0.0635	0.0602	0.0635
2-56	0.0667	0.0705	0.0686	0.0724	0.0699	0.0737	0.0699	0.0737	0.0667	0.0705	0.0686	0.0724	0.0699	0.0737	0.0699	0.0737
2-64	0.0691	0.0724	0.0707	0.0740	0.0720	0.0753	0.0720	0.0753	0.0691	0.0724	0.0707	0.0740	0.0720	0.0753	0.0720	0.0753
3-48	0.0764	0.0804	0.0785	0.0825	0.0805	0.0845	0.0806	0.0846	0.0764	0.0804	0.0785	0.0825	0.0805	0.0845	0.0806	0.0846
3-56	0.0797	0.0831	0.0814	0.0848	0.0831	0.0865	0.0833	0.0867	0.0797	0.0831	0.0814	0.0848	0.0831	0.0865	0.0833	0.0867
4-40	0.0849	0.0894	0.0871	0.0916	0.0894	0.0939	0.0902	0.0947	0.0849	0.0894	0.0871	0.0916	0.0894	0.0939	0.0902	0.0947
4-48	0.0894	0.0931	0.0912	0.0949	0.0931	0.0968	0.0939	0.0976	0.0894	0.0931	0.0912	0.0949	0.0931	0.0968	0.0939	0.0976
5-40	0.0979	0.1020	0.1000	0.1041	0.1021	0.1062	0.1036	0.1077	0.0979	0.1020	0.1000	0.1041	0.1021	0.1062	0.1036	0.1077
5-44	0.1004	0.1042	0.1023	0.1060	0.1042	0.1079	0.1060	0.1097	0.1004	0.1042	0.1023	0.1060	0.1042	0.1079	0.1060	0.1097
6-32	0.104	0.109	0.106	0.112	0.109	0.114	0.112	0.117	0.104	0.109	0.106	0.112	0.109	0.114	0.112	0.117
6-40	0.111	0.115	0.113	0.117	0.115	0.119	0.117	0.121	0.111	0.115	0.113	0.117	0.115	0.119	0.117	0.121
8-32	0.130	0.134	0.132	0.137	0.134	0.139	0.137	0.141	0.130	0.134	0.132	0.137	0.134	0.139	0.137	0.141
8-36	0.134	0.138	0.136	0.140	0.138	0.142	0.140	0.144	0.134	0.138	0.136	0.140	0.138	0.142	0.140	0.144
10-24	0.145	0.150	0.148	0.154	0.150	0.156	0.152	0.159	0.145	0.150	0.148	0.154	0.150	0.156	0.152	0.159
10-32	0.156	0.160	0.158	0.162	0.160	0.164	0.162	0.166	0.156	0.160	0.158	0.162	0.160	0.164	0.162	0.166
12-24	0.171	0.176	0.174	0.179	0.176	0.181	0.178	0.184	0.171	0.176	0.174	0.179	0.176	0.181	0.178	0.184
12-28	0.177	0.182	0.179	0.184	0.182	0.186	0.184	0.188	0.177	0.182	0.179	0.184	0.182	0.186	0.184	0.188
12-32	0.182	0.186	0.184	0.188	0.186	0.190	0.188	0.192	0.182	0.186	0.184	0.188	0.186	0.190	0.188	0.192
$\frac{1}{4}$ -20	0.196	0.202	0.199	0.204	0.202	0.207	0.204	0.210	0.196	0.202	0.199	0.204	0.202	0.207	0.204	0.210
$\frac{1}{4}$ -28	0.211	0.216	0.213	0.218	0.216	0.220	0.218	0.222	0.211	0.216	0.213	0.218	0.216	0.220	0.218	0.222
$\frac{1}{4}$ -32	0.216	0.220	0.218	0.222	0.220	0.224	0.222	0.226	0.216	0.220	0.218	0.222	0.220	0.224	0.222	0.226
$\frac{1}{4}$ -36	0.220	0.224	0.221	0.225	0.224	0.226	0.225	0.228	0.220	0.224	0.221	0.225	0.224	0.226	0.225	0.228
$\frac{5}{16}$ -18	0.252	0.259	0.255	0.262	0.259	0.265	0.262	0.268	0.252	0.259	0.255	0.262	0.259	0.265	0.262	0.268
$\frac{5}{16}$ -24	0.267	0.272	0.270	0.275	0.272	0.277	0.275	0.280	0.267	0.272	0.270	0.275	0.272	0.277	0.275	0.280
$\frac{5}{16}$ -32	0.279	0.283	0.281	0.285	0.283	0.286	0.285	0.289	0.279	0.283	0.281	0.285	0.283	0.286	0.285	0.289
$\frac{5}{16}$ -36	0.282	0.286	0.284	0.288	0.285	0.289	0.287	0.291	0.282	0.286	0.284	0.288	0.285	0.289	0.287	0.291
$\frac{3}{8}$ -16	0.307	0.314	0.311	0.318	0.314	0.321	0.318	0.325	0.307	0.314	0.311	0.318	0.314	0.321	0.318	0.325

Table 2. (Continued) Recommended Hole Size Limits Before Tapping Unified Threads

Thread Size	Classes 1B and 2B						Class 3B									
	Length of Engagement ($D =$ Nominal Size of Thread)															
	To and Including $\frac{1}{2}D$		Above $\frac{1}{2}D$ to $\frac{2}{3}D$		Above $\frac{2}{3}D$ to $1\frac{1}{2}D$		Above $1\frac{1}{2}D$ to $3D$		To and Including $\frac{1}{2}D$		Above $\frac{1}{2}D$ to $\frac{2}{3}D$		Above $\frac{2}{3}D$ to $1\frac{1}{2}D$		Above $1\frac{1}{2}D$ to $3D$	
	Recommended Hole Size Limits															
	Min ^a	Max	Min	Max	Min	Max ^b	Min	Max	Min ^a	Max	Min	Max	Min	Max ^b	Min	Max
$\frac{3}{8}$ -24	0.330	0.335	0.333	0.338	0.335	0.340	0.338	0.343	0.3300	0.3336	0.3314	0.3354	0.3332	0.3372	0.3351	0.3391
$\frac{3}{8}$ -32	0.341	0.345	0.343	0.347	0.345	0.349	0.347	0.351	0.3410	0.3441	0.3415	0.3455	0.3429	0.3469	0.3444	0.3484
$\frac{3}{8}$ -36	0.345	0.349	0.346	0.350	0.347	0.352	0.349	0.353	0.3450	0.3488	0.3449	0.3488	0.3461	0.3501	0.3474	0.3514
$\frac{7}{16}$ -14	0.360	0.368	0.364	0.372	0.368	0.376	0.372	0.380	0.3600	0.3660	0.3630	0.3688	0.3659	0.3717	0.3688	0.3746
$\frac{7}{16}$ -20	0.383	0.389	0.386	0.391	0.389	0.395	0.391	0.397	0.3830	0.3875	0.3855	0.3896	0.3875	0.3916	0.3896	0.3937
$\frac{7}{16}$ -28	0.399	0.403	0.401	0.406	0.403	0.407	0.406	0.410	0.3990	0.4020	0.3995	0.4035	0.4011	0.4051	0.4017	0.4067
$\frac{1}{2}$ -13	0.417	0.426	0.421	0.430	0.426	0.434	0.430	0.438	0.4170	0.4225	0.4196	0.4254	0.4226	0.4284	0.4255	0.4313
$\frac{1}{2}$ -12	0.410	0.414	0.414	0.424	0.414	0.428	0.424	0.433	0.4100	0.4161	0.4129	0.4192	0.4160	0.4223	0.4192	0.4255
$\frac{1}{2}$ -20	0.446	0.452	0.449	0.454	0.452	0.457	0.454	0.460	0.4460	0.4498	0.4477	0.4517	0.4497	0.4537	0.4516	0.4556
$\frac{1}{2}$ -28	0.461	0.467	0.463	0.468	0.466	0.470	0.468	0.472	0.4610	0.4645	0.4620	0.4660	0.4636	0.4676	0.4652	0.4692
$\frac{9}{16}$ -12	0.472	0.476	0.476	0.486	0.476	0.490	0.486	0.495	0.4720	0.4783	0.4753	0.4813	0.4783	0.4843	0.4813	0.4873
$\frac{9}{16}$ -18	0.502	0.509	0.505	0.512	0.509	0.515	0.512	0.518	0.5020	0.5065	0.5045	0.5086	0.5065	0.5106	0.5086	0.5127
$\frac{9}{16}$ -24	0.517	0.522	0.520	0.525	0.522	0.527	0.525	0.530	0.5170	0.5209	0.5186	0.5226	0.5204	0.5244	0.5221	0.5261
$\frac{9}{16}$ -28	0.524	0.528	0.526	0.531	0.528	0.532	0.531	0.535	0.5240	0.5270	0.5245	0.5285	0.5261	0.5301	0.5277	0.5317
$\frac{5}{8}$ -11	0.527	0.536	0.532	0.541	0.536	0.546	0.541	0.551	0.5270	0.5328	0.5298	0.5360	0.5329	0.5391	0.5360	0.5422
$\frac{5}{8}$ -12	0.535	0.544	0.540	0.549	0.544	0.553	0.549	0.558	0.5350	0.5406	0.5377	0.5435	0.5405	0.5463	0.5434	0.5492
$\frac{5}{8}$ -18	0.565	0.572	0.568	0.575	0.572	0.578	0.575	0.581	0.5650	0.5690	0.5670	0.5711	0.5690	0.5730	0.5711	0.5752
$\frac{5}{8}$ -24	0.580	0.585	0.583	0.588	0.585	0.590	0.588	0.593	0.5800	0.5834	0.5811	0.5851	0.5829	0.5869	0.5846	0.5886
$\frac{5}{8}$ -28	0.586	0.591	0.588	0.593	0.591	0.595	0.593	0.597	0.5860	0.5895	0.5870	0.5910	0.5886	0.5926	0.5902	0.5942
$\frac{11}{16}$ -12	0.597	0.606	0.602	0.611	0.606	0.615	0.611	0.620	0.5970	0.6029	0.6001	0.6057	0.6029	0.6085	0.6057	0.6113
$\frac{11}{16}$ -24	0.642	0.647	0.645	0.650	0.647	0.652	0.650	0.655	0.6420	0.6459	0.6436	0.6476	0.6454	0.6494	0.6471	0.6511
$\frac{3}{4}$ -10	0.642	0.653	0.647	0.658	0.653	0.663	0.658	0.668	0.6420	0.6481	0.6449	0.6513	0.6481	0.6545	0.6513	0.6577
$\frac{3}{4}$ -12	0.660	0.669	0.665	0.674	0.669	0.678	0.674	0.683	0.6600	0.6652	0.6626	0.6680	0.6653	0.6707	0.6680	0.6734
$\frac{3}{4}$ -16	0.682	0.689	0.686	0.693	0.689	0.696	0.693	0.700	0.6820	0.6866	0.6844	0.6887	0.6865	0.6908	0.6886	0.6929
$\frac{3}{4}$ -20	0.696	0.702	0.699	0.704	0.702	0.707	0.704	0.710	0.6960	0.6996	0.6977	0.7017	0.6997	0.7037	0.7016	0.7056
$\frac{3}{4}$ -28	0.711	0.716	0.713	0.718	0.716	0.720	0.718	0.722	0.7110	0.7145	0.7120	0.7160	0.7136	0.7176	0.7152	0.7192
$\frac{13}{16}$ -12	0.722	0.731	0.727	0.736	0.731	0.740	0.736	0.745	0.7220	0.7276	0.7250	0.7303	0.7276	0.7329	0.7303	0.7356

Table 2. (Continued) Recommended Hole Size Limits Before Tapping Unified Threads

Thread Size	Classes 1B and 2B								Class 3B							
	Length of Engagement ($D =$ Nominal Size of Thread)															
	To and Including $\frac{1}{2}D$		Above $\frac{1}{2}D$ to $\frac{2}{3}D$		Above $\frac{2}{3}D$ to $1\frac{1}{2}D$		Above $1\frac{1}{2}D$ to $3D$		To and Including $\frac{1}{2}D$		Above $\frac{1}{2}D$ to $\frac{2}{3}D$		Above $\frac{2}{3}D$ to $1\frac{1}{2}D$		Above $1\frac{1}{2}D$ to $3D$	
	Recommended Hole Size Limits															
	Min ^a	Max	Min	Max	Min	Max ^b	Min	Max	Min ^a	Max	Min	Max	Min	Max ^b	Min	Max
$\frac{1}{16}$ -16	0.745	0.752	0.749	0.756	0.752	0.759	0.756	0.763	0.7450	0.7491	0.7469	0.7512	0.7490	0.7533	0.7511	0.7554
$\frac{1}{16}$ -20	0.758	0.764	0.761	0.766	0.764	0.770	0.766	0.772	0.7580	0.7623	0.7602	0.7642	0.7622	0.7662	0.7641	0.7681
$\frac{3}{8}$ -9	0.755	0.767	0.761	0.773	0.767	0.778	0.773	0.785	0.7550	0.7614	0.7580	0.7647	0.7614	0.7681	0.7647	0.7714
$\frac{3}{8}$ -12	0.785	0.794	0.790	0.799	0.794	0.803	0.799	0.808	0.7850	0.7926	0.7874	0.7926	0.7900	0.7952	0.7926	0.7978
$\frac{3}{8}$ -14	0.798	0.806	0.802	0.810	0.806	0.814	0.810	0.818	0.7980	0.8022	0.8000	0.8045	0.8023	0.8068	0.8045	0.8090
$\frac{3}{8}$ -16	0.807	0.814	0.811	0.818	0.814	0.821	0.818	0.825	0.8070	0.8116	0.8094	0.8137	0.8115	0.8158	0.8136	0.8179
$\frac{3}{8}$ -20	0.821	0.827	0.824	0.829	0.827	0.832	0.829	0.835	0.8210	0.8248	0.8227	0.8267	0.8247	0.8287	0.8266	0.8306
$\frac{3}{8}$ -28	0.836	0.840	0.838	0.843	0.840	0.845	0.843	0.847	0.8360	0.8395	0.8370	0.8410	0.8386	0.8426	0.8402	0.8442
$\frac{1}{2}$ -12	0.847	0.856	0.852	0.861	0.856	0.865	0.861	0.870	0.8470	0.8524	0.8499	0.8550	0.8524	0.8575	0.8550	0.8601
$\frac{1}{2}$ -16	0.870	0.877	0.874	0.881	0.877	0.884	0.881	0.888	0.8700	0.8741	0.8719	0.8762	0.8740	0.8783	0.8761	0.8804
$\frac{1}{2}$ -20	0.883	0.889	0.886	0.891	0.889	0.895	0.891	0.897	0.8830	0.8873	0.8852	0.8892	0.8872	0.8912	0.8891	0.8931
1-8	0.865	0.878	0.871	0.884	0.878	0.890	0.884	0.896	0.8650	0.8722	0.8684	0.8759	0.8722	0.8797	0.8760	0.8835
1-12	0.910	0.919	0.915	0.924	0.919	0.928	0.924	0.933	0.9100	0.9148	0.9123	0.9173	0.9148	0.9198	0.9173	0.9223
1-14	0.923	0.931	0.927	0.934	0.931	0.938	0.934	0.942	0.9230	0.9271	0.9249	0.9293	0.9271	0.9315	0.9293	0.9337
1-16	0.932	0.939	0.936	0.943	0.939	0.946	0.943	0.950	0.9320	0.9366	0.9344	0.9387	0.9365	0.9408	0.9386	0.9429
1-20	0.946	0.952	0.949	0.954	0.952	0.957	0.954	0.960	0.9460	0.9498	0.9477	0.9517	0.9497	0.9537	0.9516	0.9556
1-28	0.961	0.966	0.963	0.968	0.966	0.970	0.968	0.972	0.9610	0.9645	0.9620	0.9660	0.9636	0.9676	0.9652	0.9692
$1\frac{1}{2}$ -12	0.972	0.981	0.977	0.986	0.981	0.990	0.986	0.995	0.9720	0.9773	0.9748	0.9798	0.9773	0.9823	0.9798	0.9848
$1\frac{1}{2}$ -16	0.995	1.002	0.999	1.005	1.002	1.009	1.005	1.013	0.9950	0.9991	0.9969	1.0012	0.9990	1.0033	1.0011	1.0054
$1\frac{1}{2}$ -18	1.002	1.009	1.005	1.012	1.009	1.015	1.012	1.018	1.0020	1.0065	1.0044	1.0085	1.0064	1.0105	1.0085	1.0126
$1\frac{1}{2}$ -7	0.970	0.984	0.977	0.991	0.984	0.998	0.991	1.005	0.9700	0.9790	0.9747	0.9833	0.9789	0.9875	0.9832	0.9918
$1\frac{1}{2}$ -8	0.990	1.003	0.996	1.009	1.003	1.015	1.009	1.021	0.9900	0.9972	0.9934	1.0009	0.9972	1.0047	1.0010	1.0085
$1\frac{1}{2}$ -12	1.035	1.044	1.040	1.049	1.044	1.053	1.049	1.058	1.0350	1.0398	1.0373	1.0423	1.0398	1.0448	1.0423	1.0473
$1\frac{1}{2}$ -16	1.057	1.064	1.061	1.068	1.064	1.071	1.068	1.075	1.0570	1.0616	1.0594	1.0637	1.0615	1.0658	1.0636	1.0679
$1\frac{1}{2}$ -18	1.065	1.072	1.068	1.075	1.072	1.078	1.075	1.081	1.0650	1.0690	1.0669	1.0710	1.0689	1.0730	1.0710	1.0751
$1\frac{1}{2}$ -20	1.071	1.077	1.074	1.079	1.077	1.082	1.079	1.085	1.0710	1.0748	1.0727	1.0767	1.0747	1.0787	1.0766	1.0806
$1\frac{1}{2}$ -28	1.086	1.091	1.088	1.093	1.091	1.095	1.093	1.097	1.0860	1.0895	1.0870	1.0910	1.0886	1.0926	1.0902	1.0942
$1\frac{1}{2}$ -12	1.097	1.106	1.102	1.111	1.106	1.115	1.111	1.120	1.0970	1.1023	1.0998	1.1048	1.1023	1.1073	1.1048	1.1098

Table 2. (Continued) Recommended Hole Size Limits Before Tapping Unified Threads

Thread Size	Classes 1B and 2B								Class 3B							
	Length of Engagement ($D =$ Nominal Size of Thread)															
	To and Including $\frac{1}{2}D$		Above $\frac{1}{2}D$ to $\frac{2}{3}D$		Above $\frac{2}{3}D$ to $1\frac{1}{2}D$		Above $1\frac{1}{2}D$ to $3D$		To and Including $\frac{1}{2}D$		Above $\frac{1}{2}D$ to $\frac{2}{3}D$		Above $\frac{2}{3}D$ to $1\frac{1}{2}D$		Above $1\frac{1}{2}D$ to $3D$	
	Recommended Hole Size Limits															
	Min ^a	Max	Min	Max	Min	Max ^b	Min	Max	Min ^a	Max	Min	Max	Min	Max ^b	Min	Max
1 $\frac{3}{16}$ -16	1.120	1.127	1.124	1.131	1.127	1.134	1.131	1.138	1.1200	1.1241	1.1219	1.1262	1.1240	1.1283	1.1261	1.1304
1 $\frac{3}{16}$ -18	1.127	1.134	1.130	1.137	1.134	1.140	1.137	1.143	1.1270	1.1315	1.1294	1.1335	1.1314	1.1355	1.1335	1.1376
1 $\frac{1}{2}$ -7	1.095	1.109	1.102	1.116	1.109	1.123	1.116	1.130	1.0950	1.1040	1.0997	1.1083	1.1039	1.1125	1.1082	1.1168
1 $\frac{1}{2}$ -8	1.115	1.128	1.121	1.134	1.128	1.140	1.134	1.146	1.1150	1.1222	1.1184	1.1259	1.1222	1.1297	1.1260	1.1335
1 $\frac{1}{4}$ -12	1.160	1.169	1.165	1.174	1.169	1.178	1.174	1.183	1.1600	1.1648	1.1623	1.1673	1.1648	1.1698	1.1673	1.1723
1 $\frac{1}{4}$ -16	1.182	1.189	1.186	1.193	1.189	1.196	1.193	1.200	1.1820	1.1866	1.1844	1.1887	1.1865	1.1908	1.1886	1.1929
1 $\frac{1}{4}$ -18	1.190	1.197	1.193	1.200	1.197	1.203	1.200	1.206	1.1900	1.1940	1.1919	1.1960	1.1939	1.1980	1.1960	1.2001
1 $\frac{1}{2}$ -20	1.196	1.202	1.199	1.204	1.202	1.207	1.204	1.210	1.1960	1.1998	1.1977	1.2017	1.1997	1.2037	1.2016	1.2056
1 $\frac{3}{16}$ -12	1.222	1.231	1.227	1.236	1.231	1.240	1.236	1.245	1.2220	1.2273	1.2248	1.2298	1.2273	1.2323	1.2298	1.2348
1 $\frac{3}{16}$ -16	1.245	1.252	1.249	1.256	1.252	1.259	1.256	1.263	1.2450	1.2491	1.2469	1.2512	1.2490	1.2533	1.2511	1.2554
1 $\frac{3}{16}$ -18	1.252	1.259	1.256	1.262	1.259	1.265	1.262	1.268	1.2520	1.2565	1.2544	1.2585	1.2564	1.2605	1.2585	1.2626
1 $\frac{3}{8}$ -6	1.195	1.210	1.203	1.221	1.210	1.225	1.221	1.239	1.1950	1.2046	1.1996	1.2096	1.2046	1.2146	1.2096	1.2196
1 $\frac{3}{8}$ -8	1.240	1.253	1.246	1.259	1.253	1.265	1.259	1.271	1.2400	1.2472	1.2434	1.2509	1.2472	1.2547	1.2510	1.2585
1 $\frac{3}{8}$ -12	1.285	1.294	1.290	1.299	1.294	1.303	1.299	1.308	1.2850	1.2898	1.2873	1.2923	1.2898	1.2948	1.2923	1.2973
1 $\frac{3}{8}$ -16	1.307	1.314	1.311	1.318	1.314	1.321	1.318	1.325	1.3070	1.3116	1.3094	1.3137	1.3115	1.3158	1.3136	1.3179
1 $\frac{3}{8}$ -18	1.315	1.322	1.318	1.325	1.322	1.328	1.325	1.331	1.3150	1.3190	1.3169	1.3210	1.3189	1.3230	1.3210	1.3251
1 $\frac{7}{16}$ -12	1.347	1.354	1.350	1.361	1.354	1.365	1.361	1.370	1.3470	1.3523	1.3498	1.3548	1.3523	1.3573	1.3548	1.3598
1 $\frac{7}{16}$ -16	1.370	1.377	1.374	1.381	1.377	1.384	1.381	1.388	1.3700	1.3741	1.3719	1.3762	1.3740	1.3783	1.3761	1.3804
1 $\frac{7}{16}$ -18	1.377	1.384	1.380	1.387	1.384	1.390	1.387	1.393	1.3770	1.3815	1.3794	1.3835	1.3814	1.3855	1.3835	1.3876
1 $\frac{1}{2}$ -6	1.320	1.335	1.328	1.346	1.335	1.350	1.346	1.364	1.3200	1.3296	1.3246	1.3346	1.3296	1.3396	1.3346	1.3446
1 $\frac{1}{2}$ -8	1.365	1.378	1.371	1.384	1.378	1.390	1.384	1.396	1.3650	1.3722	1.3684	1.3759	1.3722	1.3797	1.3760	1.3835
1 $\frac{1}{2}$ -12	1.410	1.419	1.4155	1.424	1.419	1.428	1.424	1.433	1.4100	1.4148	1.4123	1.4173	1.4148	1.4198	1.4173	1.4223
1 $\frac{1}{2}$ -16	1.432	1.439	1.436	1.443	1.439	1.446	1.443	1.450	1.4320	1.4366	1.4344	1.4387	1.4365	1.4408	1.4386	1.4429
1 $\frac{1}{2}$ -18	1.440	1.446	1.443	1.450	1.446	1.452	1.450	1.456	1.4400	1.4440	1.4419	1.4460	1.4439	1.4480	1.4460	1.4501
1 $\frac{1}{2}$ -20	1.446	1.452	1.449	1.454	1.452	1.457	1.454	1.460	1.4460	1.4498	1.4477	1.4517	1.4497	1.4537	1.4516	1.4556
1 $\frac{9}{16}$ -16	1.495	1.502	1.499	1.506	1.502	1.509	1.506	1.513	1.4950	1.4991	1.4969	1.5012	1.4990	1.5033	1.5011	1.5054
1 $\frac{9}{16}$ -18	1.502	1.509	1.505	1.512	1.509	1.515	1.512	1.518	1.5020	1.5065	1.5044	1.5085	1.5064	1.5105	1.5085	1.5126

TAPPING

1929

Table 2. (Continued) Recommended Hole Size Limits Before Tapping Unified Threads

Thread Size	Classes 1B and 2B						Class 3B									
	Length of Engagement ($D =$ Nominal Size of Thread)															
	To and Including $\frac{1}{2}D$		Above $\frac{1}{2}D$ to $\frac{2}{3}D$		Above $\frac{2}{3}D$ to $1\frac{1}{2}D$		Above $1\frac{1}{2}D$ to $3D$		To and Including $\frac{1}{2}D$		Above $\frac{1}{2}D$ to $\frac{2}{3}D$		Above $\frac{2}{3}D$ to $1\frac{1}{2}D$		Above $1\frac{1}{2}D$ to $3D$	
	Recommended Hole Size Limits															
	Min ^a	Max	Min	Max	Min	Max ^b	Min	Max	Min ^a	Max	Min	Max	Min	Max ^b	Min	Max
1 $\frac{1}{8}$ -8	1.490	1.498	1.494	1.509	1.498	1.515	1.509	1.521	1.4900	1.4972	1.4934	1.5009	1.4972	1.5047	1.5010	1.5085
1 $\frac{3}{8}$ -12	1.535	1.544	1.540	1.549	1.544	1.553	1.549	1.558	1.5350	1.5398	1.5373	1.5423	1.5398	1.5448	1.5423	1.5473
1 $\frac{1}{2}$ -16	1.557	1.564	1.561	1.568	1.564	1.571	1.568	1.575	1.5570	1.5616	1.5594	1.5637	1.5615	1.5658	1.5636	1.5679
1 $\frac{3}{4}$ -18	1.565	1.572	1.568	1.575	1.572	1.578	1.575	1.581	1.5650	1.5690	1.5669	1.5710	1.5689	1.5730	1.5710	1.5751
1 $\frac{1}{2}$ -16	1.620	1.627	1.624	1.631	1.627	1.634	1.631	1.638	1.6200	1.6241	1.6219	1.6262	1.6240	1.6283	1.6261	1.6304
1 $\frac{1}{4}$ -18	1.627	1.634	1.630	1.637	1.634	1.640	1.637	1.643	1.6270	1.6315	1.6294	1.6335	1.6314	1.6355	1.6335	1.6376
1 $\frac{3}{8}$ -5	1.534	1.551	1.543	1.560	1.551	1.568	1.560	1.577	1.5340	1.5455	1.5395	1.5515	1.5455	1.5575	1.5515	1.5635
1 $\frac{1}{4}$ -8	1.615	1.628	1.621	1.634	1.628	1.640	1.634	1.646	1.6150	1.6222	1.6184	1.6259	1.6222	1.6297	1.6260	1.6335
1 $\frac{3}{8}$ -12	1.660	1.669	1.665	1.674	1.669	1.678	1.674	1.683	1.6600	1.6648	1.6623	1.6673	1.6648	1.6698	1.6673	1.6723
1 $\frac{1}{2}$ -16	1.682	1.689	1.686	1.693	1.689	1.696	1.693	1.700	1.6820	1.6866	1.6844	1.6887	1.6865	1.6908	1.6886	1.6929
1 $\frac{3}{4}$ -20	1.696	1.702	1.699	1.704	1.702	1.707	1.704	1.710	1.6960	1.6998	1.6977	1.7017	1.6997	1.7037	1.7016	1.7056
1 $\frac{1}{2}$ -16	1.745	1.752	1.749	1.756	1.752	1.759	1.756	1.763	1.7450	1.7491	1.7469	1.7512	1.7490	1.7533	1.7511	1.7554
1 $\frac{3}{8}$ -8	1.740	1.752	1.746	1.759	1.752	1.765	1.759	1.771	1.7400	1.7472	1.7434	1.7509	1.7472	1.7547	1.7510	1.7585
1 $\frac{1}{2}$ -12	1.785	1.794	1.790	1.799	1.794	1.803	1.799	1.808	1.7850	1.7898	1.7873	1.7923	1.7898	1.7948	1.7923	1.7973
1 $\frac{3}{4}$ -16	1.807	1.814	1.810	1.818	1.814	1.821	1.818	1.825	1.8070	1.8116	1.8094	1.8137	1.8115	1.8158	1.8136	1.8179
1 $\frac{1}{2}$ -16	1.870	1.877	1.874	1.881	1.877	1.884	1.881	1.888	1.8700	1.8741	1.8719	1.8762	1.8740	1.8783	1.8761	1.8804
2-4 $\frac{1}{2}$	1.759	1.777	1.768	1.786	1.777	1.795	1.786	1.804	1.7590	1.7727	1.7661	1.7794	1.7728	1.7861	1.7794	1.7927
2-8	1.865	1.878	1.871	1.884	1.878	1.890	1.884	1.896	1.8650	1.8722	1.8684	1.8759	1.8722	1.8797	1.8760	1.8835
2-12	1.910	1.919	1.915	1.924	1.919	1.928	1.924	1.933	1.9100	1.9148	1.9123	1.9173	1.9148	1.9198	1.9173	1.9223
2-16	1.932	1.939	1.936	1.943	1.939	1.946	1.943	1.950	1.9320	1.9366	1.9344	1.9387	1.9365	1.9408	1.9386	1.9429
2-20	1.946	1.952	1.949	1.954	1.952	1.957	1.954	1.960	1.9460	1.9498	1.9477	1.9517	1.9497	1.9537	1.9516	1.9556
2 $\frac{1}{16}$ -16	1.995	2.002	2.000	2.006	2.002	2.009	2.006	2.012	1.9950	1.9991	1.9969	2.0012	1.9990	2.0033	2.0011	2.0054
2 $\frac{1}{8}$ -8	1.990	2.003	1.996	2.009	2.003	2.015	2.009	2.021	1.9900	1.9972	1.9934	2.0009	1.9972	2.0047	2.0010	2.0085
2 $\frac{1}{8}$ -12	2.035	2.044	2.040	2.049	2.044	2.053	2.049	2.058	2.0350	2.0398	2.0373	2.0423	2.0398	2.0448	2.0423	2.0473
2 $\frac{1}{4}$ -16	2.057	2.064	2.061	2.068	2.064	2.071	2.068	2.075	2.0570	2.0616	2.0594	2.0637	2.0615	2.0658	2.0636	2.0679
2 $\frac{1}{16}$ -16	2.120	2.127	2.124	2.131	2.127	2.134	2.131	2.138	2.1200	2.1241	2.1219	2.1262	2.1240	2.1283	2.1261	2.1304
2 $\frac{1}{4}$ -4 $\frac{1}{2}$	2.009	2.027	2.018	2.036	2.027	2.045	2.036	2.054	2.0090	2.0227	2.0161	2.0294	2.0228	2.0361	2.0294	2.0427

Table 2. (Continued) Recommended Hole Size Limits Before Tapping Unified Threads

Thread Size	Classes 1B and 2B						Class 3B									
	Length of Engagement ($D =$ Nominal Size of Thread)															
	To and Including $\frac{1}{2}D$		Above $\frac{1}{2}D$ to $\frac{2}{3}D$		Above $\frac{2}{3}D$ to $1\frac{1}{2}D$		Above $1\frac{1}{2}D$ to $3D$		To and Including $\frac{1}{2}D$		Above $\frac{1}{2}D$ to $1\frac{1}{2}D$		Above $1\frac{1}{2}D$ to $3D$			
	Recommended Hole Size Limits															
	Min ^a	Max	Min	Max	Min	Max ^b	Min	Max	Min ^a	Max	Min	Max	Min	Max ^b	Min	Max
$2\frac{1}{4}$ -8	2.115	2.128	2.121	2.134	2.128	2.140	2.134	2.146	2.1150	2.1222	2.1184	2.1259	2.1222	2.1297	2.1260	2.1335
$2\frac{1}{4}$ -12	2.160	2.169	2.165	2.174	2.169	2.178	2.174	2.182	2.1600	2.1648	2.1623	2.1673	2.1648	2.1698	2.1673	2.1723
$2\frac{1}{4}$ -16	2.182	2.189	2.186	2.193	2.189	2.196	2.193	2.200	2.1820	2.1866	2.1844	2.1887	2.1865	2.1908	2.1886	2.1929
$2\frac{1}{4}$ -20	2.196	2.202	2.199	2.204	2.202	2.207	2.204	2.210	2.1960	2.1998	2.1977	2.2017	2.1997	2.2037	2.2016	2.2056
$2\frac{3}{16}$ -16	2.245	2.252	2.249	2.256	2.252	2.259	2.256	2.263	2.2450	2.2491	2.2469	2.2512	2.2490	2.2533	2.2511	2.2554
$2\frac{3}{8}$ -12	2.285	2.294	2.290	2.299	2.294	2.303	2.299	2.308	2.2850	2.2898	2.2873	2.2923	2.2898	2.2948	2.2923	2.2973
$2\frac{3}{8}$ -16	2.307	2.314	2.311	2.318	2.314	2.321	2.318	2.325	2.3070	2.3116	2.3094	2.3137	2.3115	2.3158	2.3136	2.3179
$2\frac{3}{8}$ -20	2.370	2.377	2.374	2.381	2.377	2.384	2.381	2.388	2.3700	2.3741	2.3719	2.3762	2.3740	2.3783	2.3761	2.3804
$2\frac{1}{2}$ -4	2.229	2.248	2.238	2.258	2.248	2.267	2.258	2.277	2.2290	2.2444	2.2369	2.2519	2.2444	2.2594	2.2519	2.2669
$2\frac{1}{2}$ -8	2.365	2.378	2.371	2.384	2.378	2.390	2.384	2.396	2.3650	2.3722	2.3684	2.3759	2.3722	2.3797	2.3760	2.3835
$2\frac{1}{2}$ -12	2.410	2.419	2.415	2.424	2.419	2.428	2.424	2.433	2.4100	2.4148	2.4123	2.4173	2.4148	2.4198	2.4173	2.4223
$2\frac{1}{2}$ -16	2.432	2.439	2.436	2.443	2.439	2.446	2.443	2.450	2.4320	2.4366	2.4344	2.4387	2.4365	2.4408	2.4386	2.4429
$2\frac{1}{2}$ -20	2.446	2.452	2.449	2.454	2.452	2.457	2.454	2.460	2.4460	2.4498	2.4478	2.4517	2.4497	2.4537	2.4516	2.4556
$2\frac{3}{8}$ -12	2.535	2.544	2.540	2.549	2.544	2.553	2.549	2.558	2.5350	2.5398	2.5373	2.5423	2.5398	2.5448	2.5423	2.5473
$2\frac{3}{8}$ -16	2.557	2.564	2.561	2.568	2.564	2.571	2.568	2.575	2.5570	2.5616	2.5594	2.5637	2.5615	2.5658	2.5636	2.5679
$2\frac{3}{8}$ -20	2.479	2.498	2.489	2.508	2.498	2.517	2.508	2.527	2.4790	2.4944	2.4869	2.5019	2.4944	2.5094	2.5019	2.5169
$2\frac{3}{4}$ -8	2.615	2.628	2.621	2.634	2.628	2.640	2.634	2.644	2.6150	2.6222	2.6184	2.6259	2.6222	2.6297	2.6260	2.6335
$2\frac{3}{4}$ -12	2.660	2.669	2.665	2.674	2.669	2.678	2.674	2.683	2.6600	2.6648	2.6623	2.6673	2.6648	2.6698	2.6673	2.6723
$2\frac{3}{4}$ -16	2.682	2.689	2.686	2.693	2.689	2.696	2.693	2.700	2.6820	2.6866	2.6844	2.6887	2.6865	2.6908	2.6886	2.6929
$2\frac{3}{4}$ -20	2.785	2.794	2.790	2.809	2.794	2.803	2.809	2.808	2.7850	2.7898	2.7873	2.7923	2.7898	2.7948	2.7923	2.7973
$2\frac{1}{2}$ -16	2.807	2.814	2.811	2.818	2.814	2.821	2.818	2.825	2.8070	2.8116	2.8094	2.8137	2.8115	2.8158	2.8136	2.8179
3-4	2.729	2.748	2.739	2.758	2.748	2.767	2.758	2.777	2.7290	2.7444	2.7369	2.7519	2.7444	2.7594	2.7519	2.7669
3-8	2.865	2.878	2.871	2.884	2.878	2.890	2.884	2.896	2.8650	2.8722	2.8684	2.8759	2.8722	2.8797	2.8760	2.8835
3-12	2.910	2.919	2.915	2.924	2.919	2.928	2.924	2.933	2.9100	2.9148	2.9123	2.9173	2.9148	2.9198	2.9173	2.9223
3-16	2.932	2.939	2.936	2.943	2.939	2.946	2.943	2.950	2.9320	2.9366	2.9344	2.9387	2.9365	2.9408	2.9386	2.9429
$3\frac{1}{8}$ -12	3.035	3.044	3.040	3.049	3.044	3.053	3.049	3.058	3.0350	3.0398	3.0373	3.0423	3.0398	3.0448	3.0423	3.0473
$3\frac{1}{8}$ -16	3.057	3.064	3.061	3.068	3.064	3.071	3.068	3.075	3.0570	3.0616	3.0594	3.0637	3.0615	3.0658	3.0636	3.0679

Table 2. (Continued) Recommended Hole Size Limits Before Tapping Unified Threads

Thread Size	Classes 1B and 2B								Class 3B							
	Length of Engagement ($D =$ Nominal Size of Thread)															
	To and Including $\frac{1}{3}D$		Above $\frac{1}{3}D$ to $\frac{2}{3}D$		Above $\frac{2}{3}D$ to $1\frac{1}{2}D$		Above $1\frac{1}{2}D$ to $3D$		To and Including $\frac{1}{3}D$		Above $\frac{1}{3}D$ to $\frac{2}{3}D$		Above $\frac{2}{3}D$ to $1\frac{1}{2}D$		Above $1\frac{1}{2}D$ to $3D$	
	Recommended Hole Size Limits															
	Min ^a	Max	Min	Max	Min	Max ^b	Min	Max	Min ^a	Max	Min	Max	Min	Max ^b	Min	Max
$3\frac{1}{8}$ -4	2.979	2.998	2.989	3.008	2.998	3.017	3.008	3.027	2.9790	2.9944	2.9869	3.0019	2.9944	3.0094	3.0019	3.0169
$3\frac{1}{8}$ -8	3.115	3.128	3.121	3.134	3.128	3.140	3.134	3.146	3.1150	3.1222	3.1184	3.1259	3.1222	3.1297	3.1260	3.1335
$3\frac{1}{8}$ -12	3.160	3.169	3.165	3.174	3.169	3.178	3.174	3.183	3.1600	3.1648	3.1623	3.1673	3.1648	3.1698	3.1673	3.1723
$3\frac{1}{8}$ -16	3.182	3.189	3.186	3.193	3.189	3.196	3.193	3.200	3.1820	3.1866	3.1844	3.1887	3.1865	3.1908	3.1886	3.1929
$3\frac{3}{8}$ -4	3.285	3.294	3.290	3.299	3.294	3.303	3.299	3.299	3.2850	3.2898	3.2873	3.2923	3.2898	3.2948	3.2923	3.2973
$3\frac{3}{8}$ -8	3.307	3.314	3.311	3.318	3.314	3.321	3.317	3.325	3.3070	3.3116	3.3094	3.3137	3.3115	3.3158	3.3136	3.3179
$3\frac{3}{8}$ -12	3.229	3.248	3.239	3.258	3.248	3.267	3.258	3.277	3.2290	3.2444	3.2369	3.2519	3.2444	3.2594	3.2519	3.2669
$3\frac{3}{8}$ -16	3.365	3.378	3.371	3.384	3.378	3.390	3.384	3.396	3.3650	3.3722	3.3684	3.3759	3.3722	3.3797	3.3760	3.3835
$3\frac{1}{2}$ -4	3.410	3.419	3.415	3.424	3.419	3.428	3.424	3.433	3.4100	3.4148	3.4123	3.4173	3.4148	3.4198	3.4173	3.4223
$3\frac{1}{2}$ -8	3.432	3.439	3.436	3.443	3.439	3.446	3.443	3.450	3.4320	3.4366	3.4344	3.4387	3.4365	3.4408	3.4386	3.4429
$3\frac{1}{2}$ -12	3.535	3.544	3.544	3.549	3.544	3.553	3.549	3.553	3.5350	3.5398	3.5373	3.5423	3.5398	3.5448	3.5423	3.5473
$3\frac{1}{2}$ -16	3.557	3.564	3.561	3.568	3.567	3.571	3.568	3.575	3.5570	3.5616	3.5594	3.5637	3.5615	3.5658	3.5636	3.5679
$3\frac{7}{8}$ -4	3.479	3.498	3.489	3.508	3.498	3.517	3.508	3.527	3.4790	3.4944	3.4869	3.5019	3.4944	3.5094	3.5019	3.5169
$3\frac{7}{8}$ -8	3.615	3.628	3.615	3.634	3.628	3.640	3.634	3.646	3.6150	3.6222	3.6184	3.6259	3.6222	3.6297	3.6260	3.6335
$3\frac{7}{8}$ -12	3.660	3.669	3.665	3.674	3.669	3.678	3.674	3.683	3.6600	3.6648	3.6623	3.6673	3.6648	3.6698	3.6673	3.6723
$3\frac{7}{8}$ -16	3.682	3.689	3.686	3.693	3.689	3.696	3.693	3.700	3.6820	3.6866	3.6844	3.6887	3.6865	3.6908	3.6886	3.6929
4 -4	3.785	3.794	3.790	3.799	3.794	3.803	3.799	3.808	3.7850	3.7898	3.7873	3.7923	3.7898	3.7948	3.7923	3.7973
4 -8	3.807	3.814	3.811	3.818	3.814	3.821	3.818	3.825	3.8070	3.8116	3.8094	3.8137	3.8115	3.8158	3.8136	3.8179
4 -12	3.729	3.748	3.739	3.758	3.748	3.767	3.758	3.777	3.7290	3.7444	3.7369	3.7519	3.7444	3.7594	3.7519	3.7669
4 -16	3.865	3.878	3.871	3.884	3.878	3.890	3.884	3.896	3.8650	3.8722	3.8684	3.8759	3.8722	3.8797	3.8760	3.8835
$4\frac{1}{2}$ -4	3.910	3.919	3.915	3.924	3.919	3.928	3.924	3.933	3.9100	3.9148	3.9123	3.9173	3.9148	3.9198	3.9173	3.9223
$4\frac{1}{2}$ -8	3.932	3.939	3.936	3.943	3.939	3.946	3.943	3.950	3.9320	3.9366	3.9344	3.9387	3.9365	3.9408	3.9386	3.9429
$4\frac{1}{2}$ -12	3.979	3.998	3.989	4.008	3.998	4.017	4.008	4.027	3.9790	3.9944	3.9869	4.0019	3.9944	4.0094	4.0019	4.0169
$4\frac{1}{2}$ -16	4.115	4.128	4.121	4.134	4.128	4.140	4.134	4.146	4.1150	4.1222	4.1184	4.1259	4.1222	4.1297	4.1260	4.1335
$4\frac{3}{4}$ -4	4.160	4.169	4.165	4.174	4.169	4.178	4.174	4.183	4.1600	4.1648	4.1623	4.1673	4.1648	4.1698	4.1673	4.1723
$4\frac{3}{4}$ -8	4.182	4.189	4.186	4.193	4.189	4.196	4.193	4.200	4.1820	4.1866	4.1844	4.1887	4.1865	4.1908	4.1886	4.1929
$4\frac{3}{4}$ -12	4.229	4.248	4.239	4.258	4.248	4.267	4.258	4.277	4.2290	4.2444	4.2369	4.2519	4.2444	4.2594	4.2519	4.2669

Table 2. (Continued) Recommended Hole Size Limits Before Tapping Unified Threads

Thread Size	Classes 1B and 2B								Class 3B							
	Length of Engagement ($D =$ Nominal Size of Thread)															
	To and Including $\frac{1}{2}D$		Above $\frac{1}{2}D$ to $\frac{2}{3}D$		Above $\frac{2}{3}D$ to $1\frac{1}{2}D$		Above $1\frac{1}{2}D$ to $3D$		To and Including $\frac{1}{2}D$		Above $\frac{1}{2}D$ to $\frac{2}{3}D$		Above $\frac{2}{3}D$ to $1\frac{1}{2}D$		Above $1\frac{1}{2}D$ to $3D$	
	Recommended Hole Size Limits															
	Min ^a	Max	Min	Max	Min	Max ^b	Min	Max	Min ^a	Max	Min	Max	Min	Max ^b	Min	Max
4 $\frac{1}{2}$ -8	4.365	4.378	4.371	4.384	4.378	4.390	4.384	4.396	4.3650	4.3722	4.3684	4.3759	4.3722	4.3797	4.3760	4.3835
4 $\frac{1}{2}$ -12	4.410	4.419	4.419	4.424	4.419	4.428	4.424	4.433	4.4100	4.4148	4.4123	4.4173	4.4148	4.4198	4.4173	4.4223
4 $\frac{1}{2}$ -16	4.432	4.439	4.437	4.444	4.439	4.446	4.444	4.455	4.4320	4.4366	4.4344	4.4387	4.4365	4.4408	4.4386	4.4429
4 $\frac{3}{4}$ -8	4.615	4.628	4.621	4.646	4.628	4.640	4.646	4.646	4.6150	4.6222	4.6184	4.6259	4.6222	4.6297	4.6260	4.6335
4 $\frac{3}{4}$ -12	4.660	4.669	4.665	4.674	4.669	4.678	4.674	4.683	4.6600	4.6648	4.6623	4.6673	4.6648	4.6698	4.6673	4.6723
4 $\frac{3}{4}$ -16	4.682	4.689	4.686	4.693	4.689	4.696	4.693	4.700	4.6820	4.6866	4.6844	4.6887	4.6865	4.6908	4.6886	4.6929
5-8	4.865	4.878	4.871	4.884	4.878	4.890	4.884	4.896	4.8650	4.8722	4.8684	4.8759	4.8722	4.8797	4.8760	4.8835
5-12	4.910	4.919	4.915	4.924	4.919	4.928	4.924	4.933	4.9100	4.9148	4.9123	4.9173	4.9148	4.9198	4.9173	4.9223
5-16	4.932	4.939	4.936	4.943	4.939	4.946	4.943	4.950	4.9320	4.9366	4.9344	4.9387	4.9365	4.9408	4.9386	4.9429
5 $\frac{1}{2}$ -8	5.115	5.128	5.121	5.134	5.128	5.140	5.134	5.146	5.1150	5.1222	5.1184	5.1259	5.1222	5.1297	5.1260	5.1335
5 $\frac{1}{2}$ -12	5.160	5.169	5.165	5.174	5.169	5.178	5.174	5.183	5.1600	5.1648	5.1623	5.1673	5.1648	5.1698	5.1673	5.1723
5 $\frac{1}{2}$ -16	5.182	5.189	5.186	5.193	5.189	5.196	5.193	5.200	5.1820	5.1866	5.1844	5.1887	5.1865	5.1908	5.1886	5.1929
5 $\frac{1}{2}$ -8	5.365	5.378	5.371	5.384	5.378	5.390	5.384	5.396	5.3650	5.3722	5.3684	5.3759	5.3722	5.3797	5.3760	5.3835
5 $\frac{1}{2}$ -12	5.410	5.419	5.415	5.424	5.419	5.428	5.424	5.433	5.4100	5.4148	5.4123	5.4173	5.4148	5.4198	5.4173	5.4223
5 $\frac{1}{2}$ -16	5.432	5.439	5.436	5.442	5.439	5.446	5.442	5.450	5.4320	5.4366	5.4344	5.4387	5.4365	5.4408	5.4386	5.4429
5 $\frac{3}{4}$ -8	5.615	5.628	5.621	5.634	5.628	5.640	5.634	5.646	5.6150	5.6222	5.6184	5.6259	5.6222	5.6297	5.6260	5.6335
5 $\frac{3}{4}$ -12	5.660	5.669	5.665	5.674	5.669	5.678	5.674	5.683	5.6600	5.6648	5.6623	5.6673	5.6648	5.6698	5.6673	5.6723
5 $\frac{3}{4}$ -16	5.682	5.689	5.686	5.693	5.689	5.696	5.693	5.700	5.6820	5.6866	5.6844	5.6887	5.6865	5.6908	5.6886	5.6929
6-8	5.865	5.878	5.871	5.896	5.878	5.890	5.896	5.896	5.8650	5.8722	5.8684	5.8759	5.8722	5.8797	5.8760	5.8835
6-12	5.910	5.919	5.915	5.924	5.919	5.928	5.924	5.933	5.9100	5.9148	5.9123	5.9173	5.9148	5.9198	5.9173	5.9223
6-16	5.932	5.939	5.935	5.943	5.939	5.946	5.943	5.950	5.9320	5.9366	5.9344	5.9387	5.9365	5.9408	5.9386	5.9429

^a This is the minimum minor diameter specified in the thread tables, page 1723.

^b This is the maximum minor diameter specified in the thread tables, page 1723.

All dimensions are in inches.

For basis of recommended hole size limits see accompanying text.

As an aid in selecting suitable drills, see the listing of American Standard drill sizes in the twist drill section. For amount of expected drill oversize, see page 873.

Table 3. Tap Drill Sizes for Threads of American National Form

Screw Thread		Commercial Tap Drills ^a		Screw Thread		Commercial Tap Drills ^a	
Outside Diam. Pitch	Root Diam.	Size or Number	Decimal Equiv.	Outside Diam. Pitch	Root Diam.	Size or Number	Decimal Equiv.
$\frac{1}{16}$ -64	0.0422	$\frac{3}{64}$	0.0469	27	0.4519	$\frac{15}{32}$	0.4687
72	0.0445	$\frac{3}{64}$	0.0469	$\frac{9}{16}$ -12	0.4542	$\frac{3}{64}$	0.4844
$\frac{5}{64}$ -60	0.0563	$\frac{1}{16}$	0.0625	18	0.4903	$\frac{3}{64}$	0.5156
72	0.0601	52	0.0635	27	0.5144	$\frac{17}{32}$	0.5312
$\frac{3}{32}$ -48	0.0667	49	0.0730	$\frac{5}{8}$ -11	0.5069	$\frac{17}{32}$	0.5312
50	0.0678	49	0.0730	12	0.5168	$\frac{3}{64}$	0.5469
$\frac{7}{64}$ -48	0.0823	43	0.0890	18	0.5528	$\frac{3}{64}$	0.5781
$\frac{1}{8}$ -32	0.0844	$\frac{3}{32}$	0.0937	27	0.5769	$\frac{19}{32}$	0.5937
40	0.0925	38	0.1015	$\frac{11}{16}$ -11	0.5694	$\frac{19}{32}$	0.5937
$\frac{9}{64}$ -40	0.1081	32	0.1160	16	0.6063	$\frac{3}{64}$	0.6250
$\frac{5}{32}$ -32	0.1157	$\frac{1}{8}$	0.1250	$\frac{3}{4}$ -10	0.6201	$\frac{21}{32}$	0.6562
36	0.1202	30	0.1285	12	0.6418	$\frac{4}{64}$	0.6719
$\frac{11}{64}$ -32	0.1313	$\frac{9}{64}$	0.1406	16	0.6688	$\frac{11}{16}$	0.6875
$\frac{3}{16}$ -24	0.1334	26	0.1470	27	0.7019	$\frac{23}{32}$	0.7187
32	0.1469	22	0.1570	$\frac{13}{16}$ -10	0.6826	$\frac{23}{32}$	0.7187
$\frac{13}{64}$ -24	0.1490	20	0.1610	$\frac{7}{8}$ -9	0.7307	$\frac{49}{64}$	0.7656
$\frac{7}{32}$ -24	0.1646	16	0.1770	12	0.7668	$\frac{3}{64}$	0.7969
32	0.1782	12	0.1890	14	0.7822	$\frac{17}{16}$	0.8125
$\frac{15}{64}$ -24	0.1806	10	0.1935	18	0.8028	$\frac{53}{64}$	0.8281
$\frac{1}{4}$ -20	0.1850	7	0.2010	27	0.8269	$\frac{27}{32}$	0.8437
24	0.1959	4	0.2090	$\frac{15}{16}$ -9	0.7932	$\frac{53}{64}$	0.8281
27	0.2019	3	0.2130	1-8	0.8376	$\frac{7}{8}$	0.8750
28	0.2036	3	0.2130	12	0.8918	$\frac{39}{64}$	0.9219
32	0.2094	$\frac{7}{32}$	0.2187	14	0.9072	$\frac{15}{16}$	0.9375
$\frac{5}{16}$ -18	0.2403	F	0.2570	27	0.9519	$\frac{31}{32}$	0.9687
20	0.2476	$\frac{17}{64}$	0.2656	$\frac{1}{8}$ -7	0.9394	$\frac{63}{64}$	0.9844
24	0.2584	I	0.2720	12	1.0168	$\frac{13}{64}$	1.0469
27	0.2644	J	0.2770	$\frac{1}{4}$ -7	1.0644	$\frac{17}{64}$	1.1094
32	0.2719	$\frac{9}{32}$	0.2812	12	1.1418	$\frac{11}{16}$	1.1719
$\frac{3}{8}$ -16	0.2938	$\frac{5}{16}$	0.3125	$\frac{1}{8}$ -6	1.1585	$\frac{17}{32}$	1.2187
20	0.3100	$\frac{21}{64}$	0.3281	12	1.2668	$\frac{19}{64}$	1.2969
24	0.3209	Q	0.3320	$\frac{1}{2}$ -6	1.2835	$\frac{11}{16}$	1.3437
27	0.3269	R	0.3390	12	1.3918	$\frac{17}{64}$	1.4219
$\frac{7}{16}$ -14	0.3447	U	0.3680	$\frac{1}{8}$ -5 $\frac{1}{2}$	1.3888	$\frac{13}{64}$	1.4531
20	0.3726	$\frac{25}{64}$	0.3906	$\frac{1}{4}$ -5	1.4902	$\frac{19}{64}$	1.5625
24	0.3834	X	0.3970	$\frac{1}{8}$ -5	1.6152	$\frac{11}{16}$	1.6875
27	0.3894	Y	0.4040	2-4 $\frac{1}{2}$	1.7113	$\frac{15}{32}$	1.7812
$\frac{1}{2}$ -12	0.3918	$\frac{27}{64}$	0.4219	$\frac{21}{8}$ -4 $\frac{1}{2}$	1.8363	$\frac{13}{32}$	1.9062
13	0.4001	$\frac{27}{64}$	0.4219	$\frac{21}{8}$ -4 $\frac{1}{2}$	1.9613	$\frac{21}{32}$	2.0312
20	0.4351	$\frac{29}{64}$	0.4531	$\frac{23}{8}$ -4	2.0502	$\frac{21}{8}$	2.1250
24	0.4459	$\frac{29}{64}$	0.4531	$\frac{23}{2}$ -4	2.1752	$\frac{21}{4}$	2.2500

^aThese tap drill diameters allow approximately 75 per cent of a full thread to be produced. For small thread sizes in the first column, the use of drills to produce the larger hole sizes shown in Table 2 will reduce defects caused by tap problems and breakage.

Table 4. Tap Drills and Clearance Drills for Machine Screws with American National Thread Form

Size of Screw		No. of Threads per Inch	Tap Drills		Clearance Hole Drills			
No. or Diam.	Decimal Equiv.		Drill Size	Decimal Equiv.	Close Fit		Free Fit	
					Drill Size	Decimal Equiv.	Drill Size	Decimal Equiv.
0	.060	80	$\frac{3}{64}$.0469	52	.0635	50	.0700
1	.073	64	53	.0595	48	.0760	46	.0810
		72	53	.0595				
2	.086	56	50	.0700	43	.0890	41	.0960
		64	50	.0700				
3	.099	48	47	.0785	37	.1040	35	.1100
		56	45	.0820				
4	.112	36 ^a	44	.0860	32	.1160	30	.1285
		40	43	.0890				
		48	42	.0935				
5	.125	40	38	.1015	30	.1285	29	.1360
		44	37	.1040				
6	.138	32	36	.1065	27	.1440	25	.1495
		40	33	.1130				
8	.164	32	29	.1360	18	.1695	16	.1770
		36	29	.1360				
10	.190	24	25	.1495	9	.1960	7	.2010
		32	21	.1590				
12	.216	24	16	.1770	2	.2210	1	.2280
		28	14	.1820				
14	.242	20 ^a	10	.1935	D	.2460	F	.2570
		24 ^a	7	.2010				
$\frac{1}{4}$.250	20	7	.2010	F	.2570	H	.2660
		28	3	.2130				
$\frac{5}{16}$.3125	18	F	.2570	P	.3230	Q	.3320
		24	I	.2720				
$\frac{3}{8}$.375	16	$\frac{5}{16}$.3125	W	.3860	X	.3970
		24	Q	.3320				
$\frac{7}{16}$.4375	14	U	.3680	$\frac{29}{64}$.4531	$\frac{15}{32}$.4687
		20	$\frac{25}{64}$.3906				
$\frac{1}{2}$.500	13	$\frac{27}{64}$.4219	$\frac{33}{64}$.5156	$\frac{17}{32}$.5312
		20	$\frac{29}{64}$.4531				

^aThese screws are not in the American Standard but are from the former A.S.M.E. Standard.

The size of the tap drill hole for any desired percentage of full thread depth can be calculated by the formulas below. In these formulas the Per Cent Full Thread is expressed as a decimal; e.g., 75 per cent is expressed as .75. The tap drill size is the size nearest to the calculated hole size.

For American Unified Thread form:

$$\text{Hole Size} = \text{Basic Major Diameter} - \frac{1.08253 \times \text{Per Cent Full Thread}}{\text{Number of Threads per Inch}}$$

For ISO Metric threads (all dimensions in millimeters):

$$\text{Hole Size} = \text{Basic Major Diameter} - (1.08253 \times \text{Pitch} \times \text{Per Cent Full Thread})$$

The constant 1.08253 in the above equation represents $5H/8$ where H is the height of a sharp V-thread (see page 1712). (The pitch is taken to be 1.)

Factors Influencing Minor Diameter Tolerances of Tapped Holes.—As stated in the Unified screw thread standard, the principle practical factors that govern minor diameter tolerances of internal threads are tapping difficulties, particularly tap breakage in the small sizes, availability of standard drill sizes in the medium and large sizes, and depth (radial) of engagement. Depth of engagement is related to the stripping strength of the thread assembly, and thus also, to the length of engagement. It also has an influence on the tendency toward disengagement of the threads on one side when assembly is eccentric. The amount of possible eccentricity is one-half of the sum of the pitch diameter allowance and toler-

ances on both mating threads. For a given pitch, or height of thread, this sum increases with the diameter, and accordingly this factor would require a decrease in minor diameter tolerance with increase in diameter. However, such decrease in tolerance would often require the use of special drill sizes; therefore, to facilitate the use of standard drill sizes, for any given pitch the minor diameter tolerance for Unified thread classes 1B and 2B threads of $\frac{1}{4}$ inch diameter and larger is constant, in accordance with a formula given in the American Standard for Unified Screw Threads.

Effect of Length of Engagement of Minor Diameter Tolerances: There may be applications where the lengths of engagement of mating threads is relatively short or the combination of materials used for mating threads is such that the maximum minor diameter tolerance given in the Standard (based on a length of engagement equal to the nominal diameter) may not provide the desired strength of the fastening. Experience has shown that for lengths of engagement less than $\frac{2}{3}D$ (the minimum thickness of standard nuts) the minor diameter tolerance may be reduced without causing tapping difficulties. In other applications the length of engagement of mating threads may be long because of design considerations or the combination of materials used for mating threads. As the threads engaged increase in number, a shallower depth of engagement may be permitted and still develop stripping strength greater than the external thread breaking strength. Under these conditions the maximum tolerance given in the Standard should be increased to reduce the possibility of tapping difficulties. The following paragraphs indicate how the aforementioned considerations were taken into account in determining the minor diameter limits for various lengths of engagement given in [Table 2](#).

Recommended Hole Sizes before Tapping.—Recommended hole size limits before threading to provide for optimum strength of fastenings and tapping conditions are shown in [Table 2](#) for classes 1B, 2B, and 3B. The hole size limit before threading, and the tolerances between them, are derived from the minimum and maximum minor diameters of the internal thread given in the dimensional tables for Unified threads in the screw thread section using the following rules:

- 1) For lengths of engagement in the range to and including $\frac{1}{3}D$, where D equals nominal diameter, the minimum hole size will be equal to the minimum minor diameter of the internal thread and the maximum hole size will be larger by one-half the minor diameter tolerance.
- 2) For the range from $\frac{1}{3}D$ to $\frac{2}{3}D$, the minimum and maximum hole sizes will each be one quarter of the minor diameter tolerance larger than the corresponding limits for the length of engagement to and including $\frac{1}{3}D$.
- 3) For the range from $\frac{2}{3}D$ to $1\frac{1}{2}D$ the minimum hole size will be larger than the minimum minor diameter of the internal thread by one-half the minor diameter tolerance and the maximum hole size will be equal to the maximum minor diameter.
- 4) For the range from $1\frac{1}{2}D$ to $3D$ the minimum and maximum hole sizes will each be one-quarter of the minor diameter tolerance of the internal thread larger than the corresponding limits for the $\frac{2}{3}D$ to $1\frac{1}{2}D$ length of engagement.

From the foregoing it will be seen that the difference between limits in each range is the same and equal to one-half of the minor diameter tolerance given in the Unified screw thread dimensional tables. This is a general rule, except that the minimum differences for sizes below $\frac{1}{4}$ inch are equal to the minor diameter tolerances calculated on the basis of lengths of engagement to and including $\frac{1}{3}D$. Also, for lengths of engagement greater than $\frac{1}{3}D$ and for sizes $\frac{1}{4}$ inch and larger the values are adjusted so that the difference between limits is never less than 0.004 inch.

For diameter-pitch combinations other than those given in [Table 2](#), the foregoing rules should be applied to the tolerances given in the dimensional tables in the screw thread sec-

tion or the tolerances derived from the formulas given in the Standard to determine the hole size limits.

Selection of Tap Drills: In selecting standard drills to produce holes within the limits given in Table 2 it should be recognized that drills have a tendency to cut oversize. The material on page 873 may be used as a guide to the expected amount of oversize.

Table 5. Unified Miniature Screw Threads—Recommended Hole Size Limits Before Tapping

Thread Size		Internal Threads		Lengths of Engagement					
Designation	Pitch	Minor Diameter Limits		To and including $\frac{2}{3}D$		Above $\frac{2}{3}D$ to $1\frac{1}{2}D$		Above $1\frac{1}{2}D$ to $3D$	
		Min	Max	Min	Max	Recommended Hole Size Limits			
						Min	Max	Min	Max
mm	mm	mm	mm	mm	mm	mm	mm	mm	mm
0.30 UNM	0.080	0.217	0.254	0.226	0.240	0.236	0.254	0.245	0.264
0.35 UNM	0.090	0.256	0.297	0.267	0.282	0.277	0.297	0.287	0.307
0.40 UNM	0.100	0.296	0.340	0.307	0.324	0.318	0.340	0.329	0.351
0.45 UNM	0.100	0.346	0.390	0.357	0.374	0.368	0.390	0.379	0.401
0.50 UNM	0.125	0.370	0.422	0.383	0.402	0.396	0.422	0.409	0.435
0.55 UNM	0.125	0.420	0.472	0.433	0.452	0.446	0.472	0.459	0.485
0.60 UNM	0.150	0.444	0.504	0.459	0.482	0.474	0.504	0.489	0.519
0.70 UNM	0.175	0.518	0.586	0.535	0.560	0.552	0.586	0.569	0.603
0.80 UNM	0.200	0.592	0.668	0.611	0.640	0.630	0.668	0.649	0.687
0.90 UNM	0.225	0.666	0.750	0.687	0.718	0.708	0.750	0.729	0.771
1.00 UNM	0.250	0.740	0.832	0.763	0.798	0.786	0.832	0.809	0.855
1.10 UNM	0.250	0.840	0.932	0.863	0.898	0.886	0.932	0.909	0.955
1.20 UNM	0.250	0.940	1.032	0.963	0.998	0.986	1.032	1.009	1.055
1.40 UNM	0.300	1.088	1.196	1.115	1.156	1.142	1.196	1.169	1.223
Designation	Thds. per in.	inch	inch	inch	inch	inch	inch	inch	inch
0.30 UNM	318	0.0085	0.0100	0.0089	0.0095	0.0093	0.0100	0.0096	0.0104
0.35 UNM	282	0.0101	0.0117	0.0105	0.0111	0.0109	0.0117	0.0113	0.0121
0.40 UNM	254	0.0117	0.0134	0.0121	0.0127	0.0125	0.0134	0.0130	0.0138
0.45 UNM	254	0.0136	0.0154	0.0141	0.0147	0.0145	0.0154	0.0149	0.0158
0.50 UNM	203	0.0146	0.0166	0.0150	0.0158	0.0156	0.0166	0.0161	0.0171
0.55 UNM	203	0.0165	0.0186	0.0170	0.0178	0.0176	0.0186	0.0181	0.0191
0.60 UNM	169	0.0175	0.0198	0.0181	0.0190	0.0187	0.0198	0.0193	0.0204
0.70 UNM	145	0.0204	0.0231	0.0211	0.0221	0.0217	0.0231	0.0224	0.0237
0.80 UNM	127	0.0233	0.0263	0.0241	0.0252	0.0248	0.0263	0.0256	0.0270
0.90 UNM	113	0.0262	0.0295	0.0270	0.0283	0.0279	0.0295	0.0287	0.0304
1.00 UNM	102	0.0291	0.0327	0.0300	0.0314	0.0309	0.0327	0.0319	0.0337
1.10 UNM	102	0.0331	0.0367	0.0340	0.0354	0.0349	0.0367	0.0358	0.0376
1.20 UNM	102	0.0370	0.0406	0.0379	0.0393	0.0388	0.0406	0.0397	0.0415
1.40 UNM	85	0.0428	0.0471	0.0439	0.0455	0.0450	0.0471	0.0460	0.0481

As an aid in selecting suitable drills, see the listing of American Standard drill sizes in the twist drill section. Thread sizes in heavy type are preferred sizes.

Hole Sizes for Tapping Unified Miniature Screw Threads.—Table 5 indicates the hole size limits recommended for tapping. These limits are derived from the internal thread minor diameter limits given in the American Standard for Unified Miniature Screw Threads ASA B1.10-1958 and are disposed so as to provide the optimum conditions for tapping. The maximum limits are based on providing a functionally adequate fastening for the most common applications, where the material of the externally threaded member is of a strength essentially equal to or greater than that of its mating part. In applications where, because of considerations other than the fastening, the screw is made of an appreciably

weaker material, the use of smaller hole sizes is usually necessary to extend thread engagement to a greater depth on the external thread. Recommended minimum hole sizes are greater than the minimum limits of the minor diameters to allow for the spin-up developed in tapping.

In selecting drills to produce holes within the limits given in Table 5 it should be recognized that drills have a tendency to cut oversize. The material on page 873 may be used as a guide to the expected amount of oversize.

British Standard Tapping Drill Sizes for Screw and Pipe Threads.—British Standard BS 1157:1975 (2004) provides recommendations for tapping drill sizes for use with fluted taps for various ISO metric, Unified, British Standard fine, British Association, and British Standard Whitworth screw threads as well as British Standard parallel and taper pipe threads.

Table 6. British Standard Tapping Drill Sizes for ISO Metric Coarse Pitch Series Threads BS 1157:1975 (2004)

Nom. Size and Thread Diam.	Standard Drill Sizes ^a				Nom. Size and Thread Diam.	Standard Drill Sizes ^a			
	Recommended		Alternative			Recommended		Alternative	
	Size	Theoretical Radial Engagement with Ext. Thread (Per Cent)	Size	Theoretical Radial Engagement with Ext. Thread (Per Cent)		Size	Theoretical Radial Engagement with Ext. Thread (Per Cent)	Size	Theoretical Radial Engagement with Ext. Thread (Per Cent)
M 1	0.75	81.5	0.78	71.7	M 12	10.20	83.7	10.40	74.5 ^b
M 1.1	0.85	81.5	0.88	71.7	M 14	12.00	81.5	12.20	73.4 ^b
M 1.2	0.95	81.5	0.98	71.7	M 16	14.00	81.5	14.25	71.3 ^c
M 1.4	1.10	81.5	1.15	67.9	M 18	15.50	81.5	15.75	73.4 ^c
M 1.6	1.25	81.5	1.30	69.9	M 20	17.50	81.5	17.75	73.4 ^c
M 1.8	1.45	81.5	1.50	69.9	M 22	19.50	81.5	19.75	73.4 ^c
M 2	1.60	81.5	1.65	71.3	M 24	21.00	81.5	21.25	74.7 ^b
M 2.2	1.75	81.5	1.80	72.5	M 27	24.00	81.5	24.25	74.7 ^b
M 2.5	2.05	81.5	2.10	72.5	M 30	26.50	81.5	26.75	75.7 ^b
M 3	2.50	81.5	2.55	73.4	M 33	29.50	81.5	29.75	75.7 ^b
M 3.5	2.90	81.5	2.95	74.7	M 36	32.00	81.5
M 4	3.30	81.5	3.40	69.9 ^b	M 39	35.00	81.5
M 4.5	3.70	86.8	3.80	76.1	M 42	37.50	81.5
M 5	4.20	81.5	4.30	71.3 ^b	M 45	40.50	81.5
M 6	5.00	81.5	5.10	73.4	M 48	43.00	81.5
M 7	6.00	81.5	6.10	73.4	M 52	47.00	81.5
M 8	6.80	78.5	6.90	71.7 ^b	M 56	50.50	81.5
M 9	7.80	78.5	7.90	71.7 ^b	M 60	54.50	81.5
M 10	8.50	81.5	8.60	76.1	M 64	58.00	81.5
M 11	9.50	81.5	9.60	76.1	M 68	62.00	81.5

^aThese tapping drill sizes are for fluted taps only.

^bFor tolerance class 6H and 7H threads only.

^cFor tolerance class 7H threads only.

Drill sizes are given in millimeters.

In the accompanying Table 6, recommended and alternative drill sizes are given for producing holes for ISO metric coarse pitch series threads. These coarse pitch threads are suitable for the large majority of general-purpose applications, and the limits and tolerances for internal coarse threads are given in the table starting on page 1824. It should be noted that Table 6 is for fluted taps only since a fluteless tap will require for the same screw thread a different size of twist drill than will a fluted tap. When tapped, holes produced with drills of the recommended sizes provide for a theoretical radial engagement with the external thread of about 81 per cent in most cases. Holes produced with drills of the alternative sizes provide for a theoretical radial engagement with the external thread of about 70 to 75

per cent. In some cases, as indicated in Table 6, the alternative drill sizes are suitable only for medium (6H) or for free (7H) thread tolerance classes.

When relatively soft material is being tapped, there is a tendency for the metal to be squeezed down towards the root of the tap thread, and in such instances, the minor diameter of the tapped hole may become smaller than the diameter of the drill employed. Users may wish to choose different tapping drill sizes to overcome this problem or for special purposes, and reference can be made to the pages mentioned above to obtain the minor diameter limits for internal pitch series threads.

Reference should be made to this standard BS 1157:1975 (2004) for recommended tapping hole sizes for other types of British Standard screw threads and pipe threads.

Table 7. British Standard Metric Bolt and Screw Clearance Holes BS 4186: 1967

Nominal Thread Diameter	Clearance Hole Sizes			Nominal Thread Diameter	Clearance Hole Sizes		
	Close Fit Series	Medium Fit Series	Free Fit Series		Close Fit Series	Medium Fit Series	Free Fit Series
1.6	1.7	1.8	2.0	52.0	54.0	56.0	62.0
2.0	2.2	2.4	2.6	56.0	58.0	62.0	66.0
2.5	2.7	2.9	3.1	60.0	62.0	66.0	70.0
3.0	3.2	3.4	3.6	64.0	66.0	70.0	74.0
4.0	4.3	4.5	4.8	68.0	70.0	74.0	78.0
5.0	5.3	5.5	5.8	72.0	74.0	78.0	82.0
6.0	6.4	6.6	7.0	76.0	78.0	82.0	86.0
7.0	7.4	7.6	8.0	80.0	82.0	86.0	91.0
8.0	8.4	9.0	10.0	85.0	87.0	91.0	96.0
10.0	10.5	11.0	12.0	90.0	93.0	96.0	101.0
12.0	13.0	14.0	15.0	95.0	98.0	101.0	107.0
14.0	15.0	16.0	17.0	100.0	104.0	107.0	112.0
16.0	17.0	18.0	19.0	105.0	109.0	112.0	117.0
18.0	19.0	20.0	21.0	110.0	114.0	117.0	122.0
20.0	21.0	22.0	24.0	115.0	119.0	122.0	127.0
22.0	23.0	24.0	26.0	120.0	124.0	127.0	132.0
24.0	25.0	26.0	28.0	125.0	129.0	132.0	137.0
27.0	28.0	30.0	32.0	130.0	134.0	137.0	144.0
30.0	31.0	33.0	35.0	140.0	144.0	147.0	155.0
33.0	34.0	36.0	38.0	150.0	155.0	158.0	165.0
36.0	37.0	39.0	42.0
39.0	40.0	42.0	45.0
42.0	43.0	45.0	48.0
45.0	46.0	48.0	52.0
48.0	50.0	52.0	56.0

All dimensions are given in millimeters.

British Standard Clearance Holes for Metric Bolts and Screws.—The dimensions of the clearance holes specified in this British Standard BS 4186:1967 have been chosen in such a way as to require the use of the minimum number of drills. The recommendations cover three series of clearance holes, namely close fit (H 12), medium fit (H 13), and free fit (H 14) and are suitable for use with bolts and screws specified in the following metric British Standards: BS 3692, ISO metric precision hexagon bolts, screws, and nuts; BS 4168, Hexagon socket screws and wrench keys; BS 4183, Machine screws and machine screw nuts; and BS 4190, ISO metric black hexagon bolts, screws, and nuts. The sizes are in accordance with those given in ISO Recommendation R273, and the range has been extended up to 150 millimeters diameter in accordance with an addendum to that recommendation. The selection of clearance holes sizes to suit particular design requirements

can of course be dependent upon many variable factors. It is however felt that the medium fit series should suit the majority of general purpose applications. In the Standard, limiting dimensions are given in a table which is included for reference purposes only, for use in instances where it may be desirable to specify tolerances.

To avoid any risk of interference with the radius under the head of bolts and screws, it is necessary to countersink slightly all recommended clearance holes in the close and medium fit series. Dimensional details for the radius under the head of fasteners made according to BS 3692 are given on page 1537; those for fasteners to BS 4168 are given on page 1601; those to BS 4183 are given on pages 1575 through 1579.

Cold Form Tapping.—Cold form taps do not have cutting edges or conventional flutes; the threads on the tap form the threads in the hole by displacing the metal in an extrusion or swaging process. The threads thus produced are stronger than conventionally cut threads because the grains in the metal are unbroken and the displaced metal is work hardened. The surface of the thread is burnished and has an excellent finish. Although chip problems are eliminated, cold form tapping does displace the metal surrounding the hole and countersinking or chamfering before tapping is recommended. Cold form tapping is not recommended if the wall thickness of the hole is less than two-thirds of the nominal diameter of the thread. If possible, blind holes should be drilled deep enough to permit a cold form tap having a four thread lead to be used as this will require less torque, produce less burr surrounding the hole, and give a greater tool life.

The operation requires 0 to 50 per cent more torque than conventional tapping, and the cold form tap will pick up its own lead when entering the hole; thus, conventional tapping machines and tapping heads can be used. Another advantage is the better tool life obtained. The best results are obtained by using a good lubricating oil instead of a conventional cutting oil.

The method can be applied only to relatively ductile metals, such as low-carbon steel, leaded steels, austenitic stainless steels, wrought aluminum, low-silicon aluminum die casting alloys, zinc die casting alloys, magnesium, copper, and ductile copper alloys. A higher than normal tapping speed can be used, sometimes by as much as 100 per cent.

Conventional tap drill sizes should not be used for cold form tapping because the metal is displaced to form the thread. The cold formed thread is stronger than the conventionally tapped thread, so the thread height can be reduced to 60 per cent without much loss of strength; however, the use of a 65 per cent thread is strongly recommended. The following formula is used to calculate the theoretical hole size for cold form tapping:

$$\text{Theoretical hole size} = \text{basic tap O.D.} - \frac{0.0068 \times \text{per cent of full thread}}{\text{threads per inch}}$$

The theoretical hole size and the tap drill sizes for American Unified threads are given in Table 8, and Table 9 lists drills for ISO metric threads. Sharp drills should be used to prevent cold working the walls of the hole, especially on metals that are prone to work hardening. Such damage may cause the torque to increase, possibly stopping the machine or breaking the tap. On materials that can be die cast, cold form tapping can be done in cored holes provided the correct core pin size is used. The core pins are slightly tapered, so the theoretical hole size should be at the position on the pin that corresponds to one-half of the required engagement length of the thread in the hole. The core pins should be designed to form a chamfer on the hole to accept the vertical extrusion.

Table 8. Theoretical and Tap Drill or Core Hole Sizes for Cold Form Tapping Unified Threads

Tap Size	Threads Per Inch	Percentage of Full Thread								
		75			65			55		
		Theor. Hole Size	Nearest Drill Size	Dec. Equiv.	Theor. Hole Size	Nearest Drill Size	Dec. Equiv.	Theor. Hole Size	Nearest Drill Size	Dec. Equiv.
0	80	0.0536	1.35 mm	0.0531	0.0545	0.0554	54	0.055
1	64	0.0650	1.65 mm	0.0650	0.0661	0.0672	51	0.0670
	72	0.0659	1.65 mm	0.0650	0.0669	1.7 mm	0.0669	0.0679	51	0.0670
	56	0.0769	1.95 mm	0.0768	0.0781	$\frac{5}{64}$	0.0781	0.0794	2.0 mm	0.0787
2	64	0.0780	$\frac{5}{64}$	0.0781	0.0791	2.0 mm	0.0787	0.0802
	48	0.0884	2.25 mm	0.0886	0.0898	43	0.089	0.0913	2.3 mm	0.0906
3	56	0.0889	43	0.089	0.0911	2.3 mm	0.0906	0.0924	2.35 mm	0.0925
	40	0.0993	2.5 mm	0.0984	0.1010	39	0.0995	0.1028	2.6 mm	0.1024
4	48	0.0104	38	0.1015	0.1028	2.6 mm	0.1024	0.1043	37	0.1040
	5	40	0.1123	34	0.1110	0.1140	33	0.113	0.1158	32
5	44	0.1134	33	0.113	0.1150	2.9 mm	0.1142	0.1166	32	...
	32	0.1221	3.1 mm	0.1220	0.1243	0.1264	3.2 mm	0.1260
	40	0.1253	$\frac{1}{8}$	0.1250	0.1270	3.2 mm	0.1260	0.1288	30	0.1285
8	32	0.1481	3.75 mm	0.1476	0.1503	25	0.1495	0.1524	24	0.1520
	36	0.1498	25	0.1495	0.1518	24	0.1520	0.1537	3.9 mm	0.1535
10	24	0.1688	0.1717	$\frac{11}{64}$	0.1719	0.1746	17	0.1730
	32	0.1741	17	0.1730	0.1763	0.1784	4.5 mm	0.1772
12	24	0.1948	10	0.1935	0.1977	5.0 mm	0.1968	0.2006	5.1 mm	0.2008
	28	0.1978	5.0 mm	0.1968	0.2003	8	0.1990	0.2028
$\frac{1}{4}$	20	0.2245	5.7 mm	0.2244	0.2280	1	0.2280	0.2315
	28	0.2318	0.2343	A	0.2340	0.2368	6.0 mm	0.2362
$\frac{5}{16}$	18	0.2842	7.2 mm	0.2835	0.2879	7.3 mm	0.2874	0.2917	7.4 mm	0.2913
	24	0.2912	7.4 mm	0.2913	0.2941	M	0.2950	0.2969	$\frac{19}{64}$	0.2969
$\frac{3}{8}$	16	0.3431	$\frac{11}{32}$	0.3437	0.3474	S	0.3480	0.3516
	24	0.3537	9.0 mm	0.3543	0.3566	0.3594	$\frac{23}{64}$	0.3594
$\frac{7}{16}$	14	0.4011	0.4059	$\frac{13}{32}$	0.4062	0.4108
	20	0.4120	Z	0.413	0.4154	0.4188
$\frac{1}{2}$	13	0.4608	0.4660	0.4712	12 mm	0.4724
	20	0.4745	0.4779	0.4813
$\frac{9}{16}$	12	0.5200	0.5257	0.5313	$\frac{17}{32}$	0.5312
	18	0.5342	13.5 mm	0.5315	0.5380	0.5417
$\frac{5}{8}$	11	0.5787	$\frac{31}{64}$	0.5781	0.5848	0.5910	15 mm	0.5906
	18	0.5976	$\frac{19}{32}$	0.5937	0.6004	0.6042
$\frac{3}{4}$	10	0.6990	0.7058	$\frac{45}{64}$	0.7031	0.7126
	16	0.7181	$\frac{23}{32}$	0.7187	0.7224	0.7266

Table 9. Tap Drill or Core Hole Sizes for Cold Form Tapping ISO Metric Threads

Nominal Size of Tap	Pitch	Recommended Tap Drill Size
1.6 mm	0.35 mm	1.45 mm
1.8 mm	0.35 mm	1.65 mm
2.0 mm	0.40 mm	1.8 mm
2.2 mm.	0.45 mm	2.0 mm
2.5 mm	0.45 mm	2.3 mm
3.0 mm	0.50 mm	2.8 mm ^a
3.5 mm	0.60 mm	3.2 mm
4.0 mm	0.70 mm	3.7 mm
4.5 mm	0.75 mm	4.2 mm ^a
5.0 mm	0.80 mm	4.6 mm
6.0 mm	1.00 mm	5.6 mm ^a
7.0 mm	1.00 mm	6.5 mm
8.0 mm	1.25 mm	7.4 mm
10.0 mm	1.50 mm	9.3 mm

^a These diameters are the nearest stocked drill sizes and not the theoretical hole size, and may not produce 60 to 75 per cent full thread.

The sizes are calculated to provide 60 to 75 per cent of full thread.

Removing a Broken Tap.—Broken taps can be removed by electrodischarge machining (EDM), and this method is recommended when available. When an EDM machine is not available, broken taps may be removed by using a tap extractor, which has fingers that enter the flutes of the tap; the tap is backed out of the hole by turning the extractor with a wrench. Sometimes the injection of a small amount of a proprietary solvent into the hole will be helpful. A solvent can be made by diluting about one part nitric acid with five parts water. The action of the proprietary solvent or the diluted nitric acid on the steel loosens the tap so that it can be removed with pliers or with a tap extractor. The hole should be washed out afterwards so that the acid will not continue to work on the part. Another method is to add, by electric arc welding, additional metal to the shank of the broken tap, above the level of the hole. Care must be taken to prevent depositing metal on the threads in the tapped hole. After the shank has been built up, the head of a bolt or a nut is welded to it and then the tap may be backed out.

Tap Drills for Pipe Taps

Size of Tap	Drills for Briggs Pipe Taps	Drills for Whitworth Pipe Taps	Size of Tap	Drills for Briggs Pipe Taps	Drills for Whitworth Pipe Taps	Size of Tap	Drills for Briggs Pipe Taps	Drills for Whitworth Pipe Taps
1/8	1/32	5/16	1 1/4	1 1/2	1 5/32	3 1/4	...	3 1/2
1/4	7/16	27/64	1 1/2	1 25/32	1 29/32	3 3/4	3 3/4	3 3/4
3/8	9/32	9/16	1 3/4	...	1 5/16	3 3/4	...	4
1/2	23/32	11/16	2	2 3/16	2 5/32	4	4 1/4	4 1/4
5/8	...	25/32	2 1/4	...	2 13/32	4 1/2	4 3/4	4 3/4
3/4	15/16	29/32	2 1/2	2 5/8	2 25/32	5	5 5/16	5 1/4
7/8	...	1 1/16	2 3/4	...	3 1/32	5 1/2	...	5 3/4
1	1 5/32	1 1/8	3	3 1/4	3 3/32	6	6 3/8	6 1/4

All dimensions are in inches.

To secure the best results, the hole should be reamed before tapping with a reamer having a taper of 3/4 inch per foot.

Power for Pipe Taps.—The power required for driving pipe taps is given in the following table, which includes nominal pipe tap sizes from 2 to 8 inches.

The holes to be tapped were reamed with standard pipe tap reamers before tapping. The horsepower recorded was read off just before the tap was reversed. The table gives the net horsepower, deductions being made for the power required to run the machine without a load. The material tapped was cast iron, except in two instances, where cast steel was tapped. It will be seen that nearly double the power is required for tapping cast steel. The

power varies, of course, with the conditions. More power than that indicated in the table will be required if the cast iron is of a harder quality or if the taps are not properly relieved. The taps used in these experiments were of the inserted-blade type, the blades being made of high-speed steel.

Power Required for Pipe Taps

Nominal Tap Size	Rev. per Min.	Net H.P.	Thickness of Metal	Nominal Tap Size	Rev. per Min.	Net H.P.	Thickness of Metal
2	40	4.24	1 $\frac{1}{8}$	3 $\frac{1}{2}$	25.6	7.20	1 $\frac{3}{4}$
2 $\frac{1}{2}$	40	5.15	1 $\frac{1}{8}$	4	18	6.60	2
2 $\frac{1}{2}$	38.5	9.14	1 $\frac{1}{8}$	5	18	7.70	2
3	40	5.75	1 $\frac{1}{8}$	6	17.8	8.80	2
3	38.5	9.70	1 $\frac{1}{8}$	8	14	7.96	2 $\frac{1}{2}$

^aTapping cast steel; other tests in cast iron.

Tap size and metal thickness are in inches.

High-Speed CNC Tapping.—Tapping speed depends on the type of material being cut, the type of cutting tool, the speed and rigidity of the machine, the rigidity of the part-holding fixture, and the proper use of coolants and cutting fluids. When tapping, each revolution of the tool feeds the tap a distance equal to the thread pitch. Both spindle speed and feed per revolution must be accurately controlled so that changes in spindle speed result in a corresponding change in feed rate. If the feed/rev is not right, a stripped thread or broken tap will result. NC/CNC machines equipped with the *synchronous tapping* feature are able to control the tap feed as a function of spindle speed. These machines can use rigid-type tap holders or automatic tapping attachments and are able to control depth very accurately. Older NC machines that are unable to reliably coordinate spindle speed and feed must use a tension-compression type tapping head that permits some variation of the spindle speed while still letting the tap feed at the required rate.

CNC machines capable of synchronous tapping accurately coordinate feed rate and rotational speed so that the tap advances at the correct rate regardless of the spindle speed. A canned tapping cycle (see *Right Hand Thread (G84)* and *Left Hand Thread (G74)* on page 1242 in the **CNC NUMERICAL CONTROL PROGRAMMING** section) usually controls the operation, and feed and speed are set by the machine operator or part programmer. Synchronized tapping requires reversing the tapping spindle twice for each hole tapped, once after finishing the cut and again at the end of the cycle. Because the rotating mass is fairly large (motor, spindle, chuck or tap holder, and tap), the acceleration and deceleration of the tap are rather slow and a lot of time is lost by this process. The frequent changes in cutting speed during the cut also accelerate tap wear and reduce tap life.

A self-reversing tapping attachment has a forward drive that rotates in the same direction as the machine spindle, a reverse drive that rotates in the opposite direction, and a neutral position in between the two. When a hole is tapped, the spindle feeds at a slightly slower rate than the tap to keep the forward drive engaged until the tap reaches the bottom of the hole. Through holes are tapped by feeding to the desired depth and then retracting the spindle, which engages the tapping-head reverse drive and backs the tap out of the hole—the spindle does not need to be reversed. For tapping blind holes, the spindle is fed to a depth equal to the thread depth minus the self-feed of the tapping attachment. When the spindle is retracted (without reversing), the tap continues to feed forward a short distance (the tapping head self-feed distance) before the reverse drive engages and reverse drives the tap out of the hole. The depth can be controlled to within about $\frac{1}{4}$ revolution of the tap. The tapping cycle normally used for the self-reversing tap attachment is a standard boring cycle with feed return and no dwell. A typical programming cycle is illustrated with a G85 block on page 1242. The inward feed is set to about 95 per cent of the normal tapping feed (i.e.,

95 per cent of the pitch per revolution). Because the tap is lightweight, tap reversal is almost instantaneous and tapping speed is very fast compared with synchronous tapping.

Tapping speeds are usually given in surface feet per minute (sfm) or the equivalent feet per minute (fpm or ft/min), so a conversion is necessary to get the spindle speed in revolutions per minute. The tapping speed in rpm depends on the diameter of the tap, and is given by the following formula:

$$\text{rpm} = \frac{\text{sfm} \times 12}{d \times 3.14159} = \frac{\text{sfm} \times 3.82}{d}$$

where d is the nominal diameter of the tap in inches. As indicated previously, the feed in in/rev is equal to the thread pitch and is independent of the cutting speed. The feed rate in inches per minute is found by dividing the tapping speed in rpm by the number of threads per inch, or by multiplying the speed in rpm by the pitch or feed per revolution:

$$\text{feed rate (in/min)} = \frac{\text{rpm}}{\text{threads per inch}} = \text{rpm} \times \text{thread pitch} = \text{rpm} \times \text{feed/rev}$$

Example: If the recommended tapping speed for 1020 steel is given as 45 to 60 sfm, find the required spindle speed and feed rate for tapping a 1/4–20 UNF thread in 1020 steel.

Assuming that the machine being used is in good condition and rigid, and the tap is sharp, use the higher rate of 60 sfm and calculate the required spindle speed and feed rate as follows:

$$\text{speed} = \frac{60 \times 3.82}{0.25} = 916.8 \approx 920 \text{ rpm} \quad \text{feed rate} = \frac{920}{20} = 46 \text{ in/min}$$

Coolant for Tapping.—Proper use of through-the-tap high-pressure coolant/lubricant can result in increased tap life, increased speed and feed, and more accurate threads. In most chip-cutting processes, cutting fluid is used primarily as a coolant, with lubrication being a secondary but important benefit. Tapping, however, requires a cutting fluid with lubricity as the primary property and coolant as a secondary benefit. Consequently, the typical blend of 5 per cent coolant concentrate to 95 per cent water is too low for best results. An increased percentage of concentrate in the blend helps the fluid to cling to the tap, providing better lubrication at the cutting interface. A method of increasing the tap lubrication qualities without changing the concentration of the primary fluid blend is to use a cutting fluid dispenser controlled by an M code different from that used to control the high-pressure flood coolant (for example, use an M08 code in addition to M07). The secondary coolant-delivery system applies a small amount of an edge-type cutting fluid (about a drop at a time) directly onto the tap-cutting surfaces providing the lubrication needed for cutting. The edge-type fluid applied in this way clings to the tap, increasing the lubrication effect and ensuring that the cutting fluid becomes directly involved in the cutting action at the shear zone.

High-pressure coolant fed through the tap is important in many high-volume tapping applications. The coolant is fed directly through the spindle or tool holder to the cutting zone, greatly improving the process of chip evacuation and resulting in better thread quality. High-pressure through-the-tap coolant flushes blind holes before the tap enters and can remove chips from the holes after tapping is finished. The flushing action prevents chip recutting by forcing chips through the flutes and back out of the hole, improving the surface of the thread and increasing tap life. By improving lubrication and reducing heat and friction, the use of high-pressure coolant may result in increased tap life up to five times that of conventional tapping and may permit speed and feed increases that reduce overall cycle time.

Combined Drilling and Tapping.—A special tool that drills and taps in one operation can save a lot of time by reducing setup and eliminating a secondary operation in some

applications. A combination drill and tap can be used for through holes if the length of the fluted drill section is greater than the material thickness, but cannot be used for drilling and tapping blind holes because the tip (drill point) must cut completely through the material before the tapping section begins to cut threads. Drilling and tapping depths up to twice the tool diameter are typical. Determine the appropriate speed by starting the tool at the recommended speed for the tap size and material, and adjust the speed higher or lower to suit the application. Feed during tapping is dependent on the thread pitch. NC/CNC programs can use a fast drilling speed and a slower tapping speed to combine both operations into one and minimize cutting time.

Relief Angles for Single-Point Thread Cutting Tools.—The surface finish on threads cut with single-point thread cutting tools is influenced by the relief angles on the tools. The leading and trailing cutting edges that form the sides of the thread, and the cutting edge at the nose of the tool must all be provided with an adequate amount of relief. Moreover, it is recommended that the effective relief angle, a_e , for all of these cutting edges be made equal, although the practice in some shops is to use slightly less relief at the trailing cutting edge. While too much relief may weaken the cutting edge, causing it to chip, an inadequate amount of relief will result in rough threads and in a shortened tool life. Other factors that influence the finish produced on threads include the following: the work material; the cutting speed; the cutting fluid used; the method used to cut the thread; and, the condition of the cutting edge.

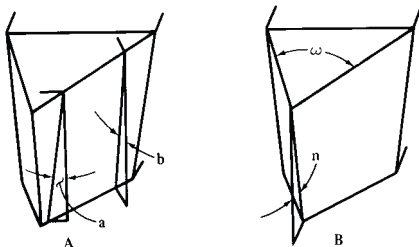

Two similar diagrams showing relationships of various relief angles of thread cutting tools

Relief angles on single-point thread cutting tools are often specified on the basis of experience. While this method may give satisfactory results in many instances, better results can usually be obtained by calculating these angles, using the formulas provided further on. When special high helix angle threads are to be cut, the magnitude of the relief angles should always be calculated. These calculations are based on the effective relief angle, a_e ; this is the angle between the flank of the tool and the sloping sides of the thread, measured in a direction parallel to the axis of the thread. Recommended values of this angle are 8 to 14 degrees for high speed steel tools, and 5 to 10 degrees for cemented carbide tools. The larger values are recommended for cutting threads on soft and gummy materials, and the smaller values are for the harder materials, which inherently take a better surface finish. Harder materials also require more support below the cutting edges, which is provided by using a smaller relief angle. These values are recommended for the relief angle below the cutting edge at the nose without any further modification. The angles below the leading and trailing side cutting edges are modified, using the formulas provided. The angles b and b' are the relief angles actually ground on the tool below the leading and trailing side cutting edges respectively; they are measured perpendicular to the side cutting edges. When designing or grinding the thread cutting tool, it is sometimes helpful to know the magnitude of the angle, n , for which a formula is provided. This angle would occur only in the event that the tool were ground to a sharp point. It is the angle of the edge formed by the intersection of the flank surfaces.

$$\tan \phi = \frac{\text{lead of thread}}{\pi K} \quad \tan \phi' = \frac{\text{lead of thread}}{\pi D}$$

$$a = a_e + \phi$$

$$a' = a_e - \phi'$$

$$\tan b = \tan a \cos \frac{1}{2}\omega$$

$$\tan b' = \tan a' \cos \frac{1}{2}\omega$$

$$\tan n = \frac{\tan a - \tan a'}{2 \tan \frac{1}{2}\omega}$$

where θ = helix angle of thread at minor diameter

θ' = helix angle of thread at major diameter

K = minor diameter of thread

D = major diameter of thread

a = side relief angle parallel to thread axis at leading edge of tool

a' = side relief angle parallel to thread axis at trailing edge of tool

a_e = effective relief angle

b = side relief angle perpendicular to leading edge of tool

b' = side relief angle perpendicular to trailing edge of tool

ω = included angle of thread cutting tool

n = nose angle resulting from intersection of flank surfaces

Example: Calculate the relief angles and the nose angle n for a single-point thread cutting tool that is to be used to cut a 1-inch diameter, 5-threads-per-inch, double Acme thread. The lead of this thread is $2 \times 0.200 = 0.400$ inch. The included angle ω of this thread is 29 degrees, the minor diameter K is 0.780 inch, and the effective relief angle a_e below all cutting edges is to be 10 degrees.

$$\tan \phi = \frac{\text{lead of thread}}{\pi K} = \frac{0.400}{\pi \times 0.780}$$

$$\phi = 9.27^\circ (9^\circ 16')$$

$$\tan \phi' = \frac{\text{lead of thread}}{\pi D} = \frac{0.400}{\pi \times 1.000}$$

$$\phi' = 7.26^\circ (7^\circ 15')$$

$$a = a_e + \phi = 10^\circ + 9.27^\circ = 19.27^\circ$$

$$a' = a_e - \phi' = 10^\circ - 7.26^\circ = 2.74^\circ$$

$$\tan b = \tan a \cos \frac{1}{2}\omega = \tan 19.27 \cos 14.5$$

$$b = 18.70^\circ (18^\circ 42')$$

$$\tan b' = \tan a' \cos \frac{1}{2}\omega = \tan 2.74 \cos 14.5$$

$$b' = 2.65^\circ (2^\circ 39')$$

$$\tan n = \frac{\tan a - \tan a'}{2 \tan \frac{1}{2}\omega} = \frac{\tan 19.27 - \tan 2.74}{2 \tan 14.5}$$

$$n = 30.26^\circ (30^\circ 16')$$

Lathe Change Gears

Change Gears for Thread Cutting.—To determine the change gears to use for cutting a thread of given pitch, first find what number of threads per inch will be cut when gears of the same size are placed on the lead screw and spindle stud, either by trial or by referring to the index plate; then multiply this number, called the “lathe screw constant,” by some trial number to obtain the number of teeth in the gear for the spindle stud, and multiply the threads per inch to be cut by the *same* trial number to obtain the number of teeth in the gear for the lead screw. Expressing this rule as a formula:

$$\frac{\text{Trial number} \times \text{lathe screw constant}}{\text{Trial number} \times \text{threads per inch to be cut}} = \frac{\text{teeth in gear on spindle stud}}{\text{teeth in gear on lead screw}}$$

For example, suppose the available change gears supplied with the lathe have 24, 28, 32, 36 teeth, etc., the number increasing by 4 up to 100, and that 10 threads per inch are to be cut in a lathe having a lathe screw constant of 6; then, if the screw constant is written as the numerator, the number of threads per inch to be cut as the denominator of a fraction, and both numerator and denominator are multiplied by some trial number, say, 4, it is found that gears having 24 and 40 teeth can be used. Thus:

$$\frac{6}{10} = \frac{6 \times 4}{10 \times 4} = \frac{24}{40}$$

The 24-tooth gear goes on the spindle stud and the 40-tooth gear on the lead screw.

The lathe screw constant is, of course, equal to the number of threads per inch on the lead screw, provided the spindle stud and spindle are geared in the ratio of 1 to 1, which, however, is not always so.

Compound Gearing.—To find the change gears used in compound gearing, place the screw constant as the numerator and the number of threads per inch to be cut as the denominator of a fraction; resolve both numerator and denominator into two factors each, and multiply each “pair” of factors by the same number, until values are obtained representing suitable numbers of teeth for the change gears. (One factor in the numerator and one in the denominator make a “pair” of factors.)

Example:— $1\frac{3}{4}$ threads per inch are to be cut in a lathe having a screw constant of 8; the available gears have 24, 28, 32, 36, 40 teeth, etc., increasing by 4 up to 100. Following the rule:

$$\frac{8}{1\frac{3}{4}} = \frac{2 \times 4}{1 \times 1\frac{3}{4}} = \frac{(2 \times 36) \times (4 \times 16)}{(1 \times 36) \times (1\frac{3}{4} \times 16)} = \frac{72 \times 64}{36 \times 28}$$

The gears having 72 and 64 teeth are the *driving* gears and those with 36 and 28 teeth are the *driven* gears.

Fractional Threads.—Sometimes the lead of a thread is given as a fraction of an inch instead of stating the number of threads per inch. For example, a thread may be required to be cut, having $\frac{3}{8}$ inch lead. The expression “ $\frac{3}{8}$ inch lead” should first be transformed to “number of threads per inch.” The number of threads per inch (the thread being single) equals:

$$\frac{1}{\frac{3}{8}} = 1 \div \frac{3}{8} = \frac{8}{3} = 2\frac{2}{3}$$

To find the change gears to cut $2\frac{2}{3}$ threads per inch in a lathe having a screw constant 8 and change gears ranging from 24 to 100 teeth, increasing in increments of 4, proceed as below:

$$\frac{8}{2\frac{2}{3}} = \frac{2 \times 4}{1 \times 2\frac{2}{3}} = \frac{(2 \times 36) \times (4 \times 24)}{(1 \times 36) \times (2\frac{2}{3} \times 24)} = \frac{72 \times 96}{36 \times 64}$$

Change Gears for Metric Pitches.—When screws are cut in accordance with the metric system, it is the usual practice to give the lead of the thread in millimeters, instead of the number of threads per unit of measurement. To find the change gears for cutting metric threads, when using a lathe having an inch lead screw, first determine the number of threads per inch corresponding to the given lead in millimeters. Suppose a thread of 3 millimeters lead is to be cut in a lathe having an inch lead screw and a screw constant of 6. As there are 25.4 millimeters per inch, the number of threads per inch will equal $25.4 \div 3$. Place the screw constant as the numerator, and the number of threads per inch to be cut as the denominator:

$$\frac{6}{\frac{25.4}{3}} = 6 \div \frac{25.4}{3} = \frac{6 \times 3}{25.4}$$

The numerator and denominator of this fractional expression of the change gear ratio is next multiplied by some trial number to determine the size of the gears. The first whole number by which 25.4 can be multiplied so as to get a whole number as the result is 5. Thus, $25.4 \times 5 = 127$. Hence, one gear having 127 teeth is always used when cutting metric threads with an inch lead screw. The other gear required has 90 teeth. Thus:

$$\frac{6 \times 3 \times 5}{25.4 \times 5} = \frac{90}{127}$$

Therefore, the following rule can be used to find the change gears for cutting metric pitches with an inch lead screw:

Rule: Place the lathe screw constant multiplied by the lead of the required thread in millimeters multiplied by 5 as the numerator of the fraction and 127 as the denominator. The product of the numbers in the numerator equals the number of teeth for the spindle-stud gear, and 127 is the number of teeth for the lead-screw gear.

If the lathe has a metric pitch lead screw, and a screw having a given number of threads per inch is to be cut, first find the "metric screw constant" of the lathe or the lead of thread in millimeters that would be cut with change gears of equal size on the lead screw and spindle stud; then the method of determining the change gears is simply the reverse of the one already explained for cutting a metric thread with an inch lead screw.

Rule: To find the change gears for cutting inch threads with a metric lead screw, place 127 in the numerator and the threads per inch to be cut, multiplied by the metric screw constant multiplied by 5 in the denominator; 127 is the number of teeth on the spindle-stud gear and the product of the numbers in the denominator equals the number of teeth in the lead-screw gear.

Threads per Inch Obtained with a Given Combination of Gears.—To determine the number of threads per inch that will be obtained with a given combination of gearing, multiply the lathe screw constant by the number of teeth in the *driven* gear (or by the product of the numbers of teeth in both driven gears of compound gearing), and divide the product thus obtained by the number of teeth in the *driving* gear (or by the product of the two driving gears of a compound train). The quotient equals the number of threads per inch.

Change Gears for Fractional Ratios.—When gear ratios cannot be expressed exactly in whole numbers that are within the range of ordinary gearing, the combination of gearing required for the fractional ratio may be determined quite easily, often by the "cancellation method." To illustrate this method, assume that the speeds of two gears are to be in the ratio of 3.423 to 1. The number 3.423 is first changed to $\frac{3423}{1000}$ to clear it of decimals. Then, in order to secure a fraction that can be reduced, 3423 is changed to 3420;

$$\frac{3420}{1000} = \frac{342}{100} = \frac{3 \times 2 \times 57}{2 \times 50} = \frac{3 \times 57}{1 \times 50}$$

Then, multiplying $\frac{3}{1}$ by some trial number, say, 24, the following gear combination is obtained:

$$\frac{72}{24} \times \frac{57}{50} = \frac{4104}{1200} = \frac{3.42}{1}$$

As the desired ratio is 3.423 to 1, there is an error of 0.003. When the ratios are comparatively simple, the cancellation method is not difficult and is frequently used; but by the logarithmic method to be described, more accurate results are usually possible.

Modifying the Quick-Change Gearbox Output.—On most modern lathes, the gear train connecting the headstock spindle with the lead screw contains a quick-change gearbox. Instead of using different change gears, it is only necessary to position the handles of the gearbox to adjust the speed ratio between the spindle and the lead screw in preparation for cutting a thread. However, a thread sometimes must be cut for which there is no quick-change gearbox setting. It is then necessary to modify the normal, or standard, gear ratio between the spindle and the gearbox by installing modifying change gears to replace the standard gears normally used. Metric and other odd pitch threads can be cut on lathes that have an inch thread lead screw and a quick-change gearbox having only settings for inch threads by using modifying-change gears in the gear train. Likewise, inch threads and other odd pitch threads can be cut on metric lead-screw lathes having a gearbox on which only metric thread settings can be made. Modifying-change gears also can be used for cutting odd pitch threads on lathes having a quick-change gearbox that has both inch and metric thread settings.

The sizes of the modifying-change gears can be calculated by formulas to be given later; they depend on the thread to be cut and on the setting of the quick-change gearbox. Many different sets of gears can be found for each thread to be cut. It is recommended that several calculations be made in order to find the set of gears that is most suitable for installation on the lathe. The modifying-change gear formulas that follow are based on the type of lead screw, i.e., whether the lead screw has inch or metric threads.

Metric Threads on Inch Lead-Screw Lathes: A 127-tooth translating gear must be used in the modifying-change gear train in order to be able to cut metric threads on inch lead-screw lathes. The formula for calculating the modifying change gears is:

$$\frac{5 \times \text{gearbox setting in thds/in.} \times \text{pitch in mm to be cut}}{127} = \frac{\text{driving gears}}{\text{driven gears}}$$

The numerator and denominator of this formula are multiplied by equal numbers, called trial numbers, to find the gears. If suitable gears cannot be found with one set, then another set of equal trial numbers is used. (Because these numbers are equal, such as 15/15 or 24/24, they are equal to the number one when thought of as a fraction; their inclusion has the effect of multiplying the formula by one, which does not change its value.) It is necessary to select the gearbox setting in threads per inch that must be used to cut the metric thread when using the gears calculated by the formula. One method is to select a quick-change gearbox setting that is close to the actual number of metric threads in a 1-inch length, called the equivalent threads per inch, which can be calculated by the following formula: Equivalent thds/in. = $25.4 \div$ pitch in millimeters to be cut.

Example: Select the quick-change gearbox setting and calculate the modifying change gears required to set up a lathe having an inch-thread lead screw in order to cut an M12 \times 1.75 metric thread.

$$\begin{aligned} \text{Equivalent thds/in.} &= \frac{25.4}{\text{pitch in mm to be cut}} = \frac{25.4}{1.75} = 1.45 \text{ (use 14 thds/in.)} \\ \frac{5 \times \text{gearbox setting in thds/in.} \times \text{pitch in mm to be cut}}{127} &= \frac{5 \times 14 \times 1.75}{127} \\ &= \frac{(24) \times 5 \times 14 \times 1.75}{(24) \times 127} = \frac{(5 \times 14) \times (24 \times 1.75)}{24 \times 127} \\ &= \frac{70 \times 42}{24 \times 127} = \frac{\text{driving gears}}{\text{driven gears}} \end{aligned}$$

Odd Inch Pitch Threads: The calculation of the modifying change gears used for cutting odd pitch threads that are specified by their pitch in inches involves the sizes of the standard gears, which can be found by counting their teeth. Standard gears are those used to enable the lathe to cut the thread for which the gearbox setting is made; they are the gears that are normally used. The threads on worms used with worm gears are among the odd pitch threads that can be cut by this method. As before, it is usually advisable to calculate the actual number of threads per inch of the odd pitch thread and to select a gearbox setting that is close to this value. The following formula is used to calculate the modifying-change gears to cut odd inch pitch threads:

$$\begin{aligned} \frac{\text{Standard driving gear} \times \text{pitch to be cut in inches} \times \text{gearbox setting in thds/in.}}{\text{Standard driven gear}} \\ = \frac{\text{driving gears}}{\text{driven gears}} \end{aligned}$$

Example: Select the quick-change gearbox setting and calculate the modifying change gears required to cut a thread having a pitch equal to 0.195 inch. The standard driving and driven gears both have 48 teeth. To find equivalent threads per inch:

$$\frac{\text{Thds}}{\text{in.}} = \frac{1}{\text{pitch}} = \frac{1}{0.195} = 5.13 \quad (\text{use 5 thds/in.})$$

$$\begin{aligned} \frac{\text{Standard driving gear} \times \text{pitch to be cut in inches} \times \text{gearbox setting in thds/in.}}{\text{Standard driven gear}} \\ = \frac{48 \times 0.195 \times 5}{48} = \frac{(1000) \times 0.195 \times 5}{(1000)} = \frac{195 \times 5}{500 \times 2} = \frac{39 \times 5}{100 \times 2} = \frac{39 \times 5 \times (8)}{50 \times 2 \times 2 \times (8)} \\ = \frac{39 \times 40}{50 \times 32} = \frac{\text{driving gears}}{\text{driven gears}} \end{aligned}$$

It will be noted that in the second step above, 1000/1000 has been substituted for 48/48. This substitution does not change the ratio. The reason for this substitution is that $1000 \times 0.195 = 195$, a whole number. Actually, $200/200$ might have been substituted because $200 \times 0.195 = 39$, also a whole number.

The procedure for calculating the modifying gears using the following formulas is the same as illustrated by the two previous examples.

Odd Threads per Inch on Inch Lead Screw Lathes:

$$\frac{\text{Standard driving gear} \times \text{gearbox setting in thds/in.}}{\text{Standard driven gear} \times \text{thds/in. to be cut}} = \frac{\text{driving gears}}{\text{driven gears}}$$

Inch Threads on Metric Lead Screw Lathes:

$$\frac{127}{5 \times \text{gearbox setting in mm pitch} \times \text{thds/in. to be cut}} = \frac{\text{driving gears}}{\text{driven gears}}$$

Odd Metric Pitch Threads on Metric Lead Screw Lathes:

$$\frac{\text{Standard driving gear} \times \text{mm pitch to be cut}}{\text{Standard driven gear} \times \text{gearbox setting in mm pitch}} = \frac{\text{driving gears}}{\text{driven gears}}$$

Finding Accurate Gear Ratios.—Tables included in the 23rd and earlier editions of this handbook furnished a series of logarithms of gear ratios as a quick means of finding ratios for all gear combinations having 15 to 120 teeth. The ratios thus determined could be factored into sets of 2, 4, 6, or any other even numbers of gears to provide a desired overall ratio.

Although the method of using logarithms of gear ratios provides results of suitable accuracy for many gear-ratio problems, it does not provide a systematic means of evaluating whether other, more accurate ratios are available. In critical applications, especially in the design of mechanisms using reduction gear trains, it may be desirable to find many or all possible ratios to meet a specified accuracy requirement. The methods best suited to such problems use *Continued Fractions* and *Conjugate Fractions* as explained starting on pages 11 and illustrated in the worked-out example on page 13 for a set of four change gears.

As an example, if an overall reduction of 0.31416 is required, a fraction must be found such that the factors of the numerator and denominator may be used to form a four-gear reduction train in which no gear has more than 120 teeth. By using the method of conjugate fractions discussed on page 12, the ratios listed above, and their factors are found to be successively closer approximations to the required overall gear ratio.

Ratio	Numerator Factors	Denominator	Error Factors
11/35	11	5 × 7	+0.00013
16/51	2 × 2 × 2 × 2	3 × 17	-0.00043
27/86	3 × 3 × 3	2 × 43	-0.00021
38/121	2 × 19	11 × 11	-0.00011
49/156	7 × 7	2 × 2 × 3 × 13	-0.00006
82/261	2 × 41	3 × 3 × 29	+0.00002
224/713	2 × 2 × 2 × 2 × 2 × 7	23 × 31	+0.000005
437/1391	19 × 23	13 × 107	+0.000002
721/2295	7 × 103	3 × 3 × 3 × 5 × 17	+0.000001
1360/4329	2 × 2 × 2 × 2 × 17	3 × 3 × 13 × 53	+0.0000003
1715/5459	5 × 7 × 7 × 7	53 × 103	+0.0000001
3927/12500	3 × 7 × 11 × 17	2 × 2 × 5 × 5 × 5 × 5 × 5	0

Lathe Change-gears.—To calculate the change gears to cut any pitch on a lathe, the “constant” of the machine must be known. For any lathe, the ratio $C:L$ = driver:driven gear, in which C = constant of machine and L = threads per inch.

For example, to find the change gears required to cut 1.7345 threads per inch on a lathe having a constant of 4, the formula:

$$\frac{C}{L} = \frac{4}{1.7345} = 2.306140$$

may be used. The method of conjugate fractions shown on page 12 will find the ratio, $113/49 = 2.306122$, which is closer than any other having suitable factors. This ratio is in error by only $2.306140 - 2.306122 = 0.000018$. Therefore, the driver should have 113 teeth and the driven gear 49 teeth.

Relieving Helical-Fluted Hobs.—Relieving hobs that have been fluted at right angles to the thread is another example of approximating a required change-gear ratio. The usual method is to change the angle of the helical flutes to agree with previously calculated change-gears. The ratio between the hob and the relieving attachment is expressed in the formula:

$$\frac{N}{(C \times \cos^2 \alpha)} = \frac{\text{driver}}{\text{driven}} \text{ gears}$$

and

$$\tan \alpha = \frac{P}{H_c}$$

in which: N = number of flutes in hob; α = helix angle of thread from plane perpendicular to axis; C = constant of relieving attachment; P = axial lead of hob; and H_c = hob pitch circumference, = 3.1416 times pitch diameter.

The constant of the relieving attachment is found on its index plate and is determined by the number of flutes that require equal gears on the change-gear studs. These values will vary with different makes of lathes.

For example, what four change-gears can be used to relieve a helical-fluted worm-gear hob, of 24 diametral pitch, six starts, 13 degrees, 41 minutes helix angle of thread, with eleven helical flutes, assuming a relieving attachment having a constant of 4 is to be used?

$$\frac{N}{(C \times \cos^2 \alpha)} = \frac{11}{(4 \times \cos^2 13^\circ 41')} = \frac{11}{(4 \times 0.944045)} = 2.913136$$

Using the conjugate fractions method discussed on page 12, the following ratios are found to provide factors that are successively closer approximations to the required change-gear ratio 2.913136.

Numerator/Denominator	Ratio	Error
$67 \times 78 / (39 \times 46)$	2.913043	-0.000093
$30 \times 47 / (22 \times 22)$	2.913223	+0.000087
$80 \times 26 / (21 \times 34)$	2.913165	+0.000029
$27 \times 82 / (20 \times 38)$	2.913158	+0.000021
$55 \times 75 / (24 \times 59)$	2.913136	+0.0000004
$74 \times 92 / (57 \times 41)$	2.913136	+0.00000005

THREAD ROLLING

Screw threads may be formed by rolling either by using some type of thread-rolling machine or by equipping an automatic screw machine or turret lathe with a suitable threading roll. If a thread-rolling machine is used, the unthreaded screw, bolt, or other "blank" is placed (either automatically or by hand) between dies having thread-shaped ridges that sink into the blank, and by displacing the metal, form a thread of the required shape and pitch. The thread-rolling process is applied where bolts, screws, studs, threaded rods, etc., are required in large quantities. Screw threads that are within the range of the rolling process may be produced more rapidly by this method than in any other way. Because of the cold-working action of the dies, the rolled thread is 10 to 20 per cent stronger than a cut or ground thread, and the increase may be much higher for fatigue resistance. Other advantages of the rolling process are that no stock is wasted in forming the thread, and the surface of a rolled thread is harder than that of a cut thread, thus increasing wear resistance.

Thread-Rolling Machine of Flat-Die Type.—One type of machine that is used extensively for thread rolling is equipped with a pair of flat or straight dies. One die is stationary and the other has a reciprocating movement when the machine is in use. The ridges on these dies, which form the screw thread, incline at an angle equal to the helix angle of the thread. In making dies for precision thread rolling, the threads may be formed either by milling and grinding after heat treatment, or by grinding "from the solid" after heat treating. A vitrified wheel is used.

In a thread-rolling machine, thread is formed in one passage of the work, which is inserted at one end of the dies, either by hand or automatically, and then rolls between the die faces until it is ejected at the opposite end. The relation between the position of the dies and a screw thread being rolled is such that the top of the thread-shaped ridge of one die, at the point of contact with the screw thread, is directly opposite the bottom of the thread groove in the other die at the point of contact. Some form of mechanism ensures starting the blank at the right time and square with the dies.

Thread-Rolling Machine of Cylindrical-Die Type.—With machines of this type, the blank is threaded while being rolled between two or three cylindrical dies (depending upon the type of machine) that are pressed into the blank at a rate of penetration adjusted to the hardness of the material, or wall thickness in threading operations on tubing or hollow parts. The dies have ground, or ground and lapped, threads and a pitch diameter that is a multiple of the pitch diameter of the thread to be rolled. As the dies are much larger in diameter than the work, a multiple thread is required to obtain the same lead angle as that of the work. The thread may be formed in one die revolution or even less, or several revolutions may be required (as in rolling hard materials) to obtain a gradual rate of penetration equivalent to that obtained with flat or straight dies if extended to a length of possibly 15 or 20 feet. Provisions for accurately adjusting or matching the thread rolls to bring them into proper alignment with each other are important features of these machines.

Two-Roll Type of Machine: With a two-roll type of machine, the work is rotated between two horizontal power-driven threading rolls and is supported by a hardened rest bar on the lower side. One roll is fed inward by hydraulic pressure to a depth that is governed automatically.

Three-Roll Type of Machine: With this machine, the blank to be threaded is held in a "floating position" while being rolled between three cylindrical dies that, through toggle arms, are moved inward at a predetermined rate of penetration until the required pitch diameter is obtained. The die movement is governed by a cam driven through change gears selected to give the required cycle of squeeze, dwell, and release.

Rate of Production.—Production rates in thread rolling depend upon the type of machine, the size of both machine and work, and whether the parts to be threaded are inserted by hand or automatically. A reciprocating flat die type of machine, applied to ordinary steels, may thread 30 or 40 parts per minute in diameters ranging from about $\frac{5}{8}$ to $1\frac{1}{8}$

inch, and 150 to 175 per minute in machine screw sizes from No. 10 (.190) to No. 6 (.138). In the case of heat-treated alloy steels in the usual hardness range of 26 to 32 Rockwell C, the production may be 30 or 40 per minute or less. With a cylindrical die type of machine, which is designed primarily for precision work and hard metals, 10 to 30 parts per minute are common production rates, the amount depending upon the hardness of material and allowable rate of die penetration per work revolution. These production rates are intended as a general guide only. The diameters of rolled threads usually range from the smallest machine screw sizes up to 1 or 1½ inches, depending upon the type and size of machine.

Precision Thread Rolling.—Both flat and cylindrical dies are used in aeronautical and other plants for precision work. With accurate dies and blank diameters held to close limits, it is practicable to produce rolled threads for American Standard Class 3 and Class 4 fits. The blank sizing may be by centerless grinding or by means of a die in conjunction with the heading operations. The blank should be round, and, as a general rule, the diameter tolerance should not exceed ½ to ⅔ the pitch diameter tolerance. The blank diameter should range from the correct size (which is close to the pitch diameter, but should be determined by actual trial), down to the allowable minimum, the tolerance being minus to insure a correct pitch diameter, even though the major diameter may vary slightly. Precision thread rolling has become an important method of threading alloy steel studs and other threaded parts, especially in aeronautical work where precision and high-fatigue resistance are required. Micrometer screws are also an outstanding example of precision thread rolling. This process has also been applied in tap making, although it is the general practice to finish rolled taps by grinding when the Class 3 and Class 4 fits are required.

Steels for Thread Rolling.—Steels vary from soft low-carbon types for ordinary screws and bolts, to nickel, nickel-chromium and molybdenum steels for aircraft studs, bolts, etc., or for any work requiring exceptional strength and fatigue resistance. Typical SAE alloy steels are No. 2330, 3135, 3140, 4027, 4042, 4640 and 6160. The hardness of these steels after heat-treatment usually ranges from 26 to 32 Rockwell C, with tensile strengths varying from 130,000 to 150,000 pounds per square inch. While harder materials might be rolled, grinding is more practicable when the hardness exceeds 40 Rockwell C. Thread rolling is applicable not only to a wide range of steels but for non-ferrous materials, especially if there is difficulty in cutting due to "tearing" the threads.

Diameter of Blank for Thread Rolling.—The diameter of the screw blank or cylindrical part upon which a thread is to be rolled should be less than the outside screw diameter by an amount that will just compensate for the metal that is displaced and raised above the original surface by the rolling process. The increase in diameter is approximately equal to the depth of one thread. While there are rules and formulas for determining blank diameters, it may be necessary to make slight changes in the calculated size in order to secure a well-formed thread. The blank diameter should be verified by trial, especially when rolling accurate screw threads. Some stock offers greater resistance to displacement than other stock, owing to the greater hardness or tenacity of the metal. The following figures may prove useful in establishing trial sizes. The blank diameters for screws varying from ¼ to ½ are from 0.002 to 0.0025 inch larger than the pitch diameter, and for screws varying from ½ to 1 inch or larger, the blank diameters are from 0.0025 to .003 inch larger than the pitch diameter. Blanks which are slightly less than the pitch diameter are intended for bolts, screws, etc., which are to have a comparatively free fit. Blanks for this class of work may vary from 0.002 to 0.003 inch less than the pitch diameter for screw thread sizes varying from ¼ to ½ inch, and from 0.003 to 0.005 inch less than the pitch diameter for sizes above ½ inch. If the screw threads are smaller than ¼ inch, the blanks are usually from 0.001 to 0.0015 inch less than the pitch diameter for ordinary grades of work.

Thread Rolling in Automatic Screw Machines.—Screw threads are sometimes rolled in automatic screw machines and turret lathes when the thread is behind a shoulder so that

it cannot be cut with a die. In such cases, the advantage of rolling the thread is that a second operation is avoided. A circular roll is used for rolling threads in screw machines. The roll may be presented to the work either in a tangential direction or radially, either method producing a satisfactory thread. In the former case, the roll gradually comes into contact with the periphery of the work and completes the thread as it passes across the surface to be threaded. When the roll is held in a radial position, it is simply forced against one side until a complete thread is formed. The method of applying the roll may depend upon the relation between the threading operation and other machining operations. Thread rolling in automatic screw machines is generally applied only to brass and other relatively soft metals, owing to the difficulty of rolling threads in steel. Thread rolls made of chrome-nickel steel containing from 0.15 to 0.20 per cent of carbon have given fairly good results, however, when applied to steel. A 3 per cent nickel steel containing about 0.12 per cent carbon has also proved satisfactory for threading brass.

Factors Governing the Diameter of Thread Rolling.—The threading roll used in screw machines may be about the same diameter as the screw thread, but for sizes smaller than, say, $\frac{3}{4}$ inch, the roll diameter is some multiple of the thread diameter minus a slight amount to obtain a better rolling action. When the diameters of the thread and roll are practically the same, a single-threaded roll is used to form a single thread on the screw. If the diameter of the roll is made double that of the screw, in order to avoid using a small roll, then the roll must have a double thread. If the thread roll is three times the size of the screw thread, a triple thread is used, and so on. These multiple threads are necessary when the roll diameter is some multiple of the work, in order to obtain corresponding helix angles on the roll and work.

Diameter of Threading Roll.—The pitch diameter of a threading roll having a single thread is slightly less than the pitch diameter of the screw thread to be rolled, and in the case of multiple-thread rolls, the pitch diameter is not an exact multiple of the screw thread pitch diameter but is also reduced somewhat. The amount of reduction recommended by one screw machine manufacturer is given by the formula shown at the end of this paragraph. A description of the terms used in the formula is given as follows: D = pitch diameter of threading roll, d = pitch diameter of screw thread, N = number of single threads or "starts" on the roll (this number is selected with reference to diameter of roll desired), T = single depth of thread:

$$D = N\left(d - \frac{T}{2}\right) - T$$

Example: Find, by using above formula, the pitch diameter of a double-thread roll for rolling a $\frac{1}{2}$ -inch American standard screw thread. Pitch diameter $d = 0.4500$ inch and thread depth $T = 0.0499$ inch.

$$D = 2\left(0.4500 - \frac{0.0499}{2}\right) - 0.0499 = 0.8001 \text{ inch}$$

Kind of Thread on Roll and Its Shape.—The thread (or threads) on the roll should be left hand for rolling a right-hand thread, and *vice versa*. The roll should be wide enough to overlap the part to be threaded, provided there are clearance spaces at the ends, which should be formed if possible. The thread on the roll should be sharp on top for rolling an American (National) standard form of thread, so that less pressure will be required to displace the metal when rolling the thread. The bottom of the thread groove on the roll may also be left sharp or it may have a flat. If the bottom is sharp, the roll is sunk only far enough into the blank to form a thread having a flat top, assuming that the thread is the American form. The number of threads on the roll (whether double, triple, quadruple, etc.) is selected, as a rule, so that the diameter of the thread roll will be somewhere between $1\frac{1}{4}$ and $2\frac{1}{4}$ inches. In making a thread roll, the ends are beveled at an angle of 45 degrees, to prevent

the threads on the ends of the roll from chipping. Precautions should be taken in hardening, because, if the sharp edges are burnt, the roll will be useless. Thread rolls are usually lapped after hardening, by holding them on an arbor in the lathe and using emery and oil on a piece of hard wood. To give good results a thread roll should fit closely in the holder. If the roll is made to fit loosely, it will mar the threads.

Application of Thread Roll.—The shape of the work and the character of the operations necessary to produce it, govern, to a large extent, the method employed in applying the thread roll. Some of the points to consider are as follows:

- 1) Diameter of the part to be threaded.
- 2) Location of the part to be threaded.
- 3) Length of the part to be threaded.
- 4) Relation that the thread rolling operation bears to the other operations.
- 5) Shape of the part to be threaded, whether straight, tapered or otherwise.
- 6) Method of applying the support.

When the diameter to be rolled is much smaller than the diameter of the shoulder preceding it, a cross-slide knurl-holder should be used. If the part to be threaded is not behind a shoulder, a holder on the swing principle should be used. When the work is long (greater in length than two-and-one-half times its diameter) a swing roll-holder should be employed, carrying a support. When the work can be cut off after the thread is rolled, a cross-slide roll-holder should be used. The method of applying the support to the work also governs to some extent the method of applying the thread roll. When no other tool is working at the same time as the thread roll, and when there is freedom from chips, the roll can be held more rigidly by passing it under instead of over the work. When passing the roll over the work, there is a tendency to raise the cross-slide. Where the part to be threaded is tapered, the roll can best be presented to the work by holding it in a cross-slide roll-holder.

Tolerances on Wire for Thread Rolling.—The wire mills will accept a tolerance specification of plus or minus 0.002 inch on the diameter. It is particularly important that this tolerance be maintained on stock used for long screws of small diameter. On screws of short length the material will flow, and if the wire is over size little trouble will be experienced, but in the case of screws having a length greater than ten times their diameter, the material will be confined, and “burning” will take place, if the tolerance is greater than that specified. If the wire is slightly under size, the rolled threads will have a ragged appearance due to the fact that the crest is not fully formed. On screws under the No. 10-24 size, a tolerance of plus or minus 0.001 inch should be adhered to in order to ensure good results.

Speeds and Feeds for Thread Rolling.—When the thread roll is made from high-carbon steel and used on brass, a surface speed as high as 200 feet per minute can be used. However, better results are obtained by using a lower speed than this. When the roll is held in a holder attached to the cross-slide, and is presented either tangentially or radially to the work, a considerably higher speed can be used than if it is held in a swing tool. This is due to the lack of rigidity in a holder of the swing type. The feeds to be used when a cross-slide roll-holder is used are given in the upper half of the table “Feeds for Thread Rolling;” the lower half of the table gives the feeds for thread rolling with swing tools. These feeds are applicable for rolling threads without a support, when the root diameter of the blank is not less than five times the double depth of the thread. When the root diameter is less than this, a support should be used. A support should also be used when the width of the roll is more than two-and-one-half times the smallest diameter of the piece to be rolled, irrespective of the pitch of the thread. When the smallest diameter of the piece to be rolled is much less than the root diameter of the thread, the smallest diameter should be taken as the deciding factor for the feed to be used.

Feeds for Thread Rolling

Root Diam. of Blank	Number of Threads per Inch													
	72	64	56	48	44	40	36	32	28	24	22	20	18	14
	Cross-slide Holders — Feed per Revolution in Inches													
$\frac{1}{8}$	0.0045	0.0040	0.0035	0.0030	0.0025	0.0020	0.0015	0.0010
$\frac{3}{16}$	0.0050	0.0045	0.0040	0.0035	0.0030	0.0025	0.0020	0.0015	0.0005
$\frac{1}{4}$	0.0055	0.0050	0.0045	0.0040	0.0035	0.0030	0.0025	0.0020	0.0010	0.0005	0.0005
$\frac{5}{16}$	0.0060	0.0055	0.0050	0.0045	0.0040	0.0035	0.0030	0.0025	0.0015	0.0010	0.0010	0.0005	0.0005
$\frac{3}{8}$	0.0065	0.0060	0.0055	0.0050	0.0045	0.0040	0.0035	0.0030	0.0020	0.0015	0.0015	0.0010	0.0010	0.0005
$\frac{7}{16}$	0.0070	0.0065	0.0060	0.0055	0.0050	0.0045	0.0040	0.0035	0.0025	0.0020	0.0020	0.0015	0.0015	0.0010
$\frac{1}{2}$	0.0075	0.0070	0.0065	0.0060	0.0055	0.0050	0.0045	0.0040	0.0030	0.0025	0.0025	0.0020	0.0020	0.0015
$\frac{5}{8}$	0.0080	0.0075	0.0070	0.0065	0.0060	0.0055	0.0050	0.0045	0.0035	0.0030	0.0030	0.0025	0.0025	0.0020
$\frac{3}{4}$	0.0085	0.0080	0.0075	0.0070	0.0065	0.0060	0.0055	0.0050	0.0040	0.0035	0.0035	0.0030	0.0030	0.0025
$\frac{7}{8}$	0.0090	0.0085	0.0080	0.0075	0.0070	0.0065	0.0060	0.0055	0.0045	0.0040	0.0040	0.0035	0.0035	0.0030
1	0.0095	0.0090	0.0085	0.0080	0.0075	0.0070	0.0065	0.0060	0.0050	0.0045	0.0045	0.0040	0.0040	0.0035
Root Diam.	Swing Holders — Feed per Revolution in Inches													
$\frac{1}{8}$	0.0025	0.0020	0.0015	0.0010	0.0005
$\frac{3}{16}$	0.0028	0.0025	0.0020	0.0015	0.0008	0.0005
$\frac{1}{4}$	0.0030	0.0030	0.0025	0.0020	0.0010	0.0010	0.0005	0.0005	0.0005
$\frac{5}{16}$	0.0035	0.0035	0.0030	0.0025	0.0015	0.0015	0.0010	0.0010	0.0010	0.0005
$\frac{3}{8}$	0.0040	0.0040	0.0035	0.0030	0.0020	0.0020	0.0015	0.0015	0.0015	0.0010	0.0005	0.0005	0.0005
$\frac{7}{16}$	0.0045	0.0045	0.0040	0.0035	0.0030	0.0025	0.0020	0.0020	0.0020	0.0015	0.0010	0.0010	0.0010
$\frac{1}{2}$	0.0048	0.0048	0.0045	0.0040	0.0035	0.0030	0.0025	0.0025	0.0025	0.0020	0.0015	0.0015	0.0015	0.0005
$\frac{5}{8}$	0.0050	0.0050	0.0048	0.0043	0.0040	0.0035	0.0030	0.0030	0.0028	0.0025	0.0020	0.0020	0.0018	0.0010
$\frac{3}{4}$	0.0055	0.0052	0.0050	0.0045	0.0043	0.0040	0.0035	0.0035	0.0030	0.0028	0.0025	0.0022	0.0020	0.0013
$\frac{7}{8}$	0.0058	0.0055	0.0052	0.0048	0.0045	0.0043	0.0040	0.0038	0.0032	0.0030	0.0028	0.0025	0.0022	0.0015
1	0.0060	0.0058	0.0054	0.0050	0.0048	0.0047	0.0043	0.0040	0.0035	0.0032	0.0030	0.0028	0.0025	0.0018

THREAD ROLLING

1957

THREAD GRINDING

Thread grinding is employed for precision tool and gage work and also in producing certain classes of threaded parts.

Thread grinding may be utilized 1) because of the accuracy and finish obtained; 2) hardness of material to be threaded; and 3) economy in grinding certain classes of screw threads when using modern machines, wheels, and thread-grinding oils.

In some cases pre-cut threads are finished by grinding; but usually, threads are ground "from the solid," being formed entirely by the grinding process. Examples of work include thread gages and taps of steel and tungsten carbide, hobs, worms, lead-screws, adjusting or traversing screws, alloy steel studs, etc. Grinding is applied to external, internal, straight, and tapering threads, and to various thread forms.

Accuracy Obtainable by Thread Grinding.—With single-edge or single-ribbed wheels it is possible to grind threads on gages to a degree of accuracy that requires but very little lapping to produce a so-called "master" thread gage. As far as lead is concerned, some thread grinding machine manufacturers guarantee to hold the lead within 0.0001 inch per inch of thread; and while it is not guaranteed that a higher degree of accuracy for lead is obtainable, it is known that threads have been ground to closer tolerances than this on the lead. Pitch diameter accuracies for either Class 3 or Class 4 fits are obtainable according to the grinding method used; with single-edge wheels, the thread angle can be ground to an accuracy of within two or three minutes in half the angle.

Wheels for Thread Grinding.—The wheels used for steel have an aluminous abrasive and, ordinarily, either a resinoid bond or a vitrified bond. The general rule is to use resinoid wheels when extreme tolerances are not required, and it is desirable to form the thread with a minimum number of passes, as in grinding threaded machine parts, such as studs, adjusting screws which are not calibrated, and for some classes of taps. *Resinoid wheels*, as a rule, will hold a fine edge longer than a vitrified wheel but they are more flexible and, consequently, less suitable for accurate work, especially when there is lateral grinding pressure that causes wheel deflection. *Vitrified wheels* are utilized for obtaining extreme accuracy in thread form and lead because they are very rigid and not easily deflected by side pressure in grinding. This rigidity is especially important in grinding pre-cut threads on such work as gages, taps and lead-screws. The progressive lead errors in long lead-screws, for example, might cause an increasing lateral pressure that would deflect a resinoid wheel. Vitrified wheels are also recommended for internal grinding.

Diamond Wheels: Diamond wheels set in a rubber or plastic bond are also used for thread grinding, especially for grinding threads in carbide materials and in other hardened alloys. Thread grinding is now being done successfully on a commercial basis on both taps and gages made from carbides. Gear hobs made from carbides have also been tested with successful results. Diamond wheels are dressed by means of silicon-carbide grinding wheels which travel past the diamond-wheel thread form at the angle required for the flanks of the thread to be ground. The action of the dressing wheels is, perhaps, best described as a "scrubbing" of the bond which holds the diamond grits. Obviously, the silicon-carbide wheels do not dress the diamonds, but they loosen the bond until the diamonds not wanted drop out.

Thread Grinding with Single-Edge Wheel.—With this type of wheel, the edge is tried to the cross-sectional shape of the thread groove. The wheel, when new, may have a diameter of 18 or 20 inches and, when grinding a thread, the wheel is inclined to align it with the thread groove. On some machines, lead variations are obtained by means of change-gears which transmit motion from the work-driving spindle to the lead-screw. Other machines are so designed that a lead-screw is selected to suit the lead of thread to be ground and transmits motion directly to the work-driving spindle.

Wheels with Edges for Roughing and Finishing.—The “three-ribbed” type of wheel has a roughing edge or rib which removes about two-thirds of the metal. This is followed by an intermediate rib which leaves about 0.005 inch for the third or finishing rib. The accuracy obtained with this triple-edge type compares with that of a single-edge wheel, which means that it may be used for the greatest accuracy obtainable in thread grinding.

When the accuracy required makes it necessary, this wheel can be inclined to the helix angle of the thread, the same as is the single-edge wheel.

The three-ribbed wheel is recommended not only for precision work but for grinding threads which are too long for the multi-ribbed wheel referred to later. It is also well adapted to tap grinding, because it is possible to dress a portion of the wheel adjacent to the finish rib for the purpose of grinding the outside diameter of the thread, as indicated in Fig. 1. Furthermore, the wheel can be dressed for grinding or relieving both crests and flanks at the same time.

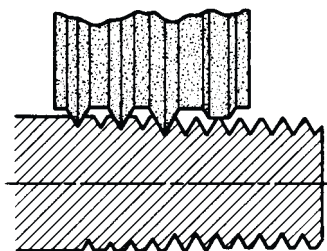

Fig. 1. Wheel with Edges for Roughing and Finishing

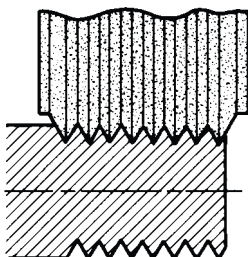

Fig. 2. Multi-ribbed Type of Thread-grinding Wheel

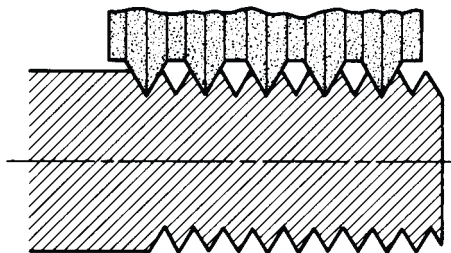

Fig. 3. Alternate-ribbed Wheel for Grinding the Finer Pitches

Multi-ribbed Wheels.—This type of wheel is employed when rapid production is more important than extreme accuracy, which means that it is intended primarily for the grinding of duplicate parts in manufacturing. A wheel $1\frac{1}{4}$ to 2 inches wide has formed upon its face a series of annular thread-shaped ridges (see Fig. 2); hence, if the length of the thread is not greater than the wheel width, a thread may be ground in one work revolution plus about one-half revolution for feeding in and withdrawing the wheel. The principle of operation is the same as that of thread milling with a multiple type cutter. This type of wheel is not inclined to the lead angle. To obtain a Class 3 fit, the lead angle should not exceed 4 degrees.

It is not practicable to use this form of wheel on thread pitches where the root is less than 0.007 inch wide, because of difficulties in wheel dressing. When this method can be applied, it is the fastest means known of producing threads in hardened materials. It is not recommended, however, that thread gages, taps, and work of this character be ground with multi-ribbed wheels. The single-ribbed wheel has a definite field for accurate, small-lot production.

It is necessary, in multi-ribbed grinding, to use more horsepower than is required for single-ribbed wheel grinding. Coarse threads, in particular, may require a wheel motor with two or three times more horsepower than would be necessary for grinding with a single-ribbed wheel.

Alternate-ribbed Wheel for Fine Pitches.—The spacing of ribs on this type of wheel (Fig. 3) equals twice the pitch, so that during the first revolution every other thread groove section is being ground; consequently, about two and one-half work revolutions are required for grinding a complete thread, but the better distribution of cooling oil and resulting increase in work speeds makes this wheel very efficient. This alternate-type of wheel is adapted for grinding threads of fine pitch. Since these wheels cannot be tipped to the helix angle of the thread, they are not recommended for anything closer than Class 3 fits. The “three-ribbed” wheels referred to in a previous paragraph are also made in the alternate type for the finer pitches.

Grinding Threads “from the Solid”.—The process of forming threads entirely by grinding, or without preliminary cutting, is applied both in the manufacture of certain classes of threaded parts and also in the production of precision tools, such as taps and thread gages. For example, in airplane engine manufacture, certain parts are heat-treated and then the threads are ground “from the solid,” thus eliminating distortion. Minute cracks are sometimes found at the roots of threads that were cut and then hardened, or ground from the solid. Steel threads of coarse pitch that are to be surface hardened, may be rough threaded by cutting, then hardened and finally corrected by grinding. Many ground thread taps are produced by grinding from the solid after heat-treatment. Hardening high-speed steel taps before the thread is formed will make sure there are no narrow or delicate crests to interfere with the application of the high temperature required for uniform hardness and the best steel structure.

Number of Wheel Passes.—The number of cuts or passes for grinding from the solid depends upon the type of wheel and accuracy required. In general, threads of 12 or 14 per inch and finer may be ground in one pass of a single-edge wheel unless the “unwrapped” thread length is much greater than normal. Unwrapped length = pitch circumference \times total number of thread turns, approximately. For example, a thread gage $1\frac{1}{4}$ inches long with 24 threads per inch would have an unwrapped length equal to $30 \times$ pitch circumference. (If more convenient, outside circumference may be used instead of pitch circumference.) Assume that there are 6 or 7 feet of unwrapped length on a screw thread having 12 threads per inch. In this case, one pass might be sufficient for a Class 3 fit, whereas two passes might be recommended for a Class 4 fit. When two passes are required, too deep a roughing cut may break down the narrow edge of the wheel. To prevent this, try a roughing cut depth equal to about two-thirds the total thread depth, thus leaving one-third for the finishing cut.

Wheel and Work Rotation.—When a screw thread, on the side being ground, is moving *upward* or *against* the grinding wheel rotation, less heat is generated and the grinding operation is more efficient than when wheel and work are moving in the same direction on the grinding side; however, to avoid running a machine idle during its return stroke, many screw threads are ground during both the forward and return traversing movements, by reversing the work rotation at the end of the forward stroke. For this reason, thread grinders generally are equipped so that both forward and return work speeds may be changed; they may also be designed to accelerate the return movement when grinding in one direction only.

Wheel Speeds.—Wheel speeds should always be limited to the maximum specified on the wheel by the manufacturer. According to the American National Standard Safety Code, resinoid and vitrified wheels are limited to 12,000 surface feet per minute; however, according to Norton Co., the most efficient speeds are from 9,000 to 10,000 for resinoid wheels and 7,500 to 9,500 for vitrified wheels. Only tested wheels recommended by the wheel manufacturer should be used. After a suitable surface speed has been established, it should be maintained by increasing the rpm of the wheel, as the latter is reduced in diameter by wear.

Since thread grinding wheels work close to the limit of their stock-removing capacity, some adjustment of the wheel or work speed may be required to get the best results. If the wheel speed is too slow for a given job and excessive heat is generated, try an increase in speed, assuming that such increase is within the safety limits. If the wheel is too soft and the edge wears excessively, again an increase in wheel speed will give the effect of a harder wheel and result in better form-retaining qualities.

Work Speeds.—The work speed usually ranges from 3 to 10 feet per minute. In grinding with a comparatively heavy feed, and a minimum number of passes, the speed may not exceed $2\frac{1}{2}$ or 3 feet per minute. If very light feeds are employed, as in grinding hardened high-speed steel, the work speed may be much higher than 3 feet per minute and should be determined by test. If excessive heat is generated by removing stock too rapidly, a work speed reduction is one remedy. If a wheel is working below its normal capacity, an increase in work speed would prevent dulling of the grains and reduce the tendency to heat or "burn" the work. An increase in work speed and reduction in feed may also be employed to prevent burning while grinding hardened steel.

Truing Grinding Wheels.—Thread grinding wheels are trued both to maintain the required thread form and also an efficient grinding surface. Thread grinders ordinarily are equipped with precision truing devices which function automatically. One type automatically dresses the wheel and also compensates for the slight amount removed in dressing, thus automatically maintaining size control of the work. While truing the wheel, a small amount of grinding oil should be used to reduce diamond wear. Light truing cuts are advisable, especially in truing resinoid wheels which may be deflected by excessive truing pressure. A master former for controlling the path followed by the truing diamond may require a modified profile to prevent distortion of the thread form, especially when the lead angles are comparatively large. Such modification usually is not required for 60-degree threads when the pitches for a given diameter are standard because then the resulting lead angles are less than $4\frac{1}{2}$ degrees. In grinding Acme threads or 29-degree worm threads having lead angles greater than 4 or 5 degrees, modified formers may be required to prevent a bulge in the thread profile. The highest point of this bulge is approximately at the pitch line. A bulge of about 0.001 inch may be within allowable limits on some commercial worms but precision worms for gear hobbers, etc., require straight flanks in the axial plane.

Crushing Method: Thread grinding wheels are also dressed or formed by the crushing method, which is used in connection with some types of thread grinding machines. When this method is used, the annular ridge or ridges on the wheel are formed by a hardened steel cylindrical dresser or crusher. The crusher has a series of smooth annular ridges which are shaped and spaced like the thread that is to be ground. During the wheel dressing operation, the crusher is positively driven instead of the grinding wheel, and the ridges on the wheel face are formed by the rotating crusher being forced inward.

Wheel Hardness or Grade.—Wheel hardness or grade selection is based upon a compromise between efficient cutting and durability of the grinding edge. Grade selection depends on the bond and the character of the work. The following general recommendations are based upon Norton grading.

Vitrified wheels usually range from J to M, and resinoid wheels from R to U. For heat-treated screws or studs and the Unified Standard Thread, try the following. For 8 to 12

threads per inch, grade S resinoid wheel; for 14 to 20 threads per inch, grade T resinoid; for 24 threads per inch and finer, grades T or U resinoid. For high-speed steel taps 4 to 12 threads per inch, grade J vitrified or S resinoid; 14 to 20 threads per inch, grade K vitrified or T resinoid; 24 to 36 threads per inch, grade M vitrified or T resinoid.

Grain Size.—A thread grinding wheel usually operates close to its maximum stock-removing capacity, and the narrow edge which forms the root of the thread is the most vulnerable part. In grain selection, the general rule is to use the coarsest grained wheel that will hold its form while grinding a reasonable amount of work. Pitch of thread and quality of finish are two governing factors. Thus, to obtain an exceptionally fine finish, the grain size might be smaller than is needed to retain the edge profile. The usual grain sizes range from 120 to 150. For heat-treated screws and studs with Unified Standard Threads, 100 to 180 is the usual range. For precision screw threads of very fine pitch, the grain size may range from 220 to 320. For high-speed steel taps, the usual range is from 150 to 180 for Unified Standard Threads, and from 80 to 150 for pre-cut Acme threads.

Thread Grinding by Centerless Method.—Screw threads may be ground from the solid by the centerless method. A centerless thread grinder is similar in its operating principle to a centerless grinder designed for general work, in that it has a grinding wheel, a regulating or feed wheel (with speed adjustments), and a work-rest. Adjustments are provided to accommodate work of different sizes and for varying the rates of feed. The grinding wheel is a multi-ribbed type, being a series of annular ridges across the face. These ridges conform in pitch and profile with the thread to be ground. The grinding wheel is inclined to suit the helix or lead angle of the thread. In grinding threads on such work as socket type set-screws, the blanks are fed automatically and passed between the grinding and regulating wheels in a continuous stream. To illustrate production possibilities, hardened socket set-screws of $\frac{1}{4}$ -20 size may be ground from the solid at the rate of 60 to 70 per minute and with the wheel operating continuously for 8 hours without redressing. The lead errors of centerless ground screw threads may be limited to 0.0005 inch per inch or even less by reducing the production rate. The pitch diameter tolerances are within 0.0002 to 0.0003 inch of the basic size. The grain size for the wheel is selected with reference to the pitch of the thread, the following sizes being recommended: For 11 to 13 threads per inch, 150; for 16 threads per inch, 180; for 18 to 20 threads per inch, 220; for 24 to 28 threads per inch, 320; for 40 threads per inch, 400.

Principle of Centerless Grinding.—Centerless grinding is the grinding of cylindrical work without supporting it on centers in the usual way. Two abrasive wheels are mounted so that their peripheries face each other, one of the wheels having its axis so arranged that it can be swung out of parallel with the axis of the other wheel by varying amounts, as required. Between these two abrasive wheels is a work-supporting member equipped with suitable guides. The grinding wheel forces the work downward against the work-rest and also against the regulating wheel. The latter imparts a uniform rotation to the work which has the same peripheral speed as the regulating wheel, the speed of which is adjustable.

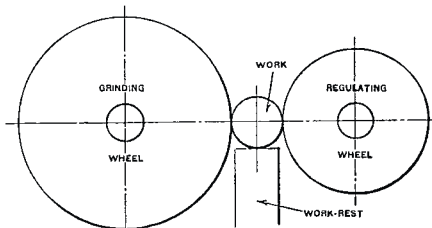

Principle of the Centerless Grinding Process

THREAD MILLING

Single-cutter Method.—Usually, when a single point cutter is used, the axis of the cutter is inclined an amount equal to the lead angle of the screw thread, in order to locate the cutter in line with the thread groove at the point where the cutting action takes place. Tangent of lead angle = lead of screw thread ÷ pitch circumference of screw.

The helical thread groove is generated by making as many turns around the workpiece diameter as there are pitches in the length of thread to be cut. For example, a 16-pitch thread, 1 inch long, would require 16 turns of the cutter around the work. The single cutter process is especially applicable to the milling of large screw threads of coarse pitch, and either single or multiple threads.

The cutter should revolve as fast as possible without dulling the cutting edges excessively, in order to mill a smooth thread and prevent the unevenness that would result with a slow-moving cutter, on account of the tooth spaces. As the cutter rotates, the part on which a thread is to be milled is also revolved, but at a very slow rate (a few inches per minute), since this rotation of the work is practically a feeding movement. The cutter is ordinarily set to the full depth of the thread groove and finishes a single thread in one passage, although deep threads of coarse pitch may require two or even three cuts. For fine pitches and short threads, the multiple-cutter method (described in the next paragraph) usually is preferable, because it is more rapid. The milling of taper screw threads may be done on a single-cutter type of machine by traversing the cutter laterally as it feeds along in a lengthwise direction, the same as when using a taper attachment on a lathe.

Multiple-cutter Method.—The multiple cutter for thread milling is practically a series of single cutters, although formed of one solid piece of steel, at least so far as the cutter proper is concerned. The rows of teeth do not lie in a helical path, like the teeth of a hob or tap, but they are annular or without lead. If the cutter had helical teeth the same as a gear hob, it would have to be geared to revolve in a certain fixed ratio with the screw being milled, but a cutter having annular teeth may rotate at any desired cutting speed, while the screw blank is rotated slowly to provide a suitable rate of feed. (The multiple thread milling cutters used are frequently called "hobs," but the term hob should be applied only to cutters having a helical row of teeth like a gear-cutting hob.)

The object in using a multiple cutter instead of a single cutter is to finish a screw thread complete in approximately one revolution of the work, a slight amount of over-travel being allowed to insure milling the thread to the full depth where the end of cut joins the starting point. The cutter which is at least one and one half or two threads or pitches wider than the thread to be milled, is fed in to the full thread depth and then either the cutter or screw blank is moved in a lengthwise direction a distance equal to the lead of the thread during one revolution of the work.

The multiple cutter is used for milling comparatively short threads and coarse, medium or fine pitches. The accompanying illustration shows typical examples of external and internal work for which the multiple-cutter type of thread milling has proved very efficient, although its usefulness is not confined to shoulder work and "blind" holes.

In using multiple cutters either for internal or external thread milling, the axis of the cutter is set parallel with the axis of the work, instead of inclining the cutter to suit the lead angle of the thread, as when using a single cutter. Theoretically, this is not the correct position for a cutter, since each cutting edge is revolving in a plane at right angles to the screw's axis while milling a thread groove of helical form. However, as a general rule, interference between the cutter and the thread, does not result a decided change in the standard thread form. Usually the deviation is very slight and may be disregarded except when milling threads which incline considerably relative to the axis like a thread of multiple form and large lead angle. Multiple cutters are suitable for external threads having lead angles under $3\frac{1}{2}$ degrees and for internal threads having lead angles under $2\frac{1}{2}$ degrees. Threads which have steeper sides or smaller included angles than the American Standard or Whitworth

forms have greater limitations on the maximum helix angle and may have to be milled with a single point cutter tilted to the helix angle, assuming that the milling process is preferable to other methods. For instance, in milling an Acme thread which has an included angle between the sides of 29 degrees, there might be considerable interference if a multiple cutter were used, unless the screw thread diameter were large enough in proportion to the pitch to prevent such interference. If an attempt were made to mill a square thread with a multiple cutter, the results would be unsatisfactory owing to the interference.

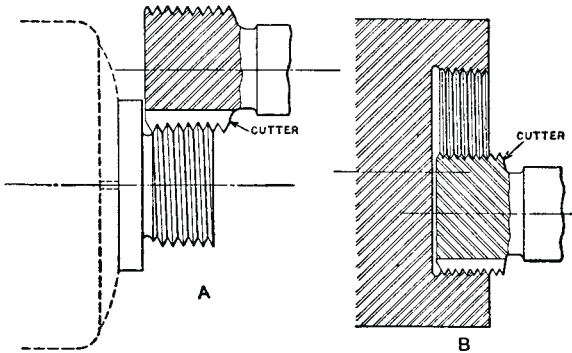

Examples of External and Internal Thread Milling
with a Multiple Thread Milling Cutter

Interference between the cutter and work is more pronounced when milling internal threads, because the cutter does not clear itself so well. It is preferable to use as small a cutter as practicable, either for internal or external work, not only to avoid interference, but to reduce the strain on the driving mechanism. Some thread milling cutters, known as "topping cutters," are made for milling the outside diameter of the thread as well as the angular sides and root, but most are made non-tapping.

Planetary Method.—The planetary method of thread milling is similar in principle to planetary milling. The part to be threaded is held stationary and the thread milling cutter, while revolving about its own axis, is given a planetary movement around the work in order to mill the thread in one planetary revolution. The machine spindle and the cutter which is held by it is moved longitudinally for thread milling, an amount equal to the thread lead during one planetary revolution. This operation is applicable to both internal and external threads. Other advantages: Thread milling is frequently accompanied by milling operations on other adjoining surfaces, and may be performed with conventional and planetary methods. For example, a machine may be used for milling a screw thread and a concentric cylindrical surface simultaneously. When the milling operation begins, the cutter-spindle feeds the cutter in to the right depth and the planetary movement then begins, thus milling the thread and the cylindrical surface. Thin sharp starting edges are eliminated on threads milled by this method and the thread begins with a smooth gradual approach. One design of machine will mill internal and external threads simultaneously. These threads may be of the same hand or one may be right hand and the other left hand. The threads may also be either of the same pitch or of a different pitch, and either straight or tapered.

Classes of Work for Thread Milling Machines.—Thread milling machines are used in preference to lathes or taps and dies for certain threading operations.

There are four general reasons why a thread milling machine may be preferred:

- 1) Because the pitch of the thread is too coarse for cutting with a die; 2) because the milling process is more efficient than using a single-point tool in a lathe; 3) to secure a smoother and more accurate thread than would be obtained with a tap or die; and
- 4) because the thread is so located relative to a shoulder or other surface that the milling method is superior, if not the only practicable way.

A thread milling machine having a single cutter is especially adapted for coarse pitches, multiple-threaded screws, or any form or size of thread requiring the removal of a relatively large amount of metal, particularly if the pitch of the thread is large in proportion to the screw diameter, since the torsional strain due to the milling process is relatively small. Thread milling often gives a higher rate of production, and a thread is usually finished by means of a single turn of the multiple thread milling cutter around the thread diameter. The multiple-cutter type of thread milling machine frequently comes into competition with dies and taps, and especially self-opening dies and collapsing taps. The use of a multiple cutter is desirable when a thread must be cut close to a shoulder or to the bottom of a shallow recess, although the usefulness of the multiple cutter is not confined to shoulder work and "blind" holes.

Maximum Pitches of Die-cut Threads.—Dies of special design could be constructed for practically any pitch, if the screw blank were strong enough to resist the cutting strains and the size and cost of the die were immaterial; but, as a general rule, when the pitch is coarser than four or five threads per inch, the difficulty of cutting threads with dies increases rapidly, although in a few cases some dies are used successfully on screw threads having two or three threads per inch or less. Much depends upon the design of the die, the finish or smoothness required, and the relation between the pitch of the thread and the diameter of the screw. When the screw diameter is relatively small in proportion to the pitch, there may be considerable distortion due to the twisting strains set up when the thread is being cut. If the number of threads per inch is only one or two less than the standard number for a given diameter, a screw blank ordinarily will be strong enough to permit the use of a die.

Changing Pitch of Screw Thread Slightly.—A very slight change in the pitch of a screw thread may be necessary as, for example, when the pitch of a tap is increased a small amount to compensate for shrinkage in hardening. One method of obtaining slight variations in pitch is by means of a taper attachment. This attachment is set at an angle and the work is located at the same angle by adjusting the tailstock center. The result is that the tool follows an angular path relative to the movement of the carriage and, consequently, the pitch of the thread is increased slightly, the amount depending upon the angle to which the work and taper attachment are set. The cosine of this angle, for obtaining a given increase in pitch, equals the standard pitch (which would be obtained with the lathe used in the regular way) divided by the increased pitch necessary to compensate for shrinkage.

Example: If the pitch of a $\frac{3}{4}$ -inch American standard screw is to be increased from 0.100 to 0.1005, the cosine of the angle to which the taper attachment and work should be set is found as follows:

$$\text{Cosine of required angle} = \frac{0.100}{0.1005} = 0.9950$$

which is the cosine of 5 degrees 45 minutes, nearly.

Change Gears for Helical Milling

Lead of a Milling Machine.—If gears with an equal number of teeth are placed on the table feed-screw and the worm-gear stud, then the *lead of the milling machine* is the distance the table will travel while the index spindle makes one complete revolution. This distance is a constant used in figuring the change gears.

The lead of a helix or "spiral" is the distance, measured along the axis of the work, in which the helix makes one full turn around the work. The lead of the milling machine may, therefore, also be expressed as the lead of the helix that will be cut when gears with an equal number of teeth are placed on the feed-screw and the worm-gear stud, and an idler of suitable size is interposed between the gears.

Rule: To find the lead of a milling machine, place equal gears on the worm-gear stud and on the feed-screw, and multiply the number of revolutions made by the feed-screw to produce one revolution of the index head spindle, by the lead of the thread on the feed-screw. Expressing the rule given as a formula:

$$\text{lead of milling machine} = \frac{\text{rev. of feed-screw for one revolution of index spindle with equal gears}}{\text{lead of feed-screw}}$$

Assume that it is necessary to make 40 revolutions of the feed-screw to turn the index head spindle one complete revolution, when the gears are equal, and that the lead of the thread on the feed-screw of the milling machine is $\frac{1}{4}$ inch; then the lead of the machine equals $40 \times \frac{1}{4}$ inch = 10 inches.

Change Gears for Helical Milling.—To find the change gears to be used in the compound train of gears for helical milling, place the lead of the helix to be cut in the numerator and the lead of the milling machine in the denominator of a fraction; divide numerator and denominator into two factors each; and multiply each "pair" of factors by the *same* number until suitable numbers of teeth for the change gears are obtained. (One factor in the numerator and one in the denominator are considered as one "pair" in this calculation.)

Example: Assume that the lead of a machine is 10 inches, and that a helix having a 48-inch lead is to be cut. Following the method explained:

$$\frac{48}{10} = \frac{6 \times 8}{2 \times 5} = \frac{(6 \times 12) \times (8 \times 8)}{(2 \times 12) \times (5 \times 8)} = \frac{72 \times 64}{24 \times 40}$$

The gear having 72 teeth is placed on the worm-gear stud and meshes with the 24-tooth gear on the intermediate stud. On the same intermediate stud is then placed the gear having 64 teeth, which is driven by the gear having 40 teeth placed on the feed-screw. This makes the gears having 72 and 64 teeth the driven gears, and the gears having 24 and 40 teeth the driving gears. In general, for compound gearing, the following formula may be used:

$$\frac{\text{lead of helix to be cut}}{\text{lead of machine}} = \frac{\text{product of driven gears}}{\text{product of driving gears}}$$

Short-lead Milling.—If the lead to be milled is exceptionally short, the drive may be direct from the table feed-screw to the dividing head spindle to avoid excessive load on feed-screw and change-gears. If the table feed-screw has 4 threads per inch (usual standard), then

$$\text{Change-gear ratio} = \frac{\text{Lead to be milled}}{0.25} = \frac{\text{Driven gears}}{\text{Driving gears}}$$

For indexing, the number of teeth on the spindle change-gear should be some multiple of the number of divisions required, to permit indexing by disengaging and turning the gear.

Helix.—A helix is a curve generated by a point moving about a cylindrical surface (real or imaginary) at a constant rate in the direction of the cylinder's axis. The curvature of a screw thread is one common example of a helical curve.

Lead of Helix: The lead of a helix is the distance that it advances in an axial direction, in one complete turn about the cylindrical surface. To illustrate, the lead of a screw thread

equals the distance that a thread advances in one turn; it also equals the distance that a nut would advance in one turn.

Development of Helix: If one turn of a helical curve were unrolled onto a plane surface (as shown by diagram), the helix would become a straight line forming the hypotenuse of a right angle triangle. The length of one side of this triangle would equal the circumference of the cylinder with which the helix coincides, and the length of the other side of the triangle would equal the lead of the helix.

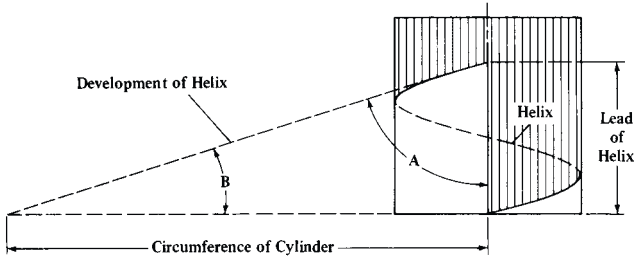

Helix Angles.—The triangular development of a helix has one angle *A* subtended by the circumference of the cylinder, and another angle *B* subtended by the lead of the helix. The term “helix angle” applies to angle *A*. For example, the helix angle of a helical gear, according to the general usage of the term, is always angle *A*, because this is the angle used in helical gear-designing formulas. Helix angle *A* would also be applied in milling the helical teeth of cutters, reamers, etc. Angle *A* of a gear or cutter tooth is a measure of its inclination relative to the axis of the gear or cutter.

Lead Angle: Angle *B* is applied to screw threads and worm threads and is referred to as the lead angle of the screw thread or worm. This angle *B* is a measure of the inclination of a screw thread from a plane that is perpendicular to the screw thread axis. Angle *B* is called the “lead angle” because it is subtended by the lead of the thread, and to distinguish it from the term “helix angle” as applied to helical gears.

Finding Helix Angle of Helical Gear: A helical gear tooth has an infinite number of helix angles, but the angle at the pitch diameter or mid-working depth is the one required in gear designing and gear cutting. This angle *A*, relative to the axis of the gear, is found as follows:

$$\tan \text{ helix angle} = \frac{3.1416 \times \text{pitch diameter of gear}}{\text{Lead of gear tooth}}$$

Finding Lead Angle of Screw Thread: The lead or helix angle at the pitch diameter of a screw thread usually is required when, for example, a thread milling cutter must be aligned with the thread. This angle measured from a plane perpendicular to the screw thread axis, is found as follows:

$$\tan \text{ lead angle} = \frac{\text{Lead of screw thread}}{3.1416 \times \text{pitch diameter of screw thread}}$$

Change Gears for Different Leads—0.670 Inch to 2.658 Inches

Lead in Inches	Driven	Driver	Driven	Driver	Lead in Inches	Driven	Driver	Driven	Driver	Lead in Inches	Driven	Driver	Driven	Driver
	Gear on Worm	First Gear on Stud	Second Gear on Stud	Gear on Screw		Gear on Worm	First Gear on Stud	Second Gear on Stud	Gear on Screw		Gear on Worm	First Gear on Stud	Second Gear on Stud	Gear on Screw
0.670	24	86	24	100	1.711	28	72	44	100	2.182	24	44	40	100
0.781	24	86	28	100	1.714	24	56	40	100	2.188	24	48	28	64
0.800	24	72	24	100	1.744	24	64	40	86	2.193	24	56	44	86
0.893	24	86	32	100	1.745	24	44	32	100	2.200	24	48	44	100
0.930	24	72	24	86	1.750	28	64	40	100	2.222	24	48	32	72
1.029	24	56	24	100	1.776	24	44	28	86	2.233	40	86	48	100
1.042	28	86	32	100	1.778	32	72	40	100	2.238	28	64	44	86
1.047	24	64	24	86	1.786	24	86	64	100	2.240	28	40	32	100
1.050	24	64	28	100	1.800	24	64	48	100	2.250	24	40	24	64
1.067	24	72	32	100	1.809	28	72	40	86	2.274	32	72	44	86
1.085	24	72	28	86	1.818	24	44	24	72	2.286	32	56	40	100
1.116	24	86	40	100	1.823	28	86	56	100	2.292	24	64	44	72
1.196	24	56	24	86	1.860	28	56	32	86	2.326	32	64	40	86
1.200	24	48	24	100	1.861	24	72	48	86	2.333	28	48	40	100
1.221	24	64	28	86	1.867	28	48	32	100	2.338	24	44	24	56
1.228	24	86	44	100	1.875	24	48	24	64	2.344	28	86	72	100
1.240	24	72	32	86	1.886	24	56	44	100	2.368	28	44	32	86
1.250	24	64	24	72	1.905	24	56	32	72	2.381	32	86	64	100
1.302	28	86	40	100	1.919	24	64	44	86	2.386	24	44	28	64
1.309	24	44	24	100	1.920	24	40	32	100	2.392	24	56	48	86
1.333	24	72	40	100	1.925	28	64	44	100	2.400	28	56	48	100
1.340	24	86	48	100	1.944	24	48	28	72	2.424	24	44	32	72
1.371	24	56	32	100	1.954	24	40	28	86	2.431	28	64	40	72
1.395	24	48	24	86	1.956	32	72	44	100	2.442	24	32	28	86
1.400	24	48	28	100	1.990	28	72	44	86	2.445	40	72	44	100
1.429	24	56	24	72	1.993	24	56	40	86	2.450	28	64	56	100
1.440	24	40	24	100	2.000	24	40	24	72	2.456	44	86	48	100
1.458	24	64	28	72	2.009	24	86	72	100	2.481	32	72	48	86
1.467	24	72	44	100	2.030	24	44	32	86	2.489	32	72	56	100
1.488	32	86	40	100	2.035	28	64	40	86	2.500	24	48	28	56
1.500	24	64	40	100	2.036	28	44	32	100	2.514	32	56	44	100
1.522	24	44	24	86	2.045	24	44	24	64	2.532	28	72	56	86
1.550	24	72	40	86	2.047	40	86	44	100	2.537	24	44	40	86
1.563	24	86	56	100	2.057	24	28	24	100	2.546	28	44	40	100
1.595	24	56	32	86	2.067	32	72	40	86	2.558	32	64	44	86
1.600	24	48	32	100	2.083	24	64	40	72	2.567	28	48	44	100
1.607	24	56	24	64	2.084	28	86	64	100	2.571	24	40	24	56
1.628	24	48	28	86	2.093	24	64	48	86	2.593	28	48	32	72
1.637	32	86	44	100	2.100	24	64	56	100	2.605	28	40	32	86
1.650	24	64	44	100	2.121	24	44	28	72	2.618	24	44	48	100
1.667	24	56	28	72	2.133	24	72	64	100	2.619	24	56	44	72
1.674	24	40	24	86	2.143	24	56	32	64	2.625	24	40	28	64
1.680	24	40	28	100	2.171	24	72	56	86	2.640	24	40	44	100
1.706	24	72	44	86	2.178	28	72	56	100	2.658	32	56	40	86

Change Gears for Different Leads—2.667 Inches to 4.040 Inches

Lead in Inches	Driven	Driver	Driven	Driver	Lead in Inches	Driven	Driver	Driven	Driver	Lead in Inches	Driven	Driver	Driven	Driver
	Gear on Worm	First Gear on Stud	Second Gear on Stud	Gear on Screw		Gear on Worm	First Gear on Stud	Second Gear on Stud	Gear on Screw		Gear on Worm	First Gear on Stud	Second Gear on Stud	Gear on Screw
2.667	40	72	48	100	3.140	24	86	72	64	3.588	72	56	24	86
2.674	28	64	44	72	3.143	40	56	44	100	3.600	72	48	24	100
2.678	24	56	40	64	3.150	28	100	72	64	3.618	56	72	40	86
2.679	32	86	72	100	3.175	32	56	40	72	3.636	24	44	32	48
2.700	24	64	72	100	3.182	28	44	32	64	3.637	48	44	24	72
2.713	28	48	40	86	3.189	32	56	48	86	3.646	40	48	28	64
2.727	24	44	32	64	3.190	24	86	64	56	3.655	40	56	44	86
2.743	24	56	64	100	3.198	40	64	44	86	3.657	64	56	32	100
2.750	40	64	44	100	3.200	28	100	64	56	3.663	72	64	28	86
2.778	32	64	40	72	3.214	24	56	48	64	3.667	40	48	44	100
2.791	28	56	48	86	3.225	24	100	86	64	3.673	24	28	24	56
2.800	24	24	28	100	3.241	28	48	40	72	3.684	44	86	72	100
2.812	24	32	24	64	3.256	24	24	28	86	3.686	86	56	24	100
2.828	28	44	32	72	3.267	28	48	56	100	3.704	32	48	40	72
2.843	40	72	44	86	3.273	24	40	24	44	3.721	24	24	32	86
2.845	32	72	64	100	3.275	44	86	64	100	3.733	48	72	56	100
2.849	28	64	56	86	3.281	24	32	28	64	3.750	24	32	24	48
2.857	24	48	32	56	3.300	44	64	48	100	3.763	86	64	28	100
2.865	44	86	56	100	3.308	32	72	64	86	3.771	44	56	48	100
2.867	86	72	24	100	3.333	32	64	48	72	3.772	24	28	44	100
2.880	24	40	48	100	3.345	28	100	86	72	3.799	56	48	28	86
2.894	28	72	64	86	3.349	40	86	72	100	3.809	24	28	32	72
2.909	32	44	40	100	3.360	56	40	24	100	3.810	64	56	24	72
2.917	24	64	56	72	3.383	32	44	40	86	3.818	24	40	28	44
2.924	32	56	44	86	3.403	28	64	56	72	3.819	40	64	44	72
2.933	44	72	48	100	3.409	24	44	40	64	3.822	86	72	32	100
2.934	32	48	44	100	3.411	32	48	44	86	3.837	24	32	44	86
2.946	24	56	44	64	3.422	44	72	56	100	3.840	64	40	24	100
2.960	28	44	40	86	3.428	24	40	32	56	3.850	44	64	56	100
2.977	40	86	64	100	3.429	40	28	24	100	3.876	24	72	100	86
2.984	28	48	44	86	3.438	24	48	44	64	3.889	32	64	56	72
3.000	24	40	28	56	3.488	40	64	48	86	3.896	24	44	40	56
3.030	24	44	40	72	3.491	64	44	24	100	3.907	56	40	24	86
3.044	24	44	48	86	3.492	32	56	44	72	3.911	44	72	64	100
3.055	28	44	48	100	3.500	40	64	56	100	3.920	28	40	56	100
3.056	32	64	44	72	3.520	32	40	44	100	3.927	72	44	24	100
3.070	24	40	44	86	3.535	28	44	40	72	3.929	32	56	44	64
3.080	28	40	44	100	3.552	56	44	24	86	3.977	28	44	40	64
3.086	24	56	72	100	3.556	40	72	64	100	3.979	44	72	56	86
3.101	40	72	48	86	3.564	56	44	28	100	3.987	24	28	40	86
3.111	28	40	32	72	3.565	28	48	44	72	4.000	24	40	32	48
3.117	24	44	32	56	3.571	24	48	40	56	4.011	28	48	44	64
3.125	28	56	40	64	3.572	48	86	64	100	4.019	72	86	48	100
3.126	48	86	56	100	3.582	44	40	28	86	4.040	32	44	40	72

Change Gears for Different Leads—4.059 Inches to 5.568 Inches

Lead in Inches	Driven		Driver		Lead in Inches	Driven		Driver		Lead in Inches	Driven		Driver	
	Gear on Worm	First Gear on Stud	Second Gear on Stud	Gear on Screw		Gear on Worm	First Gear on Stud	Second Gear on Stud	Gear on Screw		Gear on Worm	First Gear on Stud	Second Gear on Stud	Gear on Screw
4.059	32	44	48	86	4.567	72	44	24	86	5.105	28	48	56	64
4.060	64	44	24	86	4.572	40	56	64	100	5.116	44	24	24	86
4.070	28	32	40	86	4.582	72	44	28	100	5.119	86	56	24	72
4.073	64	44	28	100	4.583	44	64	48	72	5.120	64	40	32	100
4.074	32	48	44	72	4.584	32	48	44	64	5.133	56	48	44	100
4.091	24	44	48	64	4.651	40	24	24	86	5.134	44	24	28	100
4.093	32	40	44	86	4.655	64	44	32	100	5.142	72	56	40	100
4.114	48	28	24	100	4.667	28	40	32	48	5.143	24	28	24	40
4.125	24	40	44	64	4.675	24	28	24	44	5.156	44	32	24	64
4.135	40	72	64	86	4.687	40	32	24	64	5.160	86	40	24	100
4.144	56	44	28	86	4.688	56	86	72	100	5.168	100	72	32	86
4.167	28	48	40	56	4.691	86	44	24	100	5.185	28	24	32	72
4.186	72	64	32	86	4.714	44	40	24	56	5.186	64	48	28	72
4.200	48	64	56	100	4.736	64	44	28	86	5.195	32	44	40	56
4.242	28	44	32	48	4.762	40	28	24	72	5.209	100	64	24	72
4.253	64	56	32	86	4.773	24	32	28	44	5.210	64	40	28	86
4.264	40	48	44	86	4.778	86	72	40	100	5.226	86	64	28	72
4.267	64	48	32	100	4.784	72	56	32	86	5.233	72	64	40	86
4.278	28	40	44	72	4.785	48	28	24	86	5.236	72	44	32	100
4.286	24	28	24	48	4.800	48	24	24	100	5.238	44	28	24	72
4.300	86	56	28	100	4.813	44	40	28	64	5.250	24	32	28	40
4.320	72	40	24	100	4.821	72	56	24	64	5.256	86	72	44	100
4.341	48	72	56	86	4.849	32	44	48	72	5.280	48	40	44	100
4.342	64	48	28	86	4.861	40	32	28	72	5.303	28	44	40	48
4.361	100	64	24	86	4.884	48	64	56	86	5.316	40	28	32	86
4.363	24	40	32	44	4.889	32	40	44	72	5.328	72	44	28	86
4.364	40	44	48	100	4.898	24	28	32	56	5.333	40	24	32	100
4.365	40	56	44	72	4.900	56	32	28	100	5.347	44	64	56	72
4.375	24	24	28	64	4.911	40	56	44	64	5.348	44	32	28	72
4.386	24	28	44	86	4.914	86	56	32	100	5.357	40	28	24	64
4.400	24	24	44	100	4.950	56	44	28	72	5.358	64	86	72	100
4.444	64	56	28	72	4.961	64	48	32	86	5.375	86	64	40	100
4.465	64	40	24	86	4.978	56	72	64	100	5.400	72	32	24	100
4.466	48	40	32	86	4.984	100	56	24	86	5.413	64	44	32	86
4.477	44	32	28	86	5.000	24	24	28	56	5.426	40	24	28	86
4.479	86	64	24	72	5.017	86	48	28	100	5.427	40	48	56	86
4.480	56	40	32	100	5.023	72	40	24	86	5.444	56	40	28	72
4.500	72	64	40	100	5.029	44	28	32	100	5.455	48	44	28	56
4.522	100	72	28	86	5.040	72	40	28	100	5.469	40	32	28	64
4.537	56	48	28	72	5.074	40	44	48	86	5.473	86	44	28	100
4.545	24	44	40	48	5.080	64	56	32	72	5.486	64	28	24	100
4.546	28	44	40	56	5.088	100	64	28	86	5.500	44	40	24	48
4.548	44	72	64	86	5.091	56	44	40	100	5.556	40	24	24	72
4.558	56	40	28	86	5.093	40	48	44	72	5.568	56	44	28	64

Change Gears for Different Leads—5.581 Inches to 7.500 Inches

Lead in Inches	Driven	Driver	Driven	Driver	Lead in Inches	Driven	Driver	Driven	Driver	Lead in Inches	Driven	Driver	Driven	Driver
	Gear on Worm	First Gear on Stud	Second Gear on Stud	Gear on Screw		Gear on Worm	First Gear on Stud	Second Gear on Stud	Gear on Screw		Gear on Worm	First Gear on Stud	Second Gear on Stud	Gear on Screw
5.581	64	32	24	86	6.172	72	28	24	100	6.825	86	56	32	72
5.582	48	24	24	86	6.202	40	24	32	86	6.857	32	28	24	40
5.600	56	24	24	100	6.222	64	40	28	72	6.875	44	24	24	64
5.625	48	32	24	64	6.234	32	28	24	44	6.880	86	40	32	100
5.657	56	44	32	72	6.250	24	24	40	64	6.944	100	48	24	72
5.698	56	32	28	86	6.255	86	44	32	100	6.945	100	56	28	72
5.714	48	28	24	72	6.279	72	64	48	86	6.968	86	48	28	72
5.730	40	48	44	64	6.286	44	40	32	56	6.977	48	32	40	86
5.733	86	48	32	100	6.300	72	32	28	100	6.982	64	44	48	100
5.756	72	64	44	86	6.343	100	44	24	86	6.984	44	28	32	72
5.759	86	56	24	64	6.350	40	28	32	72	7.000	28	24	24	40
5.760	72	40	32	100	6.364	56	44	24	48	7.013	72	44	24	56
5.788	64	72	56	86	6.379	64	28	24	86	7.040	64	40	44	100
5.814	100	64	32	86	6.396	44	32	40	86	7.071	56	44	40	72
5.818	64	44	40	100	6.400	64	24	24	100	7.104	56	44	48	86
5.833	28	24	24	48	6.417	44	40	28	48	7.106	100	72	44	86
5.847	64	56	44	86	6.429	24	28	24	32	7.111	64	40	32	72
5.848	44	28	32	86	6.450	86	64	48	100	7.130	44	24	28	72
5.861	72	40	28	86	6.460	100	72	40	86	7.143	40	28	32	64
5.867	44	24	32	100	6.465	64	44	32	72	7.159	72	44	28	64
5.893	44	32	24	56	6.482	56	48	40	72	7.163	56	40	44	86
5.912	86	64	44	100	6.512	56	24	24	86	7.167	86	40	24	72
5.920	56	44	40	86	6.515	86	44	24	72	7.176	72	28	24	86
5.926	64	48	32	72	6.534	56	24	28	100	7.200	72	24	24	100
5.952	100	56	24	72	6.545	48	40	24	44	7.268	100	64	40	86
5.954	64	40	32	86	6.548	44	48	40	56	7.272	64	44	28	56
5.969	44	24	28	86	6.563	56	32	24	64	7.273	32	24	24	44
5.972	86	48	24	72	6.578	72	56	44	86	7.292	56	48	40	64
5.980	72	56	40	86	6.600	48	32	44	100	7.310	44	28	40	86
6.000	48	40	28	56	6.645	100	56	32	86	7.314	64	28	32	100
6.016	44	32	28	64	6.667	64	48	28	56	7.326	72	32	28	86
6.020	86	40	28	100	6.689	86	72	56	100	7.330	86	44	24	64
6.061	40	44	32	48	6.697	100	56	24	64	7.333	44	24	40	100
6.077	100	64	28	72	6.698	72	40	32	86	7.334	44	40	32	48
6.089	72	44	32	86	6.719	86	48	24	64	7.347	48	28	24	56
6.109	56	44	48	100	6.720	56	40	48	100	7.371	86	56	48	100
6.112	24	24	44	72	6.735	44	28	24	56	7.372	86	28	24	100
6.122	40	28	24	56	6.750	72	40	24	64	7.400	100	44	28	86
6.125	56	40	28	64	6.757	86	56	44	100	7.408	40	24	32	72
6.137	72	44	24	64	6.766	64	44	40	86	7.424	56	44	28	48
6.140	48	40	44	86	6.784	100	48	28	86	7.442	64	24	24	86
6.143	86	56	40	100	6.806	56	32	28	72	7.465	86	64	40	72
6.160	56	40	44	100	6.818	40	32	24	44	7.467	64	24	28	100
6.171	72	56	48	100	6.822	44	24	32	86	7.500	48	24	24	64

Change Gears for Different Leads—7.525 Inches to 9.598 Inches

Lead in Inches	Driven		Driver		Lead in Inches	Driven		Driver		Lead in Inches	Driven		Driver	
	Gear on Worm	First Gear on Stud	Second Gear on Stud	Gear on Screw		Gear on Worm	First Gear on Stud	Second Gear on Stud	Gear on Screw		Gear on Worm	First Gear on Stud	Second Gear on Stud	Gear on Screw
7.525	86	32	28	100	8.140	56	32	40	86	8.800	48	24	44	100
7.543	48	28	44	100	8.145	64	44	56	100	8.838	100	44	28	72
7.576	100	44	24	72	8.148	64	48	44	72	8.839	72	56	44	64
7.597	56	24	28	86	8.149	44	24	32	72	8.909	56	40	28	44
7.601	86	44	28	72	8.163	40	28	32	56	8.929	100	48	24	56
7.611	72	44	40	86	8.167	56	40	28	48	8.930	64	40	48	86
7.619	64	48	32	56	8.182	48	32	24	44	8.953	56	32	44	86
7.620	64	28	24	72	8.186	64	40	44	86	8.959	86	48	28	56
7.636	56	40	24	44	8.212	86	64	44	72	8.960	64	40	56	100
7.639	44	32	40	72	8.229	72	28	32	100	8.980	44	28	32	56
7.644	86	72	64	100	8.250	44	32	24	40	9.000	48	32	24	40
7.657	56	32	28	64	8.306	100	56	40	86	9.044	100	72	56	86
7.674	72	48	44	86	8.312	64	44	32	56	9.074	56	24	28	72
7.675	48	32	44	86	8.333	40	24	24	48	9.091	40	24	24	44
7.679	86	48	24	56	8.334	40	24	28	56	9.115	100	48	28	64
7.680	64	40	48	100	8.361	86	40	28	72	9.134	72	44	48	86
7.700	56	32	44	100	8.372	72	24	24	86	9.137	100	56	44	86
7.714	72	40	24	56	8.377	86	44	24	56	9.143	64	40	32	56
7.752	100	48	32	86	8.400	72	24	28	100	9.164	72	44	56	100
7.778	32	24	28	48	8.437	72	32	24	64	9.167	44	24	24	48
7.792	40	28	24	44	8.457	100	44	32	86	9.210	72	40	44	86
7.813	100	48	24	64	8.484	32	24	28	44	9.214	86	40	24	56
7.815	56	40	48	86	8.485	64	44	28	48	9.260	100	48	32	72
7.818	86	44	40	100	8.485	56	44	32	48	9.302	48	24	40	86
7.838	86	48	28	64	8.506	64	28	32	86	9.303	56	28	40	86
7.855	72	44	48	100	8.523	100	44	24	64	9.333	64	40	28	48
7.857	44	24	24	56	8.527	44	24	40	86	9.334	32	24	28	40
7.872	44	28	32	64	8.532	86	56	40	72	9.351	48	28	24	44
7.875	72	40	28	64	8.534	64	24	32	100	9.375	48	32	40	64
7.883	86	48	44	100	8.552	86	44	28	64	9.382	86	44	48	100
7.920	72	40	44	100	8.556	56	40	44	72	9.385	86	56	44	72
7.936	100	56	32	72	8.572	64	32	24	56	9.406	86	40	28	64
7.954	40	32	28	44	8.572	48	24	24	56	9.428	44	28	24	40
7.955	56	44	40	64	8.594	44	32	40	64	9.429	48	40	44	56
7.963	86	48	32	72	8.600	86	24	24	100	9.460	86	40	44	100
7.974	48	28	40	86	8.640	72	40	48	100	9.472	64	44	56	86
7.994	100	64	44	86	8.681	100	64	40	72	9.524	40	28	32	48
8.000	64	32	40	100	8.682	64	24	28	86	9.545	72	44	28	48
8.021	44	32	28	48	8.687	86	44	32	72	9.546	56	32	24	44
8.035	72	56	40	64	8.721	100	32	24	86	9.547	56	44	48	64
8.063	86	40	24	64	8.727	48	40	32	44	9.549	100	64	44	72
8.081	64	44	40	72	8.730	44	28	40	72	9.556	86	40	32	72
8.102	100	48	28	72	8.750	28	24	24	32	9.569	72	28	32	86
8.119	64	44	48	86	8.772	48	28	44	86	9.598	86	56	40	64

Change Gears for Different Leads—9.600 Inches to 12.375 Inches

Lead in Inches	Driven		Driver		Lead in Inches	Driven		Driver		Lead in Inches	Driven		Driver	
	Gear on Worm	First Gear on Stud	Second Gear on Stud	Gear on Screw		Gear on Worm	First Gear on Stud	Second Gear on Stud	Gear on Screw		Gear on Worm	First Gear on Stud	Second Gear on Stud	Gear on Screw
9.600	72	24	32	100	10.370	64	24	28	72	11.314	72	28	44	100
9.625	44	32	28	40	10.371	64	48	56	72	11.363	100	44	24	48
9.643	72	32	24	56	10.390	40	28	32	44	11.401	86	44	28	48
9.675	86	64	72	100	10.417	100	32	24	72	11.429	32	24	24	28
9.690	100	48	40	86	10.419	64	40	56	86	11.454	72	40	28	44
9.697	64	48	32	44	10.451	86	32	28	72	11.459	44	24	40	64
9.723	40	24	28	48	10.467	72	32	40	86	11.467	86	24	32	100
9.741	100	44	24	56	10.473	72	44	64	100	11.512	72	32	44	86
9.768	72	48	56	86	10.476	44	24	32	56	11.518	86	28	24	64
9.773	86	44	24	48	10.477	48	28	44	72	11.520	72	40	64	100
9.778	64	40	44	72	10.500	56	32	24	40	11.574	100	48	40	72
9.796	64	28	24	56	10.558	86	56	44	64	11.629	100	24	24	86
9.818	72	40	24	44	10.571	100	44	40	86	11.638	64	40	32	44
9.822	44	32	40	56	10.606	56	44	40	48	11.667	56	24	24	48
9.828	86	28	32	100	10.631	64	28	40	86	11.688	72	44	40	56
9.844	72	32	28	64	10.655	72	44	56	86	11.695	64	28	44	86
9.900	72	32	44	100	10.659	100	48	44	86	11.719	100	32	24	64
9.921	100	56	40	72	10.667	64	40	48	72	11.721	72	40	56	86
9.923	64	24	32	86	10.694	44	24	28	48	11.728	86	40	24	44
9.943	100	44	28	64	10.713	40	28	24	32	11.733	64	24	44	100
9.954	86	48	40	72	10.714	48	32	40	56	11.757	86	32	28	64
9.967	100	56	48	86	10.750	86	40	24	48	11.785	72	48	44	56
9.968	100	28	24	86	10.800	72	32	48	100	11.786	44	28	24	32
10.000	56	28	24	48	10.853	56	24	40	86	11.825	86	32	44	100
10.033	86	24	28	100	10.859	86	44	40	72	11.905	100	28	24	72
10.046	72	40	48	86	10.909	72	44	32	48	11.938	56	24	44	86
10.057	64	28	44	100	10.913	100	56	44	72	11.944	86	24	24	72
10.078	86	32	24	64	10.937	56	32	40	64	11.960	72	28	40	86
10.080	72	40	56	100	10.945	86	44	56	100	12.000	48	24	24	40
10.101	100	44	32	72	10.949	86	48	44	72	12.031	56	32	44	64
10.159	64	28	32	72	10.972	64	28	48	100	12.040	86	40	56	100
10.175	100	32	28	86	11.000	44	24	24	40	12.121	40	24	32	44
10.182	64	40	28	44	11.021	72	28	24	56	12.153	100	32	28	72
10.186	44	24	40	72	11.057	86	56	72	100	12.178	72	44	64	86
10.209	56	24	28	64	11.111	40	24	32	48	12.216	86	44	40	64
10.228	72	44	40	64	11.137	56	32	28	44	12.222	44	24	32	48
10.233	48	24	44	86	11.160	100	56	40	64	12.245	48	28	40	56
10.238	86	28	24	72	11.163	72	24	32	86	12.250	56	32	28	40
10.267	56	24	44	100	11.169	86	44	32	56	12.272	72	32	24	44
10.286	48	28	24	40	11.198	86	48	40	64	12.277	100	56	44	64
10.312	48	32	44	64	11.200	56	24	48	100	12.286	86	28	40	100
10.313	72	48	44	64	11.225	44	28	40	56	12.318	86	48	44	64
10.320	86	40	48	100	11.250	72	24	24	64	12.343	72	28	48	100
10.336	100	72	64	86	11.313	64	44	56	72	12.375	72	40	44	64

Change Gears for Different Leads—12.403 Inches to 16.000 Inches

Lead in Inches	Driven		Driver		Lead in Inches	Driven		Driver		Lead in Inches	Driven		Driver	
	Gear on Worm	First Gear on Stud	Second Gear on Stud	Gear on Screw		Gear on Worm	First Gear on Stud	Second Gear on Stud	Gear on Screw		Gear on Worm	First Gear on Stud	Second Gear on Stud	Gear on Screw
12.403	64	24	40	86	13.438	86	24	24	64	14.668	44	24	32	40
12.444	64	40	56	72	13.469	48	28	44	56	14.694	72	28	32	56
12.468	64	28	24	44	13.500	72	32	24	40	14.743	86	28	48	100
12.500	40	24	24	32	13.514	86	28	44	100	14.780	86	40	44	64
12.542	86	40	28	48	13.566	100	24	28	86	14.800	100	44	56	86
12.508	86	44	64	100	13.611	56	24	28	48	14.815	64	24	40	72
12.558	72	32	48	86	13.636	48	32	40	44	14.849	56	24	28	44
12.571	64	40	44	56	13.643	64	24	44	86	14.880	100	48	40	56
12.572	44	28	32	40	13.650	86	28	32	72	14.884	64	28	56	86
12.600	72	32	56	100	13.672	100	32	28	64	14.931	86	32	40	72
12.627	100	44	40	72	13.682	86	40	28	44	14.933	64	24	56	100
12.686	100	44	48	86	13.713	64	40	48	56	14.950	100	56	72	86
12.698	64	28	40	72	13.715	64	28	24	40	15.000	48	24	24	32
12.727	64	32	28	44	13.750	44	24	24	32	15.050	86	32	56	100
12.728	56	24	24	44	13.760	86	40	64	100	15.150	100	44	32	48
12.732	100	48	44	72	13.889	100	24	24	72	15.151	100	44	48	72
12.758	64	28	48	86	13.933	86	48	56	72	15.202	86	44	56	72
12.791	100	40	44	86	13.935	86	24	28	72	15.238	64	28	48	72
12.798	86	48	40	56	13.953	72	24	40	86	15.239	64	28	32	48
12.800	64	28	56	100	13.960	86	44	40	56	15.272	56	40	48	44
12.834	56	40	44	48	13.968	64	28	44	72	15.278	44	24	40	48
12.857	72	28	32	64	14.000	56	24	24	40	15.279	100	40	44	72
12.858	48	28	24	32	14.025	72	44	48	56	15.306	100	28	24	56
12.900	86	32	48	100	14.026	72	28	24	44	15.349	72	24	44	86
12.963	56	24	40	72	14.063	72	32	40	64	15.357	86	28	24	48
12.987	100	44	32	56	14.071	86	44	72	100	15.429	72	40	48	56
13.020	100	48	40	64	14.078	86	48	44	56	15.469	72	32	44	64
13.024	56	24	48	86	14.142	72	40	44	56	15.480	86	40	72	100
13.030	86	44	32	48	14.204	100	44	40	64	15.504	100	48	64	86
13.062	64	28	32	56	14.260	56	24	44	72	15.556	64	32	56	72
13.082	100	64	72	86	14.286	40	24	24	28	15.584	48	28	40	44
13.090	72	40	32	44	14.318	72	32	28	44	15.625	100	24	24	64
13.096	44	28	40	48	14.319	72	44	56	64	15.636	86	40	32	44
13.125	72	32	28	48	14.322	100	48	44	64	15.677	86	32	28	48
13.139	86	40	44	72	14.333	86	40	32	48	15.714	44	24	24	28
13.157	72	28	44	86	14.352	72	28	48	86	15.750	72	32	28	40
13.163	86	28	24	56	14.400	72	24	48	100	15.767	86	24	44	100
13.200	72	24	44	100	14.536	100	32	40	86	15.873	100	56	64	72
13.258	100	44	28	48	14.545	64	24	24	44	15.874	100	28	32	72
13.289	100	28	32	86	14.583	56	32	40	48	15.909	100	40	28	44
13.333	64	24	24	48	14.584	40	24	28	32	15.925	86	48	64	72
13.393	100	56	48	64	14.651	72	32	56	86	15.926	86	24	32	72
13.396	72	40	64	86	14.659	86	44	48	64	15.989	100	32	44	86
13.437	86	32	28	56	14.667	64	40	44	48	16.000	64	24	24	40

Change Gears for Different Leads—16.042 Inches to 21.39 Inches

Lead in Inches	Driven	Driver	Driven	Driver	Lead in Inches	Driven	Driver	Driven	Driver	Lead in Inches	Driven	Driver	Driven	Driver
	Gear on Worm	First Gear on Stud	Second Gear on Stud	Gear on Screw		Gear on Worm	First Gear on Stud	Second Gear on Stud	Gear on Screw		Gear on Worm	First Gear on Stud	Second Gear on Stud	Gear on Screw
16.042	56	24	44	64	17.442	100	32	48	86	19.350	86	32	72	100
16.043	44	24	28	32	17.454	64	40	48	44	19.380	100	24	40	86
16.071	72	32	40	56	17.500	56	24	24	32	19.394	64	24	32	44
16.125	86	32	24	40	17.550	86	28	32	56	19.444	40	24	28	24
16.204	100	24	28	72	17.677	100	44	56	72	19.480	100	28	24	44
16.233	100	44	40	56	17.679	72	32	44	56	19.531	100	32	40	64
16.280	100	40	56	86	17.778	64	24	32	48	19.535	72	24	56	86
16.288	86	44	40	48	17.858	100	24	24	56	19.545	86	24	24	44
16.296	64	24	44	72	17.917	86	24	32	64	19.590	64	28	48	56
16.327	64	28	40	56	17.918	86	24	24	48	19.635	72	40	48	44
16.333	56	24	28	40	17.959	64	28	44	56	19.642	100	40	44	56
16.364	72	24	24	44	18.000	72	24	24	40	19.643	44	28	40	32
16.370	100	48	44	56	18.181	56	28	40	44	19.656	86	28	64	100
16.423	86	32	44	72	18.182	48	24	40	44	19.687	72	32	56	64
16.456	72	28	64	100	18.229	100	32	28	48	19.710	86	40	44	48
16.500	72	40	44	48	18.273	100	28	44	86	19.840	100	28	40	72
16.612	100	28	40	86	18.285	64	28	32	40	19.886	100	44	56	64
16.623	64	28	32	44	18.333	56	28	44	48	19.887	100	32	28	44
16.667	56	28	40	48	18.367	72	28	40	56	19.908	86	24	40	72
16.722	86	40	56	72	18.428	86	28	24	40	19.934	100	28	48	86
16.744	72	24	48	86	18.476	86	32	44	64	20.00	72	24	32	48
16.752	86	44	48	56	18.519	100	24	32	72	20.07	86	24	56	100
16.753	86	28	24	44	18.605	100	40	64	86	20.09	100	56	72	64
16.797	86	32	40	64	18.663	100	64	86	72	20.16	86	48	72	64
16.800	72	24	56	100	18.667	64	24	28	40	20.20	100	44	64	72
16.875	72	32	48	64	18.700	72	44	64	56	20.35	100	32	56	86
16.892	86	40	44	56	18.750	100	32	24	40	20.36	64	40	56	44
16.914	100	44	64	86	18.750	72	32	40	48	20.41	100	28	32	56
16.969	64	44	56	48	18.770	86	28	44	72	20.42	56	24	28	32
16.970	64	24	28	44	18.812	86	32	28	40	20.45	72	32	40	44
17.045	100	32	24	44	18.858	48	28	44	40	20.48	86	48	64	56
17.046	100	44	48	64	18.939	100	44	40	48	20.57	72	40	64	56
17.062	86	28	40	72	19.029	100	44	72	86	20.63	72	32	44	48
17.101	86	44	56	64	19.048	40	24	32	28	20.74	64	24	56	72
17.102	86	32	28	44	19.090	56	32	48	44	20.78	64	28	40	44
17.141	64	32	48	56	19.091	72	24	28	44	20.83	100	32	48	72
17.143	64	28	24	32	19.096	100	32	44	72	20.90	86	32	56	72
17.144	48	24	24	28	19.111	86	40	64	72	20.93	100	40	72	86
17.188	100	40	44	64	19.136	72	28	64	86	20.95	64	28	44	48
17.200	86	32	64	100	19.197	86	32	40	56	21.00	56	32	48	40
17.275	86	56	72	64	19.200	72	24	64	100	21.12	86	32	44	56
17.361	100	32	40	72	19.250	56	32	44	40	21.32	100	24	44	86
17.364	64	24	56	86	19.285	72	32	48	56	21.33	100	56	86	72
17.373	86	44	64	72	19.286	72	28	24	32	21.39	44	24	28	24

Change Gears for Different Leads—21.43 Inches to 32.09 Inches

Lead in Inches	Driven		Driver		Lead in Inches	Driven		Driver		Lead in Inches	Driven		Driver	
	Gear on Worm	First Gear on Stud	Second Gear on Stud	Gear on Screw		Gear on Worm	First Gear on Stud	Second Gear on Stud	Gear on Screw		Gear on Worm	First Gear on Stud	Second Gear on Stud	Gear on Screw
21.43	100	40	48	56	24.88	100	72	86	48	28.05	72	28	48	44
21.48	100	32	44	64	24.93	64	28	48	44	28.06	100	28	44	56
21.50	86	24	24	40	25.00	72	24	40	48	28.13	100	40	72	64
21.82	72	44	64	48	25.08	86	24	28	40	28.15	86	28	44	48
21.88	100	40	56	64	25.09	86	40	56	48	28.29	72	28	44	40
21.90	86	24	44	72	25.13	86	44	72	56	28.41	100	32	40	44
21.94	86	28	40	56	25.14	64	28	44	40	28.57	100	56	64	40
21.99	86	44	72	64	25.45	64	44	56	32	28.64	72	44	56	32
22.00	64	32	44	40	25.46	100	24	44	72	28.65	100	32	44	48
22.04	72	28	48	56	25.51	100	28	40	56	28.67	86	40	64	48
22.11	86	28	72	100	25.57	100	64	72	44	29.09	64	24	48	44
22.22	100	40	64	72	25.60	86	28	40	48	29.17	100	40	56	48
22.34	86	44	64	56	25.67	56	24	44	40	29.22	100	56	72	44
22.40	86	32	40	48	25.71	72	24	48	56	29.32	86	48	72	44
22.50	72	24	48	64	25.72	72	24	24	28	29.34	64	24	44	40
22.73	100	24	24	44	25.80	86	24	72	100	29.39	72	28	64	56
22.80	86	48	56	44	25.97	100	44	64	56	29.56	86	32	44	40
22.86	64	24	24	28	26.04	100	32	40	48	29.76	100	28	40	48
22.91	72	44	56	40	26.06	86	44	64	48	29.86	100	40	86	72
22.92	100	40	44	48	26.16	100	32	72	86	29.90	100	28	72	86
22.93	86	24	64	100	26.18	72	40	64	44	30.00	56	28	48	32
23.04	86	56	72	48	26.19	44	24	40	28	30.23	86	32	72	64
23.14	100	24	40	72	26.25	72	32	56	48	30.30	100	48	64	44
23.26	100	32	64	86	26.33	86	28	48	56	30.48	64	24	32	28
23.33	64	32	56	48	26.52	100	44	56	48	30.54	100	44	86	64
23.38	72	28	40	44	26.58	100	28	64	86	30.56	44	24	40	24
23.44	100	48	72	64	26.67	64	28	56	48	30.61	100	28	48	56
23.45	86	40	48	44	26.79	100	48	72	56	30.71	86	24	48	56
23.52	86	32	56	64	26.88	86	28	56	64	30.72	86	24	24	28
23.57	72	28	44	48	27.00	72	32	48	40	30.86	72	28	48	40
23.81	100	48	64	56	27.13	100	24	56	86	31.01	100	24	64	86
23.89	86	32	64	72	27.15	100	44	86	72	31.11	64	24	56	48
24.00	64	40	72	48	27.22	56	24	28	24	31.25	100	28	56	64
24.13	86	28	44	56	27.27	100	40	48	44	31.27	86	40	64	44
24.19	86	40	72	64	27.30	86	28	64	72	31.35	86	32	56	48
24.24	64	24	40	44	27.34	100	32	56	64	31.36	86	24	28	32
24.31	100	32	56	72	27.36	86	40	56	44	31.43	64	28	44	32
24.43	86	32	40	44	27.43	64	28	48	40	31.50	72	32	56	40
24.44	44	24	32	24	27.50	56	32	44	28	31.75	100	72	64	28
24.54	72	32	48	44	27.64	86	40	72	56	31.82	100	44	56	40
24.55	100	32	44	56	27.78	100	32	64	72	31.85	86	24	64	72
24.57	86	40	64	56	27.87	86	24	56	72	31.99	100	56	86	48
24.64	86	24	44	64	27.92	86	28	40	44	32.00	64	28	56	40
24.75	72	32	44	40	28.00	100	64	86	48	32.09	56	24	44	32

Change Gears for Different Leads—32.14 Inches to 60.00 Inches

Lead in Inches	Driven	Driver	Driven	Driver	Lead in Inches	Driven	Driver	Driven	Driver	Lead in Inches	Driven	Driver	Driven	Driver
	Gear on Worm	First Gear on Stud	Second Gear on Stud	Gear on Screw		Gear on Worm	First Gear on Stud	Second Gear on Stud	Gear on Screw		Gear on Worm	First Gear on Stud	Second Gear on Stud	Gear on Screw
32.14	100	56	72	40	38.20	100	24	44	48	46.07	86	28	72	48
32.25	86	48	72	40	38.39	100	40	86	56	46.67	64	24	56	32
32.41	100	24	56	72	38.57	72	28	48	32	46.88	100	32	72	48
32.47	100	28	40	44	38.89	56	24	40	24	47.15	72	24	44	28
32.58	86	24	40	44	38.96	100	28	48	44	47.62	100	28	64	48
32.73	72	32	64	44	39.09	86	32	64	44	47.78	86	24	64	48
32.74	100	28	44	48	39.29	100	28	44	40	47.99	100	32	86	56
32.85	86	24	44	48	39.42	86	24	44	40	48.00	72	24	64	40
33.00	72	24	44	40	39.49	86	28	72	56	48.38	86	32	72	40
33.33	100	24	32	40	39.77	100	32	56	44	48.61	100	24	56	48
33.51	86	28	48	44	40.00	72	24	64	48	48.86	100	40	86	44
33.59	100	64	86	40	40.18	100	32	72	56	48.89	64	24	44	24
33.79	86	28	44	40	40.31	86	32	72	48	49.11	100	28	44	32
33.94	64	24	56	44	40.72	100	44	86	48	49.14	86	28	64	40
34.09	100	48	72	44	40.82	100	28	64	56	49.27	86	24	44	32
34.20	86	44	56	32	40.91	100	40	72	44	49.77	100	24	86	72
34.29	72	48	64	28	40.95	86	28	64	48	50.00	100	28	56	40
34.38	100	32	44	40	40.96	86	24	32	28	50.17	86	24	56	40
34.55	86	32	72	56	41.14	72	28	64	40	50.26	86	28	72	44
34.72	100	24	40	48	41.25	72	24	44	32	51.14	100	32	72	44
34.88	100	24	72	86	41.67	100	32	64	48	51.19	86	24	40	28
34.90	100	56	86	44	41.81	86	24	56	48	51.43	72	28	64	32
35.00	72	24	56	48	41.91	64	24	44	28	51.95	100	28	64	44
35.10	86	28	64	56	41.99	100	32	86	64	52.12	86	24	64	44
35.16	100	32	72	64	42.00	72	24	56	40	52.50	72	24	56	32
35.18	86	44	72	40	42.23	86	28	44	32	53.03	100	24	56	44
35.36	72	32	44	28	42.66	100	28	86	72	53.33	64	24	56	28
35.56	64	24	32	24	42.78	56	24	44	24	53.57	100	28	72	48
35.71	100	32	64	56	42.86	100	28	48	40	53.75	86	24	48	32
35.72	100	24	24	28	43.00	86	32	64	40	54.85	100	28	86	56
35.83	86	32	64	48	43.64	72	24	64	44	55.00	72	24	44	24
36.00	72	32	64	40	43.75	100	32	56	40	55.28	86	28	72	40
36.36	100	44	64	40	43.98	86	32	72	44	55.56	100	24	32	24
36.46	100	48	56	32	44.44	64	24	40	24	55.99	100	24	86	64
36.67	48	24	44	24	44.64	100	28	40	32	56.25	100	32	72	40
36.86	86	28	48	40	44.68	86	28	64	44	56.31	86	24	44	28
37.04	100	24	64	72	44.79	100	40	86	48	57.14	100	28	64	40
37.33	100	32	86	72	45.00	72	28	56	32	57.30	100	24	44	32
37.40	72	28	64	44	45.45	100	32	64	44	57.33	86	24	64	40
37.50	100	48	72	40	45.46	100	28	56	44	58.33	100	24	56	40
37.63	86	32	56	40	45.61	86	24	56	44	58.44	100	28	72	44
37.88	100	24	40	44	45.72	64	24	48	28	58.64	86	24	72	44
38.10	64	24	40	28	45.84	100	24	44	40	59.53	100	24	40	28
38.18	72	24	56	44	45.92	100	28	72	56	60.00	72	24	64	32

Lead of Helix for Given Helix Angle Relative to Axis, When Diameter = 1

Deg.	0'	6'	12'	18'	24'	30'	36'	42'	48'	54'	60'
0	Infin.	1800.001	899.997	599.994	449.993	359.992	299.990	257.130	224.986	199.983	179.982
1	179.982	163.616	149.978	138.438	128.545	119.973	112.471	105.851	99.967	94.702	89.964
2	89.964	85.676	81.778	78.219	74.956	71.954	69.183	66.617	64.235	62.016	59.945
3	59.945	58.008	56.191	54.485	52.879	51.365	49.934	48.581	47.299	46.082	44.927
4	44.927	43.827	42.780	41.782	40.829	39.918	39.046	38.212	37.412	36.645	35.909
5	35.909	35.201	34.520	33.866	33.235	32.627	32.040	31.475	30.928	30.400	29.890
6	29.890	29.397	28.919	28.456	28.008	27.573	27.152	26.743	26.346	25.961	25.586
7	25.586	25.222	24.868	24.524	24.189	23.863	23.545	23.236	22.934	22.640	22.354
8	22.354	22.074	21.801	21.535	21.275	21.021	20.773	20.530	20.293	20.062	19.835
9	19.835	19.614	19.397	19.185	18.977	18.773	18.574	18.379	18.188	18.000	17.817
10	17.817	17.637	17.460	17.287	17.117	16.950	16.787	16.626	16.469	16.314	16.162
11	16.162	16.013	15.866	15.722	15.581	15.441	15.305	15.170	15.038	14.908	14.780
12	14.780	14.654	14.530	14.409	14.289	14.171	14.055	13.940	13.828	13.717	13.608
13	13.608	13.500	13.394	13.290	13.187	13.086	12.986	12.887	12.790	12.695	12.600
14	12.600	12.507	12.415	12.325	12.237	12.148	12.061	11.975	11.890	11.807	11.725
15	11.725	11.643	11.563	11.484	11.405	11.328	11.252	11.177	11.102	11.029	10.956
16	10.956	10.884	10.813	10.743	10.674	10.606	10.538	10.471	10.405	10.340	10.276
17	10.276	10.212	10.149	10.086	10.025	9.964	9.904	9.844	9.785	9.727	9.669
18	9.669	9.612	9.555	9.499	9.444	9.389	9.335	9.281	9.228	9.176	9.124
19	9.124	9.072	9.021	8.971	8.921	8.872	8.823	8.774	8.726	8.679	8.631
20	8.631	8.585	8.539	8.493	8.447	8.403	8.358	8.314	8.270	8.227	8.184
21	8.184	8.142	8.099	8.058	8.016	7.975	7.935	7.894	7.855	7.815	7.776
22	7.776	7.737	7.698	7.660	7.622	7.584	7.547	7.510	7.474	7.437	7.401
23	7.401	7.365	7.330	7.295	7.260	7.225	7.191	7.157	7.123	7.089	7.056
24	7.056	7.023	6.990	6.958	6.926	6.894	6.862	6.830	6.799	6.768	6.737
25	6.737	6.707	6.676	6.646	6.617	6.586	6.557	6.528	6.499	6.470	6.441
26	6.441	6.413	6.385	6.357	6.329	6.300	6.274	6.246	6.219	6.192	6.166
27	6.166	6.139	6.113	6.087	6.061	6.035	6.009	5.984	5.959	5.933	5.908
28	5.908	5.884	5.859	5.835	5.810	5.786	5.762	5.738	5.715	5.691	5.668
29	5.668	5.644	5.621	5.598	5.575	5.553	5.530	5.508	5.486	5.463	5.441

Lead of Helix for Given Helix Angle Relative to Axis, When Diameter = 1 (Continued)

Deg.	0'	6'	12'	18'	24'	30'	36'	42'	48'	54'	60'
30	5.441	5.420	5.398	5.376	5.355	5.333	5.312	5.291	5.270	5.249	5.228
31	5.228	5.208	5.187	5.167	5.147	5.127	5.107	5.087	5.067	5.047	5.028
32	5.028	5.008	4.989	4.969	4.950	4.931	4.912	4.894	4.875	4.856	4.838
33	4.838	4.819	4.801	4.783	4.764	4.746	4.728	4.711	4.693	4.675	4.658
34	4.658	4.640	4.623	4.605	4.588	4.571	4.554	4.537	4.520	4.503	4.487
35	4.487	4.470	4.453	4.437	4.421	4.404	4.388	4.372	4.356	4.340	4.324
36	4.324	4.308	4.292	4.277	4.261	4.246	4.230	4.215	4.199	4.184	4.169
37	4.169	4.154	4.139	4.124	4.109	4.094	4.079	4.065	4.050	4.036	4.021
38	4.021	4.007	3.992	3.978	3.964	3.950	3.935	3.921	3.907	3.893	3.880
39	3.880	3.866	3.852	3.838	3.825	3.811	3.798	3.784	3.771	3.757	3.744
40	3.744	3.731	3.718	3.704	3.691	3.678	3.665	3.652	3.640	3.627	3.614
41	3.614	3.601	3.589	3.576	3.563	3.551	3.538	3.526	3.514	3.501	3.489
42	3.489	3.477	3.465	3.453	3.440	3.428	3.416	3.405	3.393	3.381	3.369
43	3.369	3.358	3.346	3.334	3.322	3.311	3.299	3.287	3.276	3.265	3.253
44	3.253	3.242	3.231	3.219	3.208	3.197	3.186	3.175	3.164	3.153	3.142
45	3.142	3.131	3.120	3.109	3.098	3.087	3.076	3.066	3.055	3.044	3.034
46	3.034	3.023	3.013	3.002	2.992	2.981	2.971	2.960	2.950	2.940	2.930
47	2.930	2.919	2.909	2.899	2.889	2.879	2.869	2.859	2.849	2.839	2.829
48	2.829	2.819	2.809	2.799	2.789	2.779	2.770	2.760	2.750	2.741	2.731
49	2.731	2.721	2.712	2.702	2.693	2.683	2.674	2.664	2.655	2.645	2.636
50	2.636	2.627	2.617	2.608	2.599	2.590	2.581	2.571	2.562	2.553	2.544
51	2.544	2.535	2.526	2.517	2.508	2.499	2.490	2.481	2.472	2.463	2.454
52	2.454	2.446	2.437	2.428	2.419	2.411	2.402	2.393	2.385	2.376	2.367
53	2.367	2.359	2.350	2.342	2.333	2.325	2.316	2.308	2.299	2.291	2.282
54	2.282	2.274	2.266	2.257	2.249	2.241	2.233	2.224	2.216	2.208	2.200
55	2.200	2.192	2.183	2.175	2.167	2.159	2.151	2.143	2.135	2.127	2.119
56	2.119	2.111	2.103	2.095	2.087	2.079	2.072	2.064	2.056	2.048	2.040
57	2.040	2.032	2.025	2.017	2.009	2.001	1.994	1.986	1.978	1.971	1.963
58	1.963	1.955	1.948	1.940	1.933	1.925	1.918	1.910	1.903	1.895	1.888
59	1.888	1.880	1.873	1.865	1.858	1.851	1.843	1.836	1.828	1.821	1.814

Lead of Helix for Given Helix Angle Relative to Axis, When Diameter = 1 (Continued)

Deg.	0'	6'	12'	18'	24'	30'	36'	42'	48'	54'	60'
60	1.814	1.806	1.799	1.792	1.785	1.777	1.770	1.763	1.756	1.749	1.741
61	1.741	1.734	1.727	1.720	1.713	1.706	1.699	1.692	1.685	1.677	1.670
62	1.670	1.663	1.656	1.649	1.642	1.635	1.628	1.621	1.615	1.608	1.601
63	1.601	1.594	1.587	1.580	1.573	1.566	1.559	1.553	1.546	1.539	1.532
64	1.532	1.525	1.519	1.512	1.505	1.498	1.492	1.485	1.478	1.472	1.465
65	1.465	1.458	1.452	1.445	1.438	1.432	1.425	1.418	1.412	1.405	1.399
66	1.399	1.392	1.386	1.379	1.372	1.366	1.359	1.353	1.346	1.340	1.334
67	1.334	1.327	1.321	1.314	1.308	1.301	1.295	1.288	1.282	1.276	1.269
68	1.269	1.263	1.257	1.250	1.244	1.237	1.231	1.225	1.219	1.212	1.206
69	1.206	1.200	1.193	1.187	1.181	1.175	1.168	1.162	1.156	1.150	1.143
70	1.143	1.137	1.131	1.125	1.119	1.112	1.106	1.100	1.094	1.088	1.082
71	1.082	1.076	1.069	1.063	1.057	1.051	1.045	1.039	1.033	1.027	1.021
72	1.021	1.015	1.009	1.003	0.997	0.991	0.985	0.978	0.972	0.966	0.960
73	0.960	0.954	0.948	0.943	0.937	0.931	0.925	0.919	0.913	0.907	0.901
74	0.901	0.895	0.889	0.883	0.877	0.871	0.865	0.859	0.854	0.848	0.842
75	0.842	0.836	0.830	0.824	0.818	0.812	0.807	0.801	0.795	0.789	0.783
76	0.783	0.777	0.772	0.766	0.760	0.754	0.748	0.743	0.737	0.731	0.725
77	0.725	0.720	0.714	0.708	0.702	0.696	0.691	0.685	0.679	0.673	0.668
78	0.668	0.662	0.656	0.651	0.645	0.639	0.633	0.628	0.622	0.616	0.611
79	0.611	0.605	0.599	0.594	0.588	0.582	0.577	0.571	0.565	0.560	0.554
80	0.554	0.548	0.543	0.537	0.531	0.526	0.520	0.514	0.509	0.503	0.498
81	0.498	0.492	0.486	0.481	0.475	0.469	0.464	0.458	0.453	0.447	0.441
82	0.441	0.436	0.430	0.425	0.419	0.414	0.408	0.402	0.397	0.391	0.386
83	0.386	0.380	0.375	0.369	0.363	0.358	0.352	0.347	0.341	0.336	0.330
84	0.330	0.325	0.319	0.314	0.308	0.302	0.297	0.291	0.286	0.280	0.275
85	0.275	0.269	0.264	0.258	0.253	0.247	0.242	0.236	0.231	0.225	0.220
86	0.220	0.214	0.209	0.203	0.198	0.192	0.187	0.181	0.176	0.170	0.165
87	0.165	0.159	0.154	0.148	0.143	0.137	0.132	0.126	0.121	0.115	0.110
88	0.110	0.104	0.099	0.093	0.088	0.082	0.077	0.071	0.066	0.060	0.055
89	0.055	0.049	0.044	0.038	0.033	0.027	0.022	0.016	0.011	0.005	0.000

Leads, Change Gears and Angles for Helical Milling

Lead of Helix, Inches	Change Gears				Diameter of Work, Inches											
	Gear on Work m	First Gear on Stud	Second Gear on Stud	Gear on Screw	1/8	1/4	3/8	1/2	5/8	3/4	7/8	1	1 1/4	1 1/2		
					Approximate Angles for Milling Machine Table											
0.67	24	86	24	100	30 3/4		
0.78	24	86	28	100	26	44 1/2		
0.89	24	86	32	100	23 1/2	41		
1.12	24	86	40	100	19	34 1/2		
1.34	24	86	48	100	16	30 1/4	41 1/2		
1.46	24	64	28	72	14 3/4	28	38 1/2		
1.56	24	86	56	100	13 3/4	26 1/2	37		
1.67	24	64	32	72	12 3/4	25	34 3/4	43 1/4		
1.94	32	64	28	72	11 1/4	21 3/4	31	39	45		
2.08	24	64	40	72	10 1/4	20 1/2	29 1/2	37	43 1/4		
2.22	32	56	28	72	9 3/4	19 1/4	27 1/2	35	41 1/4		
2.50	24	64	48	72	8 3/4	17	25	32	38	43 3/4		
2.78	40	56	28	72	8	15 1/2	23	29 1/2	35 1/4	40 1/2	44 3/4		
2.92	24	64	56	72	7 1/2	15	21 3/4	28 1/4	34	39	43 1/4		
3.24	40	48	28	72	6 3/4	13 3/4	19 3/4	25 3/4	31 1/4	36	40 1/2	44 1/4		
3.70	40	48	32	72	6	11 3/4	17 1/2	23	28	32 1/2	36 1/2	40 1/2		
3.89	56	48	24	72	5 1/2	11 1/4	16 3/4	22	26 3/4	31 1/4	35 1/4	39		
4.17	40	72	48	64	5 1/4	10 3/4	15 3/4	20 1/2	25 1/4	29 1/2	33 1/2	37	43 1/4	...		
4.46	48	40	32	86	4 3/4	9 3/4	14 3/4	19 1/4	23 3/4	27 3/4	31 1/2	35	41 1/2	...		
4.86	40	64	56	72	4 1/2	9	13 1/2	17 3/4	22	25 3/4	29 1/2	33	39	44 1/4		
5.33	48	40	32	72	4	8 1/4	12 1/4	16 1/2	20 1/4	23 1/4	27 1/4	30 1/2	36 1/2	41 1/2		
5.44	56	40	28	72	4	8	12	16	20	23 1/2	26 3/4	30	36	41		
6.12	56	40	28	64	3 3/2	7 1/4	11	14 1/2	17 3/4	21	24 1/4	27	33	37 3/4		
6.22	56	40	32	72	3 3/4	7	10 3/4	14 1/4	17 1/2	20 3/4	23 3/4	26 3/4	32 1/2	37 1/4		
6.48	56	48	40	72	3 1/4	6 3/4	10 1/4	13 1/2	16 3/4	20	23	25 1/4	31 1/2	36 1/4		
6.67	64	48	28	56	3 1/4	6 1/2	10	13 1/4	16 1/2	19 1/2	22 1/2	25 1/4	30 3/4	35 1/4		
7.29	56	48	40	64	3	6 1/4	9 1/4	12 1/4	15	18	20 3/2	23 1/2	28 1/2	33		
7.41	64	48	40	72	3	6	9	12	14 3/4	17 3/4	20 3/4	23 1/4	28 1/4	32 1/2		
7.62	64	48	32	56	2 3/4	5 3/4	8 3/4	11 1/2	14 1/2	17 1/4	19 1/4	22 1/4	27 1/2	32		
8.33	48	32	40	72	2 1/2	5 1/4	8	10 1/2	13 1/4	15 1/4	18 1/4	20 1/2	25 1/2	29 1/2		
8.95	86	48	28	56	2 1/2	5	7 1/2	10	12 1/2	14 1/4	17	19 1/4	24	28		
9.33	56	40	48	72	2 1/4	4 3/4	7 1/4	9 1/2	11 3/4	14	16 1/4	18 1/2	23	27		
9.52	64	48	40	56	2 1/4	4 1/2	7	9 1/4	11 1/2	13 3/4	16	18 1/4	22 1/2	26 1/2		
10.29	72	40	32	56	2	4 1/4	6 1/2	8 1/2	10 1/4	12 1/4	15	17 1/4	21	24 1/4		
10.37	64	48	56	72	2	4 1/4	6 1/2	8 1/2	10 1/2	12 1/2	14 3/4	17	20 3/4	24 1/2		
10.50	48	40	56	64	2	4 1/4	6 1/4	8 1/2	10 1/2	12 1/2	14 1/2	16 1/2	20 1/2	24 1/4		
10.67	64	40	48	72	2	4	6 1/4	8 1/4	10 1/4	12 1/4	14 1/4	16 1/2	20 1/4	24		
10.94	56	32	40	64	2	4	6	8 1/4	10 1/4	12	14	16 1/4	20	23 1/2		
11.11	64	32	40	72	2	4	6	8	10	11 3/4	13 3/4	16	19 3/4	23		
11.66	56	32	48	72	1 3/4	3 3/4	5 3/4	7 1/2	9 1/2	11 1/4	13 1/4	15 3/4	18 3/4	22		
12.00	72	40	32	48	1 3/4	3 3/4	5 1/2	7 1/4	9 1/4	11	12 3/4	15	18 1/4	21 1/2		
13.12	56	32	48	64	1 1/2	3 1/2	5 1/4	6 3/4	8 1/4	10 1/4	11 3/4	13 1/2	16 1/4	20		
13.33	56	28	48	72	1 1/2	3 1/4	5	6 1/2	8 1/4	10	11 1/2	13 1/4	16 1/2	19 1/2		
13.71	64	40	48	56	1 1/2	3 1/4	4 3/4	6 1/2	8	9 3/4	11 1/4	13	16	19		
15.24	64	28	48	72	1 1/2	3	4 1/2	5 3/4	7 1/4	8 3/4	10 1/4	11 3/4	14 1/2	17 1/4		
15.56	64	32	56	72	1 1/4	2 3/4	4 1/4	5 3/4	7 1/4	8 3/4	10	11 1/2	14 1/4	17		
15.75	56	64	72	40	1 1/4	2 3/4	4 1/4	5 1/2	7	8 1/2	9 3/4	11 1/4	14	16 3/4		
16.87	72	32	48	64	1 1/4	2 1/2	4	5 1/4	6 3/4	7 3/4	9 1/4	10 1/2	13 1/4	15 3/4		
17.14	64	32	48	56	1 1/4	2 1/2	4	5 1/4	6 1/2	7 3/4	9	10 1/4	13	15 1/2		
18.75	72	32	40	48	1	2 1/4	3 1/2	4 1/4	5 1/4	6 1/4	7 1/4	8 1/4	9 1/2	12		
19.29	72	32	48	56	1	2 1/4	3 1/2	4 1/2	5 3/4	7	8	9 1/4	11 1/2	13 3/4		
19.59	64	28	48	56	1	2 1/4	3 1/4	4 1/2	5 3/4	6 3/4	8	9 1/4	11 1/2	13 1/2		
19.69	72	32	56	64	1	2 1/4	3 1/4	4 1/2	5 3/4	6 3/4	8	9	11 1/2	13 1/2		
21.43	72	24	40	56	1	2	3 1/4	4 1/4	5 1/4	6 1/4	7 1/2	8 1/2	10 1/2	12 1/2		
22.50	72	28	56	64	1	2	3	4	5	6	7	8	10	12		
23.33	64	32	56	48	1	2	3	4	5	5 1/2	6 1/2	7 1/4	9 1/4	11 1/2		
26.25	72	24	56	64	1	1 3/4	2 3/4	3 1/2	4 1/4	5	6	7	8 1/2	10 1/4		
26.67	64	28	56	48	3/4	1 3/4	2 3/4	3 1/2	4 1/4	5	6	6 3/4	8 1/2	10		
28.00	64	32	56	40	3/4	1 3/4	2 1/2	3 1/4	4	4 3/4	5 1/4	6 1/2	8	9 1/2		
30.86	72	28	48	40	3/4	1 1/2	2 1/4	3	3 3/4	4 1/2	5	5 3/4	7 1/4	8 3/4		

Leads, Change Gears and Angles for Helical Milling

Lead of Helix, Inches	Change Gears				Diameter of Work, Inches									
	Gear on Worm	First Gear on Stud	Second Gear on Stud	Gear on Screw	1 3/4	2	2 1/4	2 1/2	2 3/4	3	3 1/4	3 1/2	3 3/4	4
					Approximate Angles for Milling Machine Table									
6.12	56	40	28	64	42
6.22	56	40	32	72	41 1/2
6.48	56	48	40	72	40 1/4	44 1/4
6.67	64	48	28	56	39 1/2	43 1/2
7.29	56	48	40	64	37	41	44 1/2
7.41	64	48	40	72	36 1/2	40 1/4	43 3/4
7.62	64	48	32	56	36	39 1/2	43
8.33	48	32	40	72	33 1/2	37	40 1/2	43 1/2
8.95	86	48	28	56	31 1/4	35 1/4	38 1/2	41 1/4	44
9.33	56	40	48	72	30 1/2	34	37 1/4	40 1/4	43
9.52	64	48	40	56	30	33 1/2	36 1/2	39 1/2	42 1/4	45
10.29	72	40	32	56	28 1/4	31 1/2	34 1/2	37 1/2	40	42 1/2	45
10.37	64	48	56	72	28	31 1/4	34 1/4	37 1/4	39 1/4	42 1/4	44 1/4
10.50	48	40	56	64	27 1/4	31	34	36 1/4	39 1/2	42	44 1/4
10.67	64	40	48	72	27 1/4	30 1/2	33 1/2	36 1/2	39	41 1/4	43 3/4
10.94	56	32	40	64	26 1/4	30	33	35 1/4	38 1/4	40 1/4	43
11.11	64	32	40	72	26 1/2	29 1/2	32 1/2	35 1/4	38	40 1/4	42 1/2	44 3/4
11.66	56	32	48	72	25 1/4	28 1/2	31 1/4	34	36 1/2	39	41 1/4	43 1/2
12.00	72	40	32	48	24 3/4	27 3/4	30 1/2	33 1/4	35 3/4	38	40 1/4	42 1/2	44 3/4	...
13.12	56	32	48	64	22 3/4	25 3/4	28 1/4	31	33 1/4	35 3/4	37 3/4	40	42	43 3/4
13.33	56	28	48	72	22 1/2	25 1/2	28	30 1/2	33	35 1/4	37 1/2	39 1/2	41 1/2	43 1/2
13.71	64	40	48	56	22	24 1/4	27 1/4	30	32 1/4	34 1/2	36 1/2	38 3/4	40 3/4	42 1/2
15.24	64	28	48	72	20	22 1/2	25	27 1/4	29 1/2	31 3/4	34	35 3/4	37 3/4	39 1/2
15.56	64	32	56	72	19 1/2	22	24 1/2	27	29	31 1/4	33 1/4	35 1/4	37	39
15.75	56	64	72	40	19 1/4	21 3/4	24 1/4	26 1/2	28 1/2	31	33	35	36 3/4	38 1/2
16.87	72	32	48	64	18 1/4	20 1/2	22 3/4	25	27	29 1/4	31 1/4	33 1/4	35	36 1/2
17.14	64	32	48	56	17 3/4	20 1/4	22 1/4	24 1/4	26 1/4	29	30 3/4	32 1/4	34 1/2	36
18.75	72	32	40	48	16 1/4	18 1/2	20 3/4	22 3/4	25	26 3/4	28 1/2	30 1/4	32	33 3/4
19.29	72	32	48	56	16	18 1/4	20 1/4	22 1/4	24	26	28	29 3/4	31 1/2	33
19.59	64	28	48	56	15 3/4	18	20	22	23 3/4	25 3/4	27 1/2	29 1/4	31	32 3/4
19.69	72	32	56	64	15 1/4	17 3/4	20	21 3/4	23 3/4	25 1/2	27 1/2	29 1/4	31	32 1/2
21.43	72	24	40	56	14 1/2	16 1/2	18 1/2	20 1/4	22	23 3/4	25 1/2	27 1/4	29	30 1/4
22.50	72	28	56	64	13 3/4	15 3/4	17 1/2	19 1/4	21	22 3/4	24 1/2	26	27 3/4	29 1/4
23.33	64	32	56	48	13 1/4	15 1/4	17	18 3/4	20 1/4	22	23 1/2	25 1/4	27	28 1/4
26.25	72	24	56	64	12	13 1/2	15	16 1/4	18 1/4	19 3/4	21 1/4	22 3/4	24 1/4	25 1/2
26.67	64	28	56	48	11 3/4	13 1/4	14 3/4	16 1/2	18	19 1/2	21	22 1/4	23 3/4	25 1/4
28.00	64	32	56	40	11 1/4	12 3/4	14 1/4	15 3/4	17 1/4	18 3/4	20	21 1/2	22 1/4	24
30.86	72	28	48	40	10	11 1/2	13	14 1/4	15 1/2	17	18 1/2	19 1/2	21	22
31.50	72	32	56	40	10	11 1/4	12 3/4	14	15 1/4	16 1/2	18	19 1/4	20 1/2	21 3/4
36.00	72	32	64	40	8 3/4	10	11	12 1/4	13 1/4	14 3/4	16	17	18 1/4	19 1/4
41.14	72	28	64	40	7 3/4	8 3/4	9 3/4	10 3/4	11 3/4	13	14	15	16	17
45.00	72	28	56	32	7	8	9	10	11	11 3/4	12 3/4	13 3/4	14 1/4	15 1/2
48.00	72	24	64	40	6 1/2	7 1/2	8 1/2	9 1/4	10 1/4	11 1/4	12	13	13 3/4	14 1/2
51.43	72	28	64	32	6	7	7 3/4	8 3/4	9 1/2	10 1/2	11 1/2	12	12 3/4	13 1/2
60.00	72	24	64	32	5 1/4	6	6 3/4	7 1/2	8 1/4	9	9 1/2	10 1/4	11	11 3/4
68.57	72	24	64	28	4 3/4	5 1/4	5 3/4	6 1/2	7 1/4	8	8 1/2	9	9 3/4	10 1/4

Helix Angle for Given Lead and Diameter.—The table on this and the preceding page gives helix angles (relative to axis) equivalent to a range of leads and diameters. The expression "Diameter of Work" at the top of the table might mean pitch diameter or outside diameter, depending upon the class of work. Assume, for example, that a plain milling cutter 4 inches in diameter is to have helical teeth and a helix angle of about 25 degrees is desired. The table shows that this angle will be obtained approximately by using change-gears that will give a lead of 26.67 inches. As the outside diameter of the cutter is 4 inches,

the helix angle of $25\frac{1}{4}$ degrees is at the top of the teeth. The angles listed for different diameters are used in setting the table of a milling machine. In milling a right-hand helix (or cutter teeth that turn to the right as seen from the end of the cutter), swivel the right-hand end of the machine table toward the rear, and, inversely, for a left-hand helix, swivel the left-hand end of the table toward the rear. The angles in the table are based upon the following formula:

$$\cot \text{ helix angle relative to axis} = \frac{\text{lead of helix}}{3.1416 \times \text{diameter}}$$

Lead of Helix for Given Angle.—The lead of a helix or “spiral” for given angles measured with the axis of the work is given in the table, starting on page 1978, for a diameter of 1. For other diameters, lead equals the value found in the table multiplied by the given diameter. Suppose the angle is 55 degrees, and the diameter 5 inches; what would be the lead? By referring to the table starting on page 1978, it is found that the lead for a diameter of 1 and an angle of 55 degrees 0 minutes equals 2.200. Multiply this value by 5; $5 \times 2.200 = 11$ inches, which is the required lead. If the lead and diameter are given, and the angle is wanted, divide the given lead by the given diameter, thus obtaining the lead for a diameter equal to 1; then find the angle corresponding to this lead in the table. If the lead and angle are given, and the diameter is wanted, divide the lead by the value in the table for the angle.

Helix Angle for Given Lead and Pitch Radius.—To determine the helix angle for a helical gear, knowing the pitch radius and the lead, use the formula:

$$\tan \psi = 2\pi R/L$$

where ψ = helix angle

R = pitch radius of gear, and

L = lead of tooth

Example:

$$R = 3.000, L = 21.000, \tan \psi = (2 \times 3.1416 \times 3.000)/21.000 = 0.89760$$

$$\therefore \psi = 41.911 \text{ degrees}$$

Helix Angle and Lead, Given Normal DP and Numbers of Teeth.—When N_1 = number of teeth in pinion, N_2 = number of teeth in gear, P_n = normal diametral pitch, C = center distance, ψ = helix angle, L_1 = lead of pinion, and L_2 = lead of gear, then:

$$\cos \psi = \frac{N_1 + N_2}{2P_n C}, \quad L_1 = \frac{\pi N_1}{P_n \sin \psi}, \quad L_2 = \frac{\pi N_2}{P_n \sin \psi}$$

$$P_n = 6, \quad N_1 = 18, \quad N_2 = 30, \quad C = 4.500$$

$$\cos \psi = \frac{18 + 30}{2 \times 6 \times 4.5} = 0.88889, \therefore \psi = 27.266^\circ, \text{ and } \sin \psi = 0.45812$$

$$L_1 = \frac{3.1416 \times 18}{6 \times 0.45812} = 20.5728, \text{ and } L_2 = \frac{3.1416 \times 30}{6 \times 0.45812} = 34.2880$$

Lead of Tooth Given Pitch Radius and Helix Angle.—To determine the lead of the tooth for a helical gear, given the helix angle and the pitch radius, the formula becomes:
 $L = 2\pi R/\tan \psi$.

$$\psi = 22.5^\circ, \quad \therefore \tan \psi = 0.41421, \quad R = 2.500.$$

$$L = \frac{2 \times 3.1416 \times 2.500}{0.41421} = 37.9228$$

SIMPLE, COMPOUND, DIFFERENTIAL, AND BLOCK INDEXING

Milling Machine Indexing.—Positioning a workpiece at a precise angle or interval of rotation for a machining operation is called indexing. A dividing head is a milling machine attachment that provides this fine control of rotational positioning through a combination of a crank-operated worm and worm gear, and one or more indexing plates with several circles of evenly spaced holes to measure partial turns of the worm crank. The indexing crank carries a movable indexing pin that can be inserted into and withdrawn from any of the holes in a given circle with an adjustment provided for changing the circle that the indexing pin tracks.

Hole Circles.—The Brown & Sharpe dividing head has three standard indexing plates, each with six circles of holes as listed in the table below.

Numbers of Holes in Brown & Sharpe Standard Indexing Plates

Plate Number	Numbers of Holes					
1	15	16	17	18	19	20
2	21	23	27	29	31	33
3	37	39	41	43	47	49

Dividing heads of Cincinnati Milling Machine design have two-sided, standard, and high-number plates with the numbers of holes shown in the following table.

Numbers of Holes in Cincinnati Milling Machine Standard Indexing Plates

Side	Standard Plate										
1	24	25	28	30	34	37	38	39	41	42	43
2	46	47	49	51	53	54	57	58	59	62	66
	High-Number Plates										
A	30	48	69	91	99	117	129	147	171	177	189
B	36	67	81	97	111	127	141	157	169	183	199
C	34	46	79	93	109	123	139	153	167	181	197
D	32	44	77	89	107	121	137	151	163	179	193
E	26	42	73	87	103	119	133	149	161	175	191
F	28	38	71	83	101	113	131	143	159	173	187

Some dividing heads provide for *Direct Indexing* through the attachment of a special indexing plate directly to the main spindle where a separate indexing pin engages indexing holes in the plate. The worm is disengaged from the worm gear during this quick method of indexing, which is mostly used for common, small-numbered divisions such as six, used in machining hexagonal forms for bolt heads and nuts, for instance.

Simple Indexing.—Also called *Plain Indexing* or *Indirect Indexing*, simple indexing is based on the ratio between the worm and the worm gear, which is usually, but not always, 40:1. All the tables in this section are based on a 40:1 gear ratio, except for [Table 8](#) on page 2024 that gives indexing movements for dividing heads utilizing a 60:1 gear ratio.

The number of turns of the indexing crank needed for each indexing movement to produce a specified number of evenly spaced divisions is equal to the number of turns of the crank that produce exactly one full turn of the main spindle, divided by the specified number of divisions required for the workpiece. The accompanying tables in this section provide data for the indexing movements to meet most division requirements, and include the simple indexing movements along with the more complex movements for divisions that are not available through simple indexing. The fractional entries in the tables are deliberately not reduced to lowest terms. Thus, the numerator represents the number of holes to be moved on the circle of holes specified by the denominator.

Setting up for an indexing job includes setting the sector arms to the fractional part of a turn required for each indexing movement to avoid the need to count holes each time. The current location of the indexing pin in the circle of holes to be used is always hole zero when counting the number of holes to be moved. The wormshaft hub carrying the dividing plate may also carry one or two sets of sector arms, each of which can be used to define two arcs of holes. As shown at the right in the drawing of a typical dividing head at the top of the table *Simple and Differential Indexing with Browne & Sharpe Indexing Plates* on page 2012, these sector arms can make up an inner arc, A, and an outer arc, B. The inner arc is used most often, but some indexing movements require the use of the outer arc.

Example: With a worm/worm gear ratio of 40:1 making 35 divisions requires each indexing movement to be $40 \div 35 = 1 \frac{1}{7}$ turns: one full turn of the indexing crank plus one-seventh of a full turn more. A full turn is easily achieved using any circle of holes, but to continue the indexing movement to completion for this example requires a circle in which the number of holes is evenly divisible by 7. The Brown & Sharpe dividing head has a 21-hole circle on plate 2 and a 49-hole circle on plate 3. Either circle could be used because $3/21$ and $7/49$ both equal $1/7$ th. The Cincinnati dividing head standard plate has a 28-hole circle on the first side and a 49-hole circle on the second side and again, either $4/28$ or $7/49$ could be used for the fractional part of a turn needed for 35 divisions. In selecting among equivalent indexing solutions, the one with the smallest number of holes in the fractional part of a turn is generally preferred (except that if an indexing plate with an alternate solution is already mounted on the dividing head, the alternate should be used to avoid switching indexing plates).

Compound Indexing.—Compound indexing is used to obtain divisions that are not available by simple indexing. Two simple indexing movements are used with different circles of holes on an indexing plate that is not bolted to the dividing head frame so that it is free to rotate on the worm shaft. A second, stationary indexing pin arrangement is clamped or otherwise fixed to the frame of the dividing head to hold the indexing plate in position except during the second portion of the compound indexing movement. If available, a double set of low-profile sector arms would improve the ease and reliability of this method. Sector arms for the innermost circle of an indexing movement should not reach as far as the outermost circle of the movement, and sector arms for the outermost circle should be full length. Positioning the outermost circle sector arms may have to wait until the indexing pin on the innermost circle is withdrawn, and may sometimes coincide with the position of that pin. The indexing pin on the crank is set to track the innermost of the two circles in the compound movement and the stationary indexing pin is set to track the outermost circle. Some divisions are only available using adjacent circles, so the intercircle spacing may become a constraining factor in the design or evaluation of a stationary pin arrangement.

The first part of the indexing movement is performed as in simple indexing by withdrawing the indexing pin on the crank arm from its hole in the indexing plate, rotating the crank to its next position, and reinserting the indexing pin in the new hole. For the second part of the movement, the stationary indexing pin is released from its hole in the indexing plate, and with the crank indexing pin seated in its hole, the crank is used to turn the crank arm and indexing plate together to the next position for reinserting the stationary pin into its new hole.

There are two possibilities for the separate movements in compound indexing: they may both be in the same direction of rotation, referred to as *positive compounding* and indicated in the table by a plus (+) sign between the two indexing movements, or they may be in opposite directions of rotation, referred to as *negative compounding* and indicated in the table by a minus (–) sign between the two indexing movements. In positive compounding, it does not matter whether the rotation is clockwise or counterclockwise, as long as it is the same throughout the job. In negative compounding, there will be one clockwise movement and one counterclockwise movement for each unit of the division. The mathematical difference is in whether the two fractional turns are to be added together or whether one is to

be subtracted from the other. Operationally, this difference is important because of the backlash, or free play, between the worm and the worm gear of the dividing head. In positive compounding, this play is always taken up because the worm is turned continually in the same direction. In negative compounding, however, the direction of each turn is always opposite that of the previous turn, requiring each portion of each division to be started by backing off a few holes to allow the play to be taken up before the movement to the next position begins.

The Tables 1a and 1b, *Simple and Compound Indexing with Brown & Sharpe Plates*, gives indexing movements for all divisions up to and including 250 with plain dividing heads of the Brown & Sharpe design. All the simple indexing movements, and many of the compound indexing movements, are exact for the divisions they provide. There remains a substantial number of divisions for which the indexing movements are approximate. For these divisions, the indexing movements shown come very close to the target number, but the price of getting close is increased length and complexity of the indexing movements. The table shows all divisions that can be obtained through simple indexing and all divisions for which exact compound indexing movements are available. Approximate movements are only used when it is necessary to obtain a division that would otherwise not be available. The approximate indexing movements usually involve multiple revolutions of the workpiece, with successive revolutions filling in spaces left during earlier turns.

Table 1a. Simple and Compound Indexing with Brown & Sharpe Plates

Number of Divisions	Whole Turns	Fractions of a Turn	Number of Divisions	Whole Turns	Fractions of a Turn	Number of Divisions	Whole Turns	Fractions of a Turn
2	20	...	15	2	26/39	33	1	7/33
3	13	5/15	16	2	8/16	34	1	3/17
3	13	7/21	17	2	6/17	35	1	3/21
3	13	13/39	18	2	4/18	35	1	7/49
4	10	...	18	2	6/27	36	1	2/18
5	8	...	19	2	2/19	36	1	3/27
6	6	10/15	20	2	...	37	1	3/37
6	6	14/21	21	1	19/21	38	1	1/19
6	6	26/39	22	1	27/33	39	1	1/39
7	5	15/21	23	1	17/23	40	1	...
8	5	...	24	1	10/15	41	...	40/41
9	4	8/18	24	1	14/21	42	...	20/21
9	4	12/27	24	1	26/39	43	...	40/43
10	4	...	25	1	9/15	44	...	30/33
11	3	21/33	26	1	21/39	45	...	16/18
12	3	5/15	27	1	13/27	45	...	24/27
12	3	7/21	28	1	9/21	46	...	20/23
12	3	13/39	29	1	11/29	47	...	40/47
13	3	3/39	30	1	5/15	48	...	15/18
14	2	18/21	30	1	7/21	49	...	40/49
14	2	42/49	30	1	13/39	50	...	12/15
15	2	10/15	31	1	9/31			
15	2	14/21	32	1	4/16			

Table 1b. Simple and Compound Indexing with Brown & Sharpe Plates

Target Divisions	Indexing Movements	Workpiece Revolutions	Precise Number of Divisions	Diameter at Which Error = 0.001	Target Divisions	Indexing Movements	Workpiece Revolutions	Precise Number of Divisions	Diameter at Which Error = 0.001
51	10/15 + 2/17	1	51.00000	Exact	57	5/15 + 7/19	1	57.00000	Exact
51 ^a	7 ⁴ / ₁₇ + 37/49	11	51.00005	322.55	57 ^a	4 ⁶ / ₁₇ + 3/49	7	56.99991	205.26
52	30/39	1	52.00000	Exact	58	20/29	1	58.00000	Exact
53	26/29 + 19/31	2	52.99926	22.89	59	18/37 + 9/47	1	58.99915	22.14
53	14/43 + 4 ⁵ / ₄₇	7	52.99991	180.13	59	4 ² / ₄₃ + 1/47	6	59.00012	154.39
53 ^a	5 ⁴ / ₄₇ + 43/49	9	53.00006	263.90	59 ^a	7 ⁶ / ₄₇ + 12/49	11	58.99971	64.51
54	20/27	1	54.00000	Exact	59	5 ³ / ₄₇ + 3 ² / ₄₉	13	58.99994	300.09
55	24/33	1	55.00000	Exact	60	10/15	1	60.00000	Exact
56	15/21	1	56.00000	Exact	60	14/21	1	60.00000	Exact
56	35/49	1	56.00000	Exact	60	26/39	1	60.00000	Exact

Table 1b. (Continued) Simple and Compound Indexing with Brown & Sharpe Plates

Target Divisions	Indexing Movements	Workpiece Revolutions	Precise Number of Divisions	Diameter at Which Error = 0.001	Target Divisions	Indexing Movements	Workpiece Revolutions	Precise Number of Divisions	Diameter at Which Error = 0.001
61	$2\frac{2}{3}$ + 26/47	4	60.99981	102.93	94	20/47	1	94.00000	Exact
61 ^a	$3\frac{2}{3}$ + 2/49	6	60.99989	175.94	95	8/19	1	95.00000	Exact
61	$4\frac{1}{3}$ + 2/49	8	61.00009	204.64	96 ^a	3/18 + 5/20	1	96.00000	Exact
62	20/31	1	62.00000	Exact	97	15/41 + 2/43	1	97.00138	22.45
63	11/21 + 3/27	1	63.00000	Exact	97	$1\frac{2}{3}$ + 4/47	5	97.00024	128.66
63 ^a	$4\frac{2}{3}$ + 14/33	8	62.99938	32.49	97 ^a	$3\frac{2}{3}$ + 43/49	11	96.99989	281.37
64	10/16	1	64.00000	Exact	98	20/49	1	98.00000	Exact
65	24/39	1	65.00000	Exact	99 ^a	6/27 + 6/33	1	99.00000	Exact
66	20/33	1	66.00000	Exact	100	6/15	1	100.00000	Exact
67	29/37 + 16/39	2	66.99942	36.75	101	$1\frac{3}{5}$ + 10/47	5	100.99950	64.33
67	$2\frac{2}{3}$ + 16/49	5	67.00017	127.90	101	$2\frac{2}{3}$ + 2/47	7	100.99979	154.99
67	$4\frac{2}{3}$ + $2\frac{2}{3}$	11	67.00007	295.10	101 ^a	$3\frac{2}{3}$ + 30/49	11	101.00011	295.10
68	10/17	1	68.00000	Exact	102	5/15 + 1/17	1	102.00000	Exact
69	14/21 - 2/23	1	69.00000	Exact	102 ^a	$3\frac{1}{2}$ + 45/49	11	102.00022	147.55
69 ^a	19/23 + 11/33	2	69.00000	Exact	103 ^a	$1\frac{1}{2}$ + 18/49	4	103.00031	107.31
70	12/21	1	70.00000	Exact	103	$2\frac{2}{3}$ + 21/41	8	103.00021	154.52
70	28/49	1	70.00000	Exact	103	$4\frac{2}{3}$ + 9/49	13	103.00011	300.09
71	35/37 + 32/43	3	71.00037	60.77	104	15/39	1	104.00000	Exact
71 ^a	$2\frac{2}{3}$ + 27/49	6	70.99985	153.48	105	8/21	1	105.00000	Exact
71	$4\frac{2}{3}$ + $2\frac{2}{3}$	13	70.99991	264.67	106	$1\frac{2}{3}$ + 29/41	5	105.99934	50.90
72	10/18	1	72.00000	Exact	106	$2\frac{2}{3}$ + 15/43	7	105.99957	78.57
72	15/27	1	72.00000	Exact	106 ^a	$2\frac{2}{3}$ + 23/49	9	106.00029	115.11
73	5/43 + 48/49	2	73.00130	17.88	107	23/43 + 10/47	2	107.00199	17.15
73	$2\frac{2}{3}$ + 14/47	5	72.99982	128.66	107 ^a	$1\frac{2}{3}$ + 31/33	7	107.00037	91.18
73	$2\frac{2}{3}$ + $3\frac{2}{3}$	12	73.00007	351.87	107	$2\frac{2}{3}$ + 3/47	8	106.99983	196.28
73 ^a	$5\frac{2}{3}$ + 48/49	12	73.00007	351.87	107	$3\frac{2}{3}$ + 22/43	12	106.99987	256.23
74	20/37	1	74.00000	Exact	108	10/27	1	108.00000	Exact
75	8/15	1	75.00000	Exact	109	$1\frac{2}{3}$ + 2/23	4	108.99859	24.60
76	10/19	1	76.00000	Exact	109	$1\frac{2}{3}$ + 26/47	6	108.99974	132.85
77 ^a	9/21 + 3/33	1	77.00000	Exact	109 ^a	$2\frac{2}{3}$ + 4/49	7	108.99980	170.32
78	20/39	1	78.00000	Exact	110	12/33	1	110.00000	Exact
79	17/37 + 26/47	2	79.00057	44.28	111	1/37 + 13/39	1	111.00000	Exact
79 ^a	$2\frac{2}{3}$ + 3/49	6	79.00016	160.96	111 ^a	$3\frac{2}{3}$ + 17/49	11	111.00011	322.55
79	$4\frac{2}{3}$ + 9/47	10	79.00011	233.38	112 ^a	$3\frac{2}{3}$ + 20/33	11	111.99801	17.91
80	8/16	1	80.00000	Exact	112	33/43 + $2\frac{2}{3}$	9	112.00123	28.95
81	10/43 + 37/49	2	80.99952	53.65	112	14/37 + $4\frac{2}{3}$	15	112.00086	41.52
81	$3\frac{2}{3}$ + 13/49	7	80.99987	205.26	112	$9\frac{2}{3}$ + 46/47	29	112.00044	80.26
81 ^a	$4\frac{2}{3}$ + 40/49	10	80.99990	255.79	113	14/37 - 1/41	1	112.99814	19.32
81	$5\frac{1}{3}$ + $1\frac{2}{3}$	13	81.00009	300.09	113	$2\frac{2}{3}$ + 7/47	8	112.99982	196.28
82	20/41	1	82.00000	Exact	113 ^a	$2\frac{2}{3}$ + 31/49	9	112.99986	263.90
83	$1\frac{1}{2}$ + 17/31	4	83.00058	45.79	113	$4\frac{2}{3}$ + 3/49	13	113.00012	300.09
83 ^a	$2\frac{2}{3}$ + 44/49	8	83.00034	78.19	114 ^a	10/15 - 6/19	1	114.00000	Exact
83	$3\frac{1}{3}$ + 7/31	8	82.99969	85.26	114	$1\frac{2}{3}$ + 25/49	7	113.99955	80.79
83	$5\frac{1}{3}$ + 31/41	12	83.00011	231.78	115	8/23	1	115.00000	Exact
84	10/21	1	84.00000	Exact	116	10/29	1	116.00000	Exact
85	8/17	1	85.00000	Exact	117	$1\frac{1}{2}$ + 15/47	5	117.00061	61.34
86	20/43	1	86.00000	Exact	117	$7\frac{1}{3}$ - 9/49	20	117.00006	586.45
87	14/21 - 6/29	1	87.00000	Exact	117 ^a	$6\frac{1}{3}$ + 40/49	20	117.00006	586.45
87	17/29 + 11/33	2	87.00000	Exact	118 ^a	$1\frac{1}{3}$ + 24/49	5	117.99938	60.83
88	15/33	1	88.00000	Exact	118	30/41 + $2\frac{1}{3}$	9	117.99966	110.41
89	$1\frac{2}{3}$ + 19/41	5	88.99971	96.58	119	15/43 + 31/47	3	118.99902	38.60
89	$2\frac{2}{3}$ + 5/49	6	88.99980	138.50	119 ^a	$2\frac{2}{3}$ + 17/33	8	119.00049	77.31
89 ^a	$2\frac{2}{3}$ + 43/49	8	89.00015	194.65	119	$3\frac{2}{3}$ + 25/47	13	118.99987	287.84
90	8/18	1	90.00000	Exact	120	5/15	1	120.00000	Exact
90	12/27	1	90.00000	Exact	120	7/21	1	120.00000	Exact
91 ^a	6/39 + 14/49	1	91.00000	Exact	120	13/39	1	120.00000	Exact
92	10/23	1	92.00000	Exact	121	8/37 + 38/49	3	121.00111	34.63
93	7/21 + 3/31	1	93.00000	Exact	121 ^a	14/47 + 34/49	3	120.99825	21.99
93 ^a	3/31 + 11/33	1	93.00000	Exact	121	$1\frac{1}{2}$ + $2\frac{2}{3}$	10	120.99985	257.32

Table 1b. (Continued) Simple and Compound Indexing with Brown & Sharpe Plates

Target Divisions	Indexing Movements	Workpiece Revolutions	Precise Number of Divisions	Diameter at Which Error = 0.001	Target Divisions	Indexing Movements	Workpiece Revolutions	Precise Number of Divisions	Diameter at Which Error = 0.001
122	$1\frac{1}{4}_1 + 14/47$	5	122.00063	61.34	147	13/39 - 3/49	1	147.00000	Exact
122	$41/43 + 2\frac{3}{4}_9$	11	122.00026	147.55	147 ^a	13/39 + 37/49	4	147.00000	Exact
122 ^a	$2\frac{1}{3}_3 + 32/49$	11	122.00026	147.55	148	10/37	1	148.00000	Exact
123	$26/39 - 14/41$	1	123.00000	Exact	149	$28/41 + 6/49$	3	148.99876	38.37
123 ^a	$1\frac{1}{2}_3 + 17/49$	5	123.00058	67.07	149	$1\frac{7}{9}_9 + 7/43$	5	149.00044	106.76
124	10/31	1	124.00000	Exact	149 ^a	$2\frac{5}{6}_6 + 41/49$	11	149.00032	147.55
125	$41/43 + 16/49$	4	124.99815	21.46	149	$26/37 + 2\frac{3}{7}_7$	13	148.99984	287.84
125	$1\frac{3}{4}_4 + 37/49$	8	125.00097	40.93	150	4/15	1	150.00000	Exact
125	$2\frac{1}{3}_3 + 8/47$	7	125.00110	36.03	151	$5/37 + 31/47$	3	150.99855	33.21
125	$3/41 + 3\frac{3}{7}_7$	11	125.00074	53.98	151 ^a	$42/43 + 43/49$	7	151.00077	62.60
126	$2/21 + 6/27$	1	126.00000	Exact	151	$6/37 + 35/39$	4	151.00065	73.49
126	$2\frac{1}{6}_6 + 13/20$	11	125.99849	26.61	151	$2\frac{1}{3}_3 + 20/47$	11	151.00017	283.05
127	$2/39 + 42/47$	3	126.99769	17.50	152	5/19	1	152.00000	Exact
127	$2\frac{3}{7}_7 + 2/47$	7	127.00052	77.50	153	$10/18 - 5/17$	1	153.00000	Exact
127 ^a	$2\frac{2}{3}_3 + 12/49$	9	127.00018	218.98	153 ^a	$1\frac{4}{7}_7 + 45/49$	11	153.00015	322.55
128	5/16	1	128.00000	Exact	154 ^a	$1/21 + 7/33$	1	154.00000	Exact
129	$13/39 - 1/43$	1	129.00000	Exact	155	8/31	1	155.00000	Exact
129 ^a	$5\frac{3}{4}_4 + 15/49$	19	128.99966	121.50	156	10/39	1	156.00000	Exact
130	12/39	1	130.00000	Exact	157	$18/47 - 5/39$	1	157.00214	23.34
131	$5/37 + 8/47$	1	130.99812	22.14	157	$22/47 + 27/49$	4	157.00043	117.29
131 ^a	$2\frac{1}{3}_3 + 21/49$	11	130.99901	42.16	157 ^a	$2\frac{3}{31} + 2/33$	11	157.00035	143.28
131	$4/37 + 1\frac{1}{3}_3$	5	131.00041	101.29	157	$22/41 + 2\frac{1}{6}_6$	13	157.00030	166.27
131	$2\frac{2}{3}_3 + 20/47$	10	130.99984	257.32	158 ^a	$4\frac{1}{3}_3 + 34/49$	19	157.99901	50.97
132	10/33	1	132.00000	Exact	158	$1\frac{1}{9}_9 + 8/49$	5	157.99917	60.83
133	$1/37 + 27/47$	2	133.00191	22.14	158	$1\frac{2}{9}_9 + 23/43$	9	158.00052	96.09
133	$12/31 + 17/33$	3	133.00108	39.08	159	$14/37 + 27/43$	4	159.00062	81.03
133 ^a	$2\frac{2}{3}_3 + 17/33$	11	133.00063	67.02	159	$1\frac{1}{3}_3 + 15/47$	7	158.99972	180.13
133	$1\frac{2}{3}_3 + 19/31$	8	133.00046	91.57	159 ^a	$2\frac{1}{7}_7 + 16/49$	10	159.00022	230.84
134	$4/29 + 25/33$	3	134.00233	18.28	160	4/16	1	160.00000	Exact
134	$1\frac{1}{3}_3 + 37/47$	7	133.99953	90.06	161	$9/23 - 3/21$	1	161.00000	Exact
134 ^a	$3\frac{2}{7}_7 + 15/49$	13	134.00022	190.60	161 ^a	$1\frac{1}{9}_9 + 48/49$	9	161.00164	31.28
135	8/27	1	135.00000	Exact	162	$28/47 - 15/43$	1	162.00401	12.87
136	5/17	1	136.00000	Exact	162	$1\frac{3}{39} - 2/49$	7	161.99818	28.39
137	$9/37 + 31/49$	3	137.00252	17.31	162 ^a	$\frac{3}{49} + 47/49$	7	161.99818	28.39
137	$11/41 + 1\frac{8}{9}_9$	7	136.99951	89.53	162	$2\frac{1}{21} + 25/29$	13	161.99907	55.20
137	$17/43 + 2\frac{1}{9}_9$	11	137.00015	295.10	163	$18/49 - 5/41$	1	163.00203	25.58
137 ^a	$2\frac{1}{3}_3 + 40/49$	11	137.00015	295.10	163	$19/37 + 22/47$	4	162.99941	88.57
138	$7/21 - 1/23$	1	138.00000	Exact	163 ^a	$2\frac{1}{37} + 25/49$	11	162.99959	126.96
138 ^a	$18/23 + 22/33$	5	138.00000	Exact	163	$2\frac{1}{47} + 26/49$	13	162.99986	381.20
139	$23/41 + 13/43$	3	139.00131	33.67	164	10/41	1	164.00000	Exact
139	$1\frac{1}{3}_3 + 9/41$	7	139.00031	142.51	165	8/33	1	165.00000	Exact
139	$3\frac{1}{3}_3 + 6/47$	12	138.99986	308.79	166	$20/29 + 17/33$	5	166.00173	30.46
139 ^a	$2\frac{2}{7}_7 + 24/49$	11	138.99983	253.92	166 ^a	$1\frac{1}{43} + 12/49$	7	165.99887	46.95
140	6/21	1	140.00000	Exact	166	$2\frac{1}{41} + 7/43$	11	166.00043	123.46
141	$29/47 - 13/39$	1	141.00000	Exact	167 ^a	$2\frac{1}{29} + 4/33$	9	166.99952	109.66
141 ^a	$1\frac{2}{9}_9 + 22/49$	8	141.00069	64.88	167	$23/43 + 9/49$	3	167.00132	40.24
142	$23/39 + 12/47$	3	142.00129	35.01	167	$6/37 + 39/49$	4	167.00058	92.34
142	$18/41 + 2\frac{1}{7}_7$	11	141.99967	134.94	167	$2\frac{2}{37} + 20/43$	13	167.00040	131.67
142 ^a	$4\frac{1}{7}_7 + 10/49$	15	141.99979	219.92	168	5/21	1	168.00000	Exact
143 ^a	$36/47 + 31/49$	5	142.99907	48.87	169	$1/41 + 22/49$	2	169.00105	51.16
143	$13/37 + 20/41$	3	143.00079	57.95	169 ^a	$1\frac{3}{37} + 13/49$	9	169.00052	103.88
143	$1\frac{1}{6}_6 + 20/31$	8	143.00053	85.26	170	4/17	1	170.00000	Exact
144	5/18	1	144.00000	Exact	171	$8/18 - 4/19$	1	171.00000	Exact
145	8/29	1	145.00000	Exact	171 ^a	$1\frac{1}{47} + 1/49$	7	170.99973	205.26
146	$16/41 - 5/43$	1	146.00044	11.22	172	10/43	1	172.00000	Exact
146	$3/37 + 1\frac{1}{6}_6$	7	145.99942	80.79	173	$27/37 + 8/41$	4	173.00071	77.26
146 ^a	$1\frac{1}{37} + 41/49$	7	145.99942	80.79	173 ^a	$1\frac{1}{43} + 11/49$	6	173.00034	160.96
146	$28/37 + 2\frac{3}{41}$	13	146.00037	125.55					

Table 1b. (Continued) Simple and Compound Indexing with Brown & Sharpe Plates

Target Divisions	Indexing Movements	Workpiece Revolutions	Precise Number of Divisions	Diameter at Which Error = 0.001	Target Divisions	Indexing Movements	Workpiece Revolutions	Precise Number of Divisions	Diameter at Which Error = 0.001
174	7/21 - 3/29	1	174.00000	Exact	199	16/41 + 10/47	3	199.00172	36.80
174 ^a	14/29 + 22/33	5	174.00000	Exact	199	26/37 + 13/43	5	198.99937	101.29
175	3/37 + 26/43	3	174.99542	12.15	199 ^a	1 ¹ / ₄₁ + 45/49	11	199.00045	140.69
175 ^a	1 ¹ / ₃₁ + 8/33	6	174.99644	15.63	199	1 ¹ / ₄₃ + 31/47	13	199.00019	334.52
175	1 ¹ / ₃₇ + 5/39	6	174.99747	22.05	200	3/15	1	200.00000	Exact
175	2 ¹ / ₄₁ + 15/47	11	175.00103	53.98	201	27/37 + 13/49	5	200.99778	28.85
176 ^a	1 ¹ / ₄₃ + 13/49	7	176.00239	23.47	201	1 ¹ / ₄₁ + 27/49	10	201.00050	127.90
176	2 ¹ / ₃₇ + 22/47	13	175.99844	35.98	201 ^a	2 ¹ / ₄₃ + 10/49	13	201.00034	190.60
177	6/37 + 3/47	1	176.99746	22.14	201	2 ¹ / ₄₁ + 20/43	13	200.99778	291.81
177	1 ¹ / ₃₇ + 6/49	7	177.00139	40.40	202	24/37 + 14/41	5	201.99734	24.14
177 ^a	2 ¹ / ₄₇ + 4/49	11	176.99913	64.51	202 ^a	3 ¹ / ₄₁ + 6/49	17	201.99911	72.47
178	1 ¹ / ₃₉ + 7/43	7	177.99848	37.37	202	1/43 + 2 ¹ / ₄₉	13	201.99853	43.59
178 ^a	3 ¹ / ₄₇ + 11/49	17	177.99955	124.62	203	14/29 - 6/21	1	203.00000	Exact
178	2 ¹ / ₄₁ + 32/49	13	177.99966	166.27	203 ^a	1 ² / ₃₉ + 9/49	9	202.99793	31.28
179	20/37 - 13/41	1	178.99705	19.31	204	9/17 - 5/15	1	204.00000	Exact
179	14/39 + 23/43	4	178.99933	85.41	204 ^a	2 ¹ / ₄₁ + 3/49	13	203.99922	83.13
179 ^a	1 ¹ / ₄₇ + 36/49	11	179.00018	322.55	205	8/41	1	205.00000	Exact
180	4/18	1	180.00000	Exact	206	1/41 + 24/43	3	205.99805	33.67
180	6/27	1	180.00000	Exact	206	2 ¹ / ₃₉ + 15/47	13	205.99957	151.70
181	20/37 + 6/49	3	180.99834	34.63	206 ^a	2 ¹ / ₃₉ + 2/49	15	206.00072	91.24
181 ^a	2 ¹ / ₄₃ + 12/49	11	180.99961	147.55	207	5/23 + 15/27	4	207.00000	Exact
181	39/41 + 28/47	7	180.99966	171.75	207 ^a	2 ¹ / ₄₁ + 25/49	14	206.99908	71.62
181	2 ¹ / ₃₉ + 21/47	12	180.99979	280.06	208	8/43 + 38/49	5	207.99605	16.77
182 ^a	3/39 + 7/49	1	182.00000	Exact	208 ^a	1 ¹ / ₄₇ + 16/49	9	207.99799	32.99
183	8/29 + 5/31	2	183.00254	22.89	208	3 ¹ / ₄₃ + 11/49	21	208.00094	70.42
183	1/43 + 40/47	4	182.99943	102.93	209 ^a	9/41 + 8/49	2	208.99870	51.16
183 ^a	1 ¹ / ₄₁ + 8/49	8	183.00028	204.64	209	1 ¹ / ₄₁ + 18/43	12	208.99975	269.37
184	5/23	1	184.00000	Exact	210	4/21	1	210.00000	Exact
185	8/37	1	185.00000	Exact	211 ^a	1 ² / ₃₉ + 18/49	11	211.00125	53.53
186	17/31 - 7/21	1	186.00000	Exact	211	35/37 + 9/47	6	211.00101	66.42
186 ^a	3/31 + 11/33	2	186.00000	Exact	211	1 ¹ / ₃₇ + 17/39	9	210.99919	82.68
187	19/37 + 5/39	3	186.99784	27.56	211	1 ³ / ₄₁ + 31/47	13	211.00021	318.96
187 ^a	1 ² / ₄₇ + 14/49	8	186.99822	33.51	212	34/39 + 22/49	7	211.99683	21.29
187	21/23 + 10/27	6	187.00125	47.44	212	1 ¹ / ₄₃ + 47/49	11	212.00091	73.77
187	1 ³ / ₄₃ + 12/47	10	186.99977	257.32	212 ^a	3 ¹ / ₄₇ + 6/49	17	211.99946	124.62
188	10/47	1	188.00000	Exact	213 ^a	1 ¹ / ₃₉ + 2/49	8	212.99896	64.88
189	7/27 - 1/21	1	189.00000	Exact	213	14/37 + 44/47	7	213.00087	77.50
189 ^a	1 ¹ / ₄₁ + 34/49	11	189.00150	40.20	213	2 ¹ / ₃₉ + 9/41	17	213.00021	328.36
190	4/19	1	190.00000	Exact	214	7/39 + 37/49	5	213.99776	30.41
191	1/21 + 18/31	3	191.00244	24.87	214 ^a	2 ¹ / ₄₇ + 30/49	15	214.00031	219.92
191 ^a	1 ³ / ₄₉ + 14/49	10	191.00145	41.89	215	8/43	1	215.00000	Exact
191	34/37 + 5/39	5	190.99934	91.86	216	5/27	1	216.00000	Exact
191	28/39 + 45/47	8	190.99967	186.71	217	12/21 - 12/31	1	217.00000	Exact
192	5/15 - 2/16	1	192.00000	Exact	217 ^a	2 ¹ / ₄₃ + 16/49	13	217.00139	49.82
192 ^a	1 ² / ₄₁ + 37/49	11	191.99826	35.17	218	14/39 + 9/47	3	217.99802	35.01
193 ^a	5/37 + 34/49	4	193.00067	92.34	218 ^a	22/47 + 40/49	7	217.99865	51.31
193	29/39 + 12/41	5	192.99940	101.80	218	19/37 + 1 ¹ / ₃₉	13	218.00116	59.71
194	41/43 + 24/49	7	194.00197	31.30	219	24/39 + 14/47	5	218.99642	19.45
194 ^a	1 ² / ₃₇ + 33/49	11	193.99805	31.74	219 ^a	2 ¹ / ₄₃ + 39/49	19	218.99891	63.71
194	1 ² / ₃₇ + 11/47	9	194.00062	99.64	219	1 ¹ / ₃₇ + 11/49	7	218.99914	80.79
194	2 ¹ / ₄₇ + 25/49	13	193.99968	190.60	219	2 ¹ / ₄₁ + 41/49	17	218.99968	217.42
195	8/39	1	195.00000	Exact	220	6/33	1	220.00000	Exact
196	10/49	1	196.00000	Exact	221	26/37 + 1/47	4	221.00079	88.57
197	17/37 - 10/39	1	196.99659	18.37	221 ^a	5/47 + 48/49	6	220.99960	175.94
197	19/39 + 5/41	3	197.00205	30.54	221	3 ¹ / ₄₁ + 25/43	21	220.99985	471.39
197 ^a	1 ³ / ₄₃ + 16/49	11	196.99958	147.55	222	19/37 - 13/39	1	222.00000	Exact
198 ^a	3/27 + 3/33	1	198.00000	Exact	222 ^a	1 ¹ / ₄₃ + 39/49	11	222.00192	36.89

Table 1b. (Continued) Simple and Compound Indexing with Brown & Sharpe Plates

Target Divisions	Indexing Movements	Workpiece Revolutions	Precise Number of Divisions	Diameter at Which Error = 0.001	Target Divisions	Indexing Movements	Workpiece Revolutions	Precise Number of Divisions	Diameter at Which Error = 0.001
223	6/37 + 36/49	25	223.00123	57.71	239	1/37 + 12/39	2	239.00621	12.25
223	1 ³⁵ / ₃₇ + 38/47	14	222.99977	309.98	239	32/39 + 9/49	6	238.99948	145.99
223 ^a	2 ²⁵ / ₄₃ + 13/49	16	222.99983	429.23	239 ^a	1 ²⁵ / ₄₃ + 15/49	11	238.99974	295.10
224	3 ¹¹ / ₄₁ + 15/47	20	223.00014	490.71	239	2 ¹¹ / ₄₁ + 26/43	16	239.00021	359.16
224	1 ¹⁵ / ₃₇ + 11/43	9	223.99687	22.79	240	3/18	1	240.00000	Exact
224	2 ¹⁶ / ₃₉ + 11/41	15	224.00187	38.17	241	4/39 + 17/43	3	241.00599	12.81
224 ^a	2 ²⁵ / ₂₁ + 2/33	13	223.99546	15.70	241	26/41 + 17/47	6	241.00052	147.21
224	3 ⁵ / ₄₃ + 13/47	19	223.99883	61.11	241 ^a	1 ¹¹ / ₄₁ + 23/49	9	240.99967	230.21
225	1/15 + 2/18	1	225.00000	Exact	241	1 ²⁵ / ₃₇ + 35/43	15	240.99975	303.86
225 ^a	1/18 + 6/20	2	225.00000	Exact	242	4/37 + 19/49	3	242.00222	34.63
226	28/37 + 5/39	5	225.99843	45.93	242	1 ³⁵ / ₃₉ + 26/49	15	242.00084	91.24
226 ^a	1 ³⁸ / ₃₉ + 16/49	13	225.99955	158.16	242 ^a	1 ²⁵ / ₄₁ + 45/49	15	241.99960	191.85
227	9/39 + 14/47	3	226.99690	23.34	242	2 ²⁵ / ₃₉ + 39/43	21	241.99966	224.20
227	1 ¹⁵ / ₃₇ + 25/39	11	227.00036	202.10	243	22/37 + 3/47	4	243.00437	17.71
227 ^a	3 ⁵ / ₄₃ + 5/49	18	226.99985	482.89	243	32/41 + 2/47	5	243.00126	61.34
228	5/15 - 3/19	1	228.00000	Exact	243 ^a	29/41 + 46/49	10	242.99970	255.79
229	7/39 + 34/49	5	228.99940	121.66	244	36/39 + 11/49	7	243.99453	14.19
229 ^a	1 ¹⁸ / ₄₁ + 31/49	12	229.00024	306.95	244	1 ¹⁸ / ₃₉ + 8/39	9	244.00188	41.34
229	2 ²⁵ / ₄₁ + 20/43	19	229.00017	426.50	244	2 ¹⁵ / ₃₁ + 10/33	17	243.99860	55.36
230	4/23	1	230.00000	Exact	244 ^a	1 ²⁵ / ₃₉ + 2/43	11	244.00139	55.71
231 ^a	3/21 + 1/33	1	231.00000	Exact	245	8/49	1	245.00000	Exact
232	5/29	1	232.00000	Exact	246	13/39 - 7/41	1	246.00000	Exact
233	2/37 + 31/49	4	232.99598	18.47	246 ^a	6/43 + 33/49	5	246.00117	67.07
233 ^a	1 ³⁰ / ₄₇ + 6/49	11	233.00069	107.52	247	17/37 + 21/41	6	247.00136	57.59
233	21/37 + 26/41	7	233.00055	135.21	247	15/43 + 1 ¹⁵ / ₃₉	14	247.00021	375.58
233	1 ²⁵ / ₃₇ + 41/43	15	232.99976	303.86	247 ^a	1 ¹⁵ / ₄₃ + 45/49	14	247.00021	375.58
234 ^a	2 ²¹ / ₃₉ + 6/33	17	234.00216	34.52	248	5/31	1	248.00000	Exact
234	8/41 + 31/47	5	234.00121	61.34	249	20/37 + 5/49	4	248.99571	18.47
234	2 ¹⁷ / ₄₃ + 24/47	17	233.99966	218.72	249	10/37 + 1 ¹⁸ / ₄₇	14	249.00026	309.98
235	8/47	1	235.00000	Exact	249	4/43 + 2 ¹⁵ / ₄₉	19	249.00016	509.72
236	22/37 + 29/49	7	236.00186	40.40	249 ^a	2 ¹⁵ / ₄₃ + 47/49	19	249.00016	509.72
236 ^a	2 ³⁰ / ₄₃ + 9/49	17	236.00066	114.02	250	1 ¹⁶ / ₄₁ + 12/49	9	249.99654	23.02
237	1 ¹⁸ / ₃₉ + 7/41	8	236.99861	54.29	250 ^a	1 ¹⁵ / ₃₇ + 41/49	13	250.00265	30.01
237	1 ³⁰ / ₃₇ + 6/39	11	236.99888	67.37	250	2 ¹⁵ / ₄₃ + 33/49	17	250.00174	45.61
237	12/47 + 1 ¹⁸ / ₄₉	13	236.99980	381.20	250	3 ¹⁵ / ₄₇ + 48/49	27	249.99899	79.17
237 ^a	1 ¹² / ₄₇ + 46/49	13	236.99980	381.20
238	7/37 + 28/43	5	237.99551	16.88
238	1/43 + 1 ²⁵ / ₄₇	9	237.99804	38.60
238 ^a	2 ⁵ / ₃₁ + 14/33	15	237.99922	97.69
238	2 ¹⁵ / ₃₉ + 4/47	15	238.00043	175.04

^a Requires only the outer most circle of holes on indexing plate.

The greater spacing between successive machining operations may be used to advantage to spread out and reduce the effects of heat generation on the workpiece. The number of workpiece revolutions required by an approximation is shown in the table in the column to the right of the indexing movements. The table gives two or three choices for each division requiring approximate movements.

Two measures of the closeness of each approximation are provided to aid in the trade-off between complexity and precision. The first measure is the precise number of divisions that a set of indexing movements produces, offering a direct comparison of the degree of approximation. However, the difference between the precise number of divisions and the target number of divisions is angular in nature, so the error introduced by an approximation depends on the size of the circle being divided. The second measure of closeness reflects this characteristic by expressing the degree of approximation as the diameter at which the error is equal to 0.001. This second measure is unitless, so that taking the error as 0.001 inch means that the entries in that column are to be taken as diameters in inches, but the

measure works as well with 0.001 centimeter and diameters in centimeters. The measure can also be used to calculate the error of approximation at a given diameter. Divide the given diameter by the value of the measure and multiply the result by 0.001 to determine the amount of error that using an approximation will introduce.

Example: A gear is to be cut with 127 teeth at 16 diametral pitch using a Brown & Sharpe plain dividing head. The indexing table gives three approximations for 127 divisions. The pitch diameter of a 16 DP gear with 127 teeth is about 7.9 inches, so the calculated error of approximation for the three choices would be about $(7.9 \div 17.5) \times 0.001 = 0.00045$ inch, $(7.9 \div 77.5) \times 0.001 = 0.00010$ inch, and $(7.9 \div 218.98) \times 0.001 = 0.000036$ inch. Considering the increased potential for operator error with longer indexing movements and such other factors as may be appropriate, assume that the first of the three approximations is selected. Plate 3 is mounted on the worm shaft of the dividing head but not bolted to the frame. A double set of sector arms is installed, if available; otherwise, the single pair of sector arms is installed. The indexing pin on the crank arm is set to track the 39-hole circle. The stationary indexing pin is installed and set to track the 47-hole circle. If only one pair of sector arms is used, it is used for the 42/47 movement and is set for 0-42 holes using the outer arc. Six holes should be showing in the inner arc on the 47-hole circle (the zero-hole, the 42-hole, and four extra holes). The second set of sector arms is set for 0-2 holes on the 39-hole circle using the inner arc (three holes showing). If there is no second pair of sector arms, this is a short enough movement to do freehand without adding much risk of error.

Angular Indexing.—The plain dividing head with a 40:1 gear ratio will rotate the main spindle and the workpiece 9 degrees for each full turn of the indexing crank, and therefore 1 degree for movements of 2/18 or 3/27 on Brown & Sharpe dividing heads and 6/54 on heads of Cincinnati design. To find the indexing movement for an angle, divide that angle, in degrees, by 9 to get the number of full turns and the remainder, if any. If the remainder, expressed in minutes, is evenly divisible by 36, 33.75, 30, 27, or 20, then the quotient is the number of holes to be moved on the 15-, 16-, 18-, 20-, or 27-hole circles, respectively, to obtain the fractional turn required (or evenly divisible by 22.5, 21.6, 18, 16.875, 15, 11.25, or 10 for the number of holes to be moved on the 24-, 25-, 30-, 32-, 36-, 48-, or 54-hole circles, respectively, for the standard and high number plates of a Cincinnati dividing head). If none of these divisions is even, it is not possible to index the angle (exactly) by this method.

Example: An angle of $61^{\circ} 48'$ is required. Expressed in degrees, this angle is 61.8° , which when divided by 9 equals 6 with a remainder of 7.8° , or $468'$. Division of 468 by 20, 27, 30, 33.75, and 36 reveals an even division by 36, yielding 13. The indexing movement for $61^{\circ} 48'$ is six full turns plus 13 holes on the 15-hole circle.

Tables for Angular Indexing.—Table 2, headed *Angular Values of One-Hole Moves*, provides the angular movement obtained with a move of one hole in each of the indexing circles available on standard Brown & Sharpe and Cincinnati plates, for a selection of angles that can be approximated with simple indexing.

Table 3, titled *Accurate Angular Indexing*, provides the simple and compound indexing movements to obtain the full range of fractional turns with the standard indexing plates of both the Brown & Sharpe and Cincinnati dividing heads. Compound indexing movements depend on the presence of specific indexing circles on the same indexing plate, so some movements may not be available with plates of different configurations. To use the table to index an angle, first convert the angle to seconds and then divide the number of seconds in the angle by 32,400 (the number of seconds in 9 degrees, which is one full turn of the indexing crank). The whole-number portion of the quotient gives the number of full turns of the indexing crank, and the decimal fraction of the quotient gives the fractional turn required.

Table 2. Angular Values of One-Hole Moves for B&S and Cincinnati Index Plates

Holes in Circle	Angle in Minutes	Holes in Circle	Angle in Minutes	Holes in Circle	Angle in Minutes
15	36.000	53	10.189	129	4.186
16	33.750	54	10.000	131	4.122
17	31.765	57	9.474	133	4.060
18	30.000	58	9.310	137	3.942
19	28.421	59	9.153	139	3.885
20	27.000	62	8.710	141	3.830
21	25.714	66	8.182	143	3.776
23	23.478	67	8.060	147	3.673
24	22.500	69	7.826	149	3.624
25	21.600	71	7.606	151	3.576
26	20.769	73	7.397	153	3.529
27	20.000	77	7.013	157	3.439
28	19.286	79	6.835	159	3.396
29	18.621	81	6.667	161	3.354
30	18.000	83	6.506	163	3.313
31	17.419	87	6.207	167	3.234
32	16.875	89	6.067	169	3.195
33	16.364	91	5.934	171	3.158
34	15.882	93	5.806	173	3.121
36	15.000	97	5.567	175	3.086
37	14.595	99	5.455	177	3.051
38	14.211	101	5.347	179	3.017
39	13.846	103	5.243	181	2.983
41	13.171	107	5.047	183	2.951
42	12.857	109	4.954	187	2.888
43	12.558	111	4.865	189	2.857
44	12.273	113	4.779	191	2.827
46	11.739	117	4.615	193	2.798
47	11.489	119	4.538	197	2.741
48	11.250	121	4.463	199	2.714
49	11.020	123	4.390
51	10.588	127	4.252

Use **Table 3** to locate the indexing movement for the decimal fraction nearest to the decimal fraction of the quotient for which there is an entry in the column for the dividing head to be used. If the decimal fraction of the quotient is close to the midpoint between two table entries, calculate the mathematical value of the two indexing movements to more decimal places to make the closeness determination.

Example: Movement through an angle of $31^{\circ} 27' 50''$ is required. Expressed in seconds, this angle $113270''$, which, divided by 32,400, equals 3.495987. The indexing movement is three full turns of the crank plus a fractional turn of 0.495987. The nearest **Table 3** entry is for 0.4960, which requires a compound indexing movement of 8 holes on the 23-hole circle plus 4 holes on the 27-hole circle in the same direction. Checking the value of these movements shows that $\frac{8}{23} + \frac{4}{27} = 0.347826 + 0.148148 = 0.495974$, which, multiplied by 32,400, = 16,069.56, or $4^{\circ} 27' 49.56''$ from the fractional turn. Adding the 27° from three full turns gives a total movement of $31^{\circ} 27' 49.56''$.

Table 3. Accurate Angular Indexing

Part of a Turn	B&S, Becker, Hendey, K&T, & Rockford	Cincinnati and LeBlond	Part of a Turn	B&S, Becker, Hendey, K&T, & Rockford	Cincinnati and LeBlond
0.0010	12/49 – 10/41	15/51 – 17/58	0.0370	13/43 – 13/49	6/51 – 5/62
0.0020	24/49 – 20/41	23/51 – 22/49	0.0370	1/27	2/54
0.0030	8/23 – 10/29	7/39 – 6/34	0.0377	...	2/53
0.0040	1/41 – 1/49	4/66 – 3/53	0.0380	13/41 – 12/43	12/49 – 12/58
0.0050	4/39 – 4/41	3/24 – 3/25	0.0390	15/29 – 11/23	9/54 – 6/47
0.0060	9/29 – 7/23	18/51 – 17/49	0.0392	...	2/51
0.0070	11/31 – 8/23	5/46 – 6/59	0.0400	9/41 – 7/39	1/25
0.0080	2/41 – 2/49	10/49 – 10/51	0.0408	2/49	2/49
0.0090	1/23 – 1/29	8/24 – 12/37	0.0410	20/41 – 21/47	21/43 – 17/38
0.0100	8/39 – 8/41	6/24 – 6/25	0.0417	...	1/24
0.0110	6/39 – 7/49	11/59 – 10/57	0.0420	8/47 – 5/39	23/59 – 16/46
0.0120	9/47 – 7/39	15/49 – 15/51	0.0426	2/47	2/47
0.0130	2/33 – 1/21	3/54 – 2/47	0.0430	7/21 – 9/31	8/59 – 5/54
0.0140	19/47 – 16/41	10/46 – 12/59	0.0435	1/23	2/46
0.0150	8/29 – 6/23	9/24 – 9/25	0.0440	17/43 – 13/37	17/57 – 15/59
0.0152	...	1/66	0.0450	11/49 – 7/39	3/24 – 2/25
0.0160	18/49 – 13/37	20/49 – 20/51	0.0455	...	3/66
0.0161	...	1/62	0.0460	8/37 – 8/47	19/39 – 15/34
0.0169	...	1/59	0.0465	2/43	2/43
0.0170	15/41 – 15/43	9/49 – 11/66	0.0470	8/49 – 5/43	26/66 – 17/49
0.0172	...	1/58	0.0476	1/21	2/42
0.0175	...	1/57	0.0480	11/47 – 8/43	13/51 – 12/58
0.0180	9/39 – 10/47	11/42 – 10/41	0.0484	...	3/62
0.0185	...	1/54	0.0488	2/41	2/41
0.0189	...	1/53	0.0490	14/43 – 13/47	8/47 – 8/66
0.0190	7/37 – 8/47	6/49 – 6/58	0.0500	1/20	2/24 – 1/30
0.0196	...	1/51	0.0508	...	3/59
0.0200	16/39 – 16/41	3/30 – 2/25	0.0510	2/17 – 1/15	16/54 – 13/53
0.0204	1/49	1/49	0.0513	2/39	2/39
0.0210	3/43 – 2/41	15/46 – 18/59	0.0517	...	3/58
0.0213	1/47	1/47	0.0520	19/37 – 18/39	6/46 – 4/51
0.0217	...	1/46	0.0526	1/19	2/38
0.0220	12/37 – 13/43	22/59 – 20/57	0.0526	...	3/57
0.0230	4/37 – 4/47	3/47 – 2/49	0.0530	14/47 – 12/49	1/54 + 2/58
0.0233	1/43	1/43	0.0540	17/47 – 12/39	12/53 – 10/58
0.0238	...	1/42	0.0541	2/37	2/37
0.0240	18/47 – 14/39	23/58 – 19/51	0.0550	4/41 – 2/47	9/24 – 8/25
0.0244	1/41	1/41	0.0556	1/18	3/54
0.0250	2/16 – 2/20	2/30 – 1/24	0.0560	13/49 – 9/43	7/38 – 5/39
0.0256	1/39	1/39	0.0566	...	3/53
0.0260	4/33 – 2/21	3/46 – 2/51	0.0570	13/29 – 9/23	18/49 – 18/58
0.0263	...	1/38	0.0580	19/41 – 15/37	7/53 – 4/54
0.0270	3/23 – 3/29	6/53 – 5/58	0.0588	1/17	2/34
0.0270	1/37	1/37	0.0588	...	3/51
0.0280	17/43 – 18/49	20/46 – 24/59	0.0590	11/41 – 9/43	21/49 – 17/46
0.0290	11/37 – 11/41	4/49 – 3/57	0.0600	4/39 – 2/47	3/30 – 1/25
0.0294	...	1/34	0.0606	2/33	4/66
0.0300	2/39 – 1/47	7/25 – 6/24	0.0610	7/37 – 5/39	5/51 – 2/54
0.0303	1/33	2/66	0.0612	3/49	3/49
0.0310	13/39 – 13/43	13/34 – 13/37	0.0620	17/43 – 13/39	11/37 – 8/34
0.0320	11/37 – 13/49	8/37 – 7/38	0.0625	1/16	...
0.0323	1/31	2/62	0.0630	2/21 – 1/31	5/59 – 1/46
0.0330	11/49 – 9/47	11/49 – 9/47	0.0638	3/47	3/47
0.0333	...	1/30	0.0640	23/49 – 15/37	10/51 – 7/53
0.0339	...	2/59	0.0645	2/31	4/62
0.0340	18/49 – 13/39	18/49 – 17/51	0.0650	5/43 – 2/39	11/25 – 9/24
0.0345	1/29	2/58	0.0652	...	3/46
0.0350	13/41 – 11/39	4/25 – 3/24	0.0660	22/49 – 18/47	22/49 – 18/47
0.0351	...	2/57	0.0667	1/15	2/30
0.0357	...	1/28	0.0670	5/39 – 3/49	19/49 – 17/53
0.0360	18/39 – 20/47	21/41 – 20/42	0.0678	...	4/59

Table 3. (Continued) Accurate Angular Indexing

Part of a Turn	B&S, Becker, Hendeny, K&T, & Rockford	Cincinnati and LeBlond	Part of a Turn	B&S, Becker, Hendeny, K&T, & Rockford	Cincinnati and LeBlond
0.0680	9/39 - 7/43	23/51 - 18/47	0.0980	...	5/51
0.0690	2/29	4/58	0.0990	1/29 + 2/31	20/47 - 16/49
0.0690	12/37 - 12/47	7/66 - 2/54	0.1000	2/20	3/30
0.0698	3/43	3/43	0.1010	6/27 - 4/33	18/59 - 10/49
0.0700	8/33 - 5/29	8/25 - 6/24	0.1017	...	6/59
0.0702	...	4/57	0.1020	6/47 - 1/39	11/54 - 6/59
0.0710	17/43 - 12/37	11/58 - 7/59	0.1020	5/49	5/49
0.0714	...	2/28	0.1026	4/39	4/39
0.0714	...	3/42	0.1030	21/49 - 14/43	18/57 - 10/47
0.0720	7/47 - 3/39	10/49 - 7/53	0.1034	...	6/58
0.0730	9/37 - 8/47	1/47 + 3/58	0.1035	3/29	...
0.0732	3/41	3/41	0.1040	21/41 - 20/49	15/62 - 8/58
0.0740	23/49 - 17/43	19/42 - 14/37	0.1050	11/41 - 8/49	12/25 - 9/24
0.0741	2/27	4/54	0.1053	2/19	4/38
0.0750	2/16 - 1/20	1/24 + 1/30	0.1053	...	6/57
0.0755	...	4/53	0.1060	1/27 + 2/29	2/54 + 4/58
0.0758	...	5/66	0.1061	...	7/66
0.0760	17/47 - 14/49	24/49 - 24/58	0.1064	5/47	5/47
0.0769	3/39	3/39	0.1070	10/37 - 8/49	2/51 + 4/59
0.0770	...	9/46 - 7/59	0.1071	...	3/28
0.0771	6/37 - 4/47	...	0.1080	1/23 + 2/31	24/53 - 20/58
0.0780	13/39 - 12/47	9/46 - 6/51	0.1081	4/37	4/37
0.0784	...	4/51	0.1087	...	5/46
0.0789	...	3/38	0.1090	8/47 - 3/49	25/58 - 19/59
0.0790	20/37 - 18/39	21/39 - 17/37	0.1100	2/41 + 3/49	9/25 - 6/24
0.0800	9/37 - 8/49	2/25	0.1110	15/49 - 8/41	32/59 - 22/51
0.0806	...	5/62	0.1111	3/27	6/54
0.0810	9/23 - 9/29	17/47 - 16/57	0.1111	2/18	...
0.0811	3/37	3/37	0.1120	23/41 - 22/49	23/47 - 20/53
0.0816	4/49	4/49	0.1129	...	7/62
0.0820	5/47 - 1/41	4/38 - 1/43	0.1130	13/41 - 10/49	1/49 + 5/54
0.0830	4/23 - 3/33	8/46 - 6/66	0.1132	...	6/53
0.0833	...	2/24	0.1140	7/43 - 2/41	22/58 - 13/49
0.0840	8/43 - 5/49	8/47 - 5/58	0.1150	13/31 - 7/23	6/25 - 3/24
0.0847	...	5/59	0.1160	6/29 - 3/33	14/53 - 8/54
0.0850	9/17 - 8/18	3/24 - 1/25	0.1163	5/43	5/43
0.0851	4/47	4/47	0.1170	5/33 - 1/29	5/59 + 2/62
0.0860	13/31 - 7/21	16/59 - 10/54	0.1176	2/17	4/34
0.0862	...	5/58	0.1176	...	6/51
0.0870	2/23	4/46	0.1180	6/23 - 3/21	27/59 - 18/53
0.0870	5/33 - 2/31	21/54 - 16/53	0.1186	...	7/59
0.0877	...	5/57	0.1190	10/29 - 7/31	4/47 + 2/59
0.0880	8/37 - 5/39	28/57 - 25/62	0.1190	...	5/42
0.0882	...	3/34	0.1200	8/39 - 4/47	3/25
0.0890	6/37 - 3/41	22/53 - 15/46	0.1207	...	7/58
0.0900	22/49 - 14/39	6/24 - 4/25	0.1210	21/43 - 18/49	26/53 - 17/46
0.0909	3/33	6/66	0.1212	4/33	8/66
0.0910	23/49 - 14/37	21/51 - 17/53	0.1220	5/41	5/41
0.0920	4/31 - 1/27	4/34 - 1/39	0.1220	23/47 - 18/49	10/51 - 4/54
0.0926	...	5/54	0.1224	6/49	6/49
0.0930	15/29 - 14/33	5/34 - 2/37	0.1228	...	7/57
0.0930	4/43	4/43	0.1230	10/49 - 3/37	1/59 + 7/66
0.0940	23/47 - 17/43	15/49 - 14/66	0.1240	2/23 + 1/27	18/34 - 15/37
0.0943	...	5/53	0.1250	2/16	3/24
0.0950	5/43 - 1/47	9/24 - 7/25	0.1260	24/47 - 15/39	10/59 - 2/46
0.0952	2/21	4/42	0.1270	22/43 - 15/39	1/46 + 6/57
0.0960	11/39 - 8/43	11/39 - 8/43	0.1277	6/47	6/47
0.0968	3/31	6/62	0.1280	7/37 - 3/49	33/62 - 19/47
0.0970	22/43 - 17/41	12/59 - 5/47	0.1282	5/39	5/39
0.0976	4/41	4/41	0.1290	10/27 - 7/29	24/59 - 15/54
0.0980	7/27 - 5/31	16/47 - 16/66	0.1290	4/31	8/62

Table 3. (Continued) Accurate Angular Indexing

Part of a Turn	B&S, Becker, Hendeny, K&T, & Rockford	Cincinnati and LeBlond	Part of a Turn	B&S, Becker, Hendeny, K&T, & Rockford	Cincinnati and LeBlond
0.1296	...	7/54	0.1613	5/31	10/62
0.1300	10/43 - 4/39	6/24 - 3/25	0.1620	3/39 + 4/47	25/57 - 13/47
0.1304	3/23	6/46	0.1622	6/37	6/37
0.1310	3/43 + 3/49	8/49 - 2/62	0.1628	7/43	7/43
0.1316	...	5/38	0.1630	10/29 - 6/33	22/47 - 18/59
0.1320	11/47 - 5/49	11/47 - 5/49	0.1633	8/49	8/49
0.1321	...	7/53	0.1640	10/47 - 2/41	8/38 - 2/43
0.1330	8/29 - 3/21	2/37 + 3/38	0.1650	2/47 + 6/49	3/24 + 1/25
0.1333	2/15	4/30	0.1660	8/23 - 6/33	16/46 - 12/66
0.1340	7/17 - 5/18	19/53 - 11/49	0.1667	3/18	4/24
0.1350	10/43 - 4/41	9/24 - 6/25	0.1667	...	5/30
0.1351	5/37	5/37	0.1667	...	7/42
0.1356	...	8/59	0.1667	...	9/54
0.1360	5/16 - 3/17	11/47 - 5/51	0.1667	...	11/66
0.1364	...	9/66	0.1670	16/39 - 9/37	19/53 - 9/47
0.1370	3/41 + 3/47	10/47 - 5/66	0.1680	16/43 - 10/49	26/57 - 17/59
0.1373	...	7/51	0.1690	5/39 + 2/49	10/46 - 3/62
0.1379	4/29	8/58	0.1695	...	10/59
0.1380	23/47 - 13/37	18/39 - 11/34	0.1698	...	9/53
0.1390	28/49 - 16/37	16/38 - 11/39	0.1700	6/23 - 3/33	6/24 - 2/25
0.1395	6/43	6/43	0.1702	8/47	8/47
0.1400	8/49 - 1/43	1/25 + 3/30	0.1707	7/41	7/41
0.1404	...	8/57	0.1710	15/49 - 5/37	15/47 - 8/54
0.1410	11/47 - 4/43	12/66 - 2/49	0.1720	1/39 + 6/41	32/59 - 20/54
0.1420	8/49 - 1/47	21/57 - 12/53	0.1724	5/29	10/58
0.1429	...	4/28	0.1730	9/41 - 2/31	9/41 - 2/43
0.1429	3/21	6/42	0.1739	4/23	8/46
0.1429	7/49	7/49	0.1740	10/33 - 4/31	21/53 - 12/54
0.1430	10/47 - 3/43	24/51 - 19/58	0.1750	2/16 + 1/20	1/24 + 4/30
0.1440	19/43 - 14/47	20/49 - 14/53	0.1754	...	10/57
0.1450	9/47 - 2/43	15/24 - 12/25	0.1760	2/37 + 5/41	2/37 + 5/41
0.1452	...	9/62	0.1765	3/17	6/34
0.1460	26/49 - 15/39	2/47 + 6/58	0.1765	...	9/51
0.1463	6/41	6/41	0.1770	5/39 + 2/41	14/49 - 5/46
0.1470	4/21 - 1/23	16/41 - 9/37	0.1774	...	11/62
0.1471	...	5/34	0.1780	23/41 - 18/47	6/49 + 3/54
0.1480	4/19 - 1/16	9/37 - 4/42	0.1786	...	5/28
0.1481	4/27	8/54	0.1790	11/21 - 10/29	19/51 - 12/62
0.1489	7/47	7/47	0.1795	7/39	7/39
0.1490	12/31 - 5/21	11/49 - 4/53	0.1800	11/47 - 2/37	2/25 + 3/30
0.1500	3/20	7/30 - 2/24	0.1810	11/37 - 5/43	18/38 - 12/41
0.1509	...	8/53	0.1818	6/33	12/66
0.1510	22/47 - 13/41	25/59 - 18/66	0.1820	9/39 - 2/41	21/46 - 14/51
0.1515	5/33	10/66	0.1830	5/17 - 2/18	33/58 - 22/57
0.1520	11/41 - 5/43	16/62	0.1837	9/49	9/49
0.1522	...	7/46	0.1840	8/31 - 2/27	19/62 - 6/49
0.1525	...	9/59	0.1842	...	7/38
0.1530	10/27 - 5/23	13/54 - 5/57	0.1850	4/37 + 3/39	14/25 - 9/24
0.1538	6/39	6/39	0.1852	5/27	10/54
0.1540	10/37 - 5/43	5/58 + 4/59	0.1860	1/29 + 5/33	18/47 - 13/66
0.1550	8/37 - 3/49	7/25 - 3/24	0.1860	8/43	8/43
0.1552	...	9/58	0.1864	...	11/59
0.1560	4/21 - 1/29	1/49 + 8/59	0.1870	16/49 - 6/43	24/57 - 11/47
0.1569	...	8/51	0.1875	3/16	...
0.1570	15/47 - 6/37	31/59 - 21/57	0.1880	12/29 - 7/31	30/49 - 28/66
0.1579	3/19	6/38	0.1887	...	10/53
0.1579	...	9/57	0.1890	13/29 - 7/27	23/58 - 11/53
0.1580	3/37 + 3/39	3/34 + 3/43	0.1892	7/37	7/37
0.1590	20/43 - 15/49	3/54 + 6/58	0.1897	...	11/58
0.1600	18/37 - 16/49	4/25	0.1900	10/43 - 2/47	11/25 - 6/24
0.1610	9/39 - 3/43	9/39 - 3/43	0.1905	4/21	8/42

Table 3. (Continued) Accurate Angular Indexing

Part of a Turn	B&S, Becker, Hendeny, K&T, & Rockford	Cincinnati and LeBlond	Part of a Turn	B&S, Becker, Hendeny, K&T, & Rockford	Cincinnati and LeBlond
0.1910	17/39 - 12/49	21/57 - 11/62	0.2222	4/18	...
0.1915	9/47	9/47	0.2222	6/27	12/54
0.1920	7/41 + 1/47	12/57 - 1/54	0.2230	15/31 - 6/23	11/46 - 1/62
0.1930	...	11/57	0.2240	5/41 + 5/49	15/38 - 7/41
0.1930	10/19 - 5/15	19/59 - 8/62	0.2241	...	13/58
0.1935	6/31	12/62	0.2245	11/49	11/49
0.1940	7/41 + 1/43	14/43 - 5/38	0.2250	2/16 + 2/20	3/24 + 3/30
0.1950	1/23 + 5/33	8/25 - 3/24	0.2258	7/31	14/62
0.1951	8/41	8/41	0.2260	7/39 + 2/43	2/49 + 10/54
0.1957	...	9/46	0.2264	...	12/53
0.1960	21/49 - 10/43	34/66 - 15/47	0.2270	7/27 - 1/31	14/54 - 2/62
0.1961	...	10/51	0.2273	...	15/66
0.1970	...	13/66	0.2280	11/39 - 2/37	23/49 - 14/58
0.1970	21/39 - 14/41	11/47 - 2/54	0.2281	...	13/57
0.1980	2/29 + 4/31	17/49 - 7/47	0.2290	18/39 - 10/43	29/51 - 18/53
0.1990	5/37 + 3/47	27/59 - 15/58	0.2300	7/37 + 2/49	12/25 - 6/24
0.2000	3/15	5/25	0.2308	9/39	9/39
0.2000	4/20	6/30	0.2310	28/49 - 16/47	26/59 - 13/62
0.2010	11/39 - 3/37	8/49 + 2/53	0.2320	20/41 - 11/43	26/57 - 13/58
0.2020	23/41 - 14/39	23/41 - 14/39	0.2326	10/43	10/43
0.2030	2/37 + 7/47	19/62 - 6/58	0.2330	27/47 - 14/41	25/62 - 8/47
0.2034	...	12/59	0.2333	...	7/30
0.2037	...	11/54	0.2340	24/41 - 13/37	2/54 + 13/66
0.2040	12/47 - 2/39	18/51 - 7/47	0.2340	11/47	11/47
0.2041	10/49	10/49	0.2350	11/27 - 5/29	9/25 - 3/24
0.2050	13/37 - 6/41	3/24 + 2/25	0.2353	4/17	8/34
0.2051	8/39	8/39	0.2353	...	12/51
0.2059	...	7/34	0.2360	10/39 - 1/49	29/66 - 12/59
0.2060	15/43 - 7/49	12/53 - 1/49	0.2368	...	9/38
0.2069	6/29	12/58	0.2370	23/37 - 15/39	23/37 - 15/39
0.2070	19/41 - 10/39	19/41 - 10/39	0.2373	...	14/59
0.2075	...	11/53	0.2380	2/43 + 9/47	34/57 - 19/53
0.2080	15/31 - 8/29	13/58 - 1/62	0.2381	5/21	10/42
0.2083	...	5/24	0.2390	24/43 - 15/47	12/62 + 3/66
0.2090	16/33 - 8/29	8/46 + 2/57	0.2391	...	11/46
0.2093	9/43	9/43	0.2400	3/43 + 8/47	6/25
0.2097	...	13/62	0.2407	...	13/54
0.2100	22/37 - 15/39	6/24 - 1/25	0.2410	19/47 - 8/49	17/47 - 7/58
0.2105	4/19	8/38	0.2414	7/29	14/58
0.2105	...	12/57	0.2419	...	15/62
0.2110	22/41 - 14/43	22/41 - 14/43	0.2420	21/37 - 14/43	12/46 - 1/53
0.2120	2/27 - 4/29	4/54 + 8/58	0.2424	8/33	16/66
0.2121	7/33	14/66	0.2430	29/49 - 15/43	4/47 + 9/57
0.2128	10/47	10/47	0.2432	9/37	9/37
0.2130	23/49 - 10/39	2/30 + 6/41	0.2439	10/41	10/41
0.2140	20/37 - 16/49	12/51 - 1/47	0.2440	13/49 - 1/47	30/53 - 19/59
0.2143	...	6/28	0.2449	12/49	12/49
0.2143	...	9/42	0.2450	13/37 - 5/47	3/24 + 3/25
0.2150	11/43 - 2/49	9/24 - 4/25	0.2453	...	13/53
0.2157	...	11/51	0.2456	...	14/57
0.2160	2/23 + 4/31	25/51 - 17/62	0.2460	20/49 - 6/37	11/37 - 2/39
0.2162	8/37	8/37	0.2470	10/37 - 1/43	29/49 - 20/58
0.2170	11/41 - 2/39	28/59 - 17/66	0.2480	4/23 + 2/27	26/49 - 13/46
0.2174	5/23	10/46	0.2490	10/37 - 1/47	17/43 - 6/41
0.2180	3/31 + 4/33	21/59 - 8/58	0.2500	4/16	6/24
0.2190	11/23 - 7/27	3/47 + 9/58	0.2500	5/20	7/28
0.2195	9/41	9/41	0.2510	2/15 + 2/17	34/66 - 14/53
0.2200	4/41 + 6/49	3/25 + 3/30	0.2520	24/43 - 15/49	22/49 - 13/66
0.2203	...	13/59	0.2530	7/37 + 3/47	11/53 + 3/66
0.2210	18/49 - 6/41	21/47 - 14/62	0.2540	26/49 - 13/47	2/46 + 12/57
0.2220	25/41 - 19/49	7/51 + 5/59	0.2542	...	15/59

Table 3. (Continued) Accurate Angular Indexing

Part of a Turn	B&S, Becker, HendeY, K&T, & Rockford	Cincinnati and LeBlond	Part of a Turn	B&S, Becker, HendeY, K&T, & Rockford	Cincinnati and LeBlond
0.2549	...	13/51	0.2857	...	12/42
0.2550	4/21 + 2/31	9/24 - 3/25	0.2857	...	8/28
0.2553	12/47	12/47	0.2860	20/47 - 6/43	20/58 - 3/51
0.2558	11/43	11/43	0.2870	7/41 + 5/43	20/42 - 7/37
0.2560	13/33 - 4/29	9/47 + 4/62	0.2879	...	19/66
0.2564	10/39	10/39	0.2880	19/43 - 6/39	19/43 - 6/39
0.2570	20/39 - 11/43	8/53 + 7/66	0.2881	...	17/59
0.2576	...	17/66	0.2890	1/21 + 7/29	16/46 - 3/51
0.2580	15/29 - 7/27	24/54 - 11/59	0.2895	...	11/38
0.2581	8/31	16/62	0.2900	23/43 - 12/49	6/24 + 1/25
0.2586	...	15/58	0.2903	9/31	18/62
0.2590	24/49 - 9/39	16/42 - 5/41	0.2910	5/39 + 7/43	7/49 + 8/54
0.2593	7/27	14/54	0.2917	...	7/24
0.2600	20/43 - 8/39	4/25 + 3/30	0.2920	9/39 + 3/49	35/57 - 19/59
0.2609	6/23	12/46	0.2927	12/41	12/41
0.2610	15/33 - 6/31	5/53 + 9/54	0.2930	17/39 - 7/49	28/53 - 12/51
0.2619	...	11/42	0.2931	...	17/58
0.2620	18/37 - 11/49	16/51 - 3/58	0.2940	8/21 - 2/23	14/57 + 3/62
0.2630	13/41 - 2/37	13/46 - 1/51	0.2941	5/17	10/34
0.2632	5/19	10/38	0.2941	...	15/51
0.2632	...	15/57	0.2950	18/37 - 9/47	9/24 - 2/25
0.2640	22/47 - 10/49	22/47 - 10/49	0.2960	21/41 - 8/37	29/57 - 10/47
0.2642	...	14/53	0.2963	8/27	16/54
0.2647	...	9/34	0.2970	3/29 + 6/31	13/47 + 1/49
0.2650	8/37 + 2/41	15/24 - 9/25	0.2973	11/37	11/37
0.2653	13/49	13/49	0.2979	14/47	14/47
0.2660	8/27 - 1/33	28/51 - 15/53	0.2980	11/21 - 7/31	12/37 - 1/38
0.2667	...	8/30	0.2982	...	17/57
0.2670	18/37 - 9/41	19/47 - 7/51	0.2990	19/43 - 7/49	19/43 - 4/28
0.2680	8/18 - 3/17	27/49 - 15/53	0.3000	6/20	9/30
0.2683	11/41	11/41	0.3010	1/41 + 13/47	19/54 - 3/59
0.2690	2/18 + 3/19	6/54 + 9/57	0.3019	...	16/53
0.2700	16/27 - 10/31	13/25 - 6/24	0.3020	7/29 + 2/33	23/62 - 4/58
0.2703	10/37	10/37	0.3023	13/43	13/43
0.2710	2/43 + 11/49	1/28 + 8/34	0.3030	15/39 - 4/49	25/57 - 8/59
0.2712	...	16/59	0.3030	10/33	20/66
0.2720	14/37 - 5/47	17/59 - 1/62	0.3040	16/31 - 7/33	33/59 - 12/47
0.2727	9/33	18/66	0.3043	7/23	14/46
0.2730	1/16 + 4/19	18/34 - 10/39	0.3050	1/31 + 9/33	15/24 - 8/25
0.2740	6/41 + 6/47	26/59 - 9/54	0.3051	...	18/59
0.2742	...	17/62	0.3060	17/31 - 8/33	33/54 - 18/59
0.2745	...	14/51	0.3061	15/49	15/49
0.2750	2/16 + 3/20	5/24 + 2/30	0.3065	...	19/62
0.2759	8/29	16/58	0.3070	18/37 - 7/39	1/53 + 17/59
0.2760	12/31 - 3/27	13/43 - 1/38	0.3077	12/39	12/39
0.2766	13/47	13/47	0.3080	5/41 + 8/43	16/49 - 1/54
0.2770	11/27 - 3/23	18/28 - 15/41	0.3090	1/43 + 14/49	19/30 - 12/37
0.2778	5/18	15/54	0.3095	...	13/42
0.2780	5/23 + 2/33	17/39 - 6/38	0.3100	16/37 - 6/49	14/25 - 6/24
0.2790	16/29 - 9/33	14/47 - 1/53	0.3103	9/29	18/58
0.2791	12/43	12/43	0.3110	3/39 + 11/47	19/46 - 5/49
0.2800	16/49 - 2/43	7/25	0.3120	8/21 - 2/29	2/49 + 16/59
0.2807	...	16/57	0.3125	5/16	...
0.2810	3/39 + 10/49	17/57 - 1/58	0.3130	9/37 + 3/43	4/24 + 6/41
0.2820	5/27 + 3/31	24/66 - 4/49	0.3137	...	16/51
0.2821	11/39	11/39	0.3140	12/27 - 3/23	14/47 + 1/62
0.2826	...	13/46	0.3148	...	17/54
0.2830	14/43 - 2/47	15/53	0.3150	26/41 - 15/47	21/24 - 14/25
0.2840	21/47 - 7/43	37/66 - 13/47	0.3158	...	12/38
0.2850	15/43 - 3/47	3/24 + 4/25	0.3158	...	18/57
0.2857	14/49	14/49	0.3160	6/37 + 6/39	6/34 + 6/43

Table 3. (Continued) Accurate Angular Indexing

Part of a Turn	B&S, Becker, Hendeny, K&T, & Rockford	Cincinnati and LeBlond	Part of a Turn	B&S, Becker, Hendeny, K&T, & Rockford	Cincinnati and LeBlond
0.3170	11/18 - 5/17	34/59 - 14/54	0.3485	...	23/66
0.3171	13/41	13/41	0.3488	15/43	15/43
0.3180	22/37 - 13/47	6/54 + 12/58	0.3490	11/29 - 1/33	2/47 + 19/62
0.3182	...	21/66	0.3500	7/20	6/24 + 3/30
0.3190	6/27 + 3/31	3/34 + 9/39	0.3509	...	20/57
0.3191	15/47	15/47	0.3510	13/27 - 3/23	25/53 - 7/58
0.3200	16/47 - 1/49	8/25	0.3514	13/37	13/37
0.3208	...	17/53	0.3519	...	19/54
0.3210	25/49 - 7/37	10/59 + 10/66	0.3520	4/37 + 10/41	24/62 - 2/57
0.3214	...	9/28	0.3529	6/17	12/34
0.3220	18/39 - 6/43	18/39 - 6/43	0.3529	...	18/51
0.3220	...	19/59	0.3530	4/37 + 12/49	31/59 - 10/58
0.3226	10/31	20/62	0.3540	14/37 - 1/41	22/59 - 1/53
0.3230	21/41 - 7/37	21/41 - 7/37	0.3548	11/31	22/62
0.3235	...	11/34	0.3550	10/43 + 6/49	12/25 - 3/24
0.3240	3/23 + 6/31	21/47 - 7/57	0.3559	...	21/59
0.3243	12/37	12/37	0.3560	5/41 + 11/47	12/49 + 6/54
0.3250	2/16 + 4/20	3/24 + 5/25	0.3570	20/43 - 4/37	20/43 - 4/37
0.3256	14/43	14/43	0.3571	...	10/28
0.3260	21/49 - 4/39	23/59 - 3/47	0.3571	...	15/42
0.3261	...	15/46	0.3580	14/37 - 1/49	38/62 - 13/51
0.3265	16/49	16/49	0.3585	...	19/53
0.3270	24/49 - 7/43	17/58 + 2/59	0.3590	14/39	14/39
0.3276	...	19/58	0.3600	22/47 - 4/37	9/25
0.3280	26/41 - 15/49	15/51 + 2/59	0.3610	9/23 - 1/33	18/46 - 2/66
0.3290	5/21 + 3/33	23/43 - 7/34	0.3617	17/47	17/47
0.3300	4/47 + 12/49	6/24 + 2/25	0.3620	15/27 - 6/31	17/41 - 2/38
0.3310	17/31 - 5/23	23/59 - 3/51	0.3621	...	21/58
0.3320	28/43 - 15/47	30/59 - 9/51	0.3630	23/49 - 5/47	25/53 - 5/46
0.3330	7/43 + 8/47	36/51 - 22/59	0.3636	12/33	24/66
0.3333	5/15	8/24	0.3640	26/47 - 7/37	25/62 - 2/51
0.3333	6/18	10/30	0.3650	28/47 - 9/39	3/24 + 6/25
0.3333	7/21	13/39	0.3659	...	15/41
0.3333	9/27	14/42	0.3660	10/17 - 4/18	13/57 + 8/58
0.3333	11/33	17/51	0.3667	...	11/30
0.3333	13/39	18/54	0.3670	5/27 + 6/33	13/49 + 6/59
0.3333	...	19/57	0.3673	18/49	18/49
0.3333	...	22/66	0.3680	16/31 - 4/27	31/66 - 6/59
0.3340	7/41 + 8/49	29/47 - 15/53	0.3684	7/19	14/38
0.3350	21/37 - 10/43	9/24 - 1/25	0.3684	...	21/57
0.3360	28/41 - 17/49	9/46 + 8/57	0.3690	30/49 - 9/37	21/62 + 2/66
0.3370	2/39 + 14/49	33/57 - 15/62	0.3696	...	17/46
0.3380	10/23 - 3/31	25/62 - 3/46	0.3700	30/47 - 11/41	6/24 + 3/25
0.3387	...	21/62	0.3704	10/27	20/54
0.3390	19/49 - 2/41	20/59	0.3710	32/49 - 11/39	23/62
0.3396	...	18/53	0.3720	2/29 + 10/33	34/57 - 11/49
0.3400	25/49 - 8/47	6/25 + 3/30	0.3721	16/43	16/43
0.3404	16/47	16/47	0.3725	...	19/51
0.3410	12/27 - 3/29	22/46 - 7/51	0.3729	...	22/59
0.3415	14/41	14/41	0.3730	30/47 - 13/49	21/49 - 3/54
0.3420	4/21 + 5/33	25/62 - 3/49	0.3740	32/49 - 12/43	5/46 + 13/49
0.3421	...	13/38	0.3750	6/16	9/24
0.3430	13/23 - 6/27	37/57 - 15/49	0.3760	5/21 + 4/29	11/49 + 10/66
0.3440	2/39 + 12/41	14/54 + 5/59	0.3770	13/37 + 1/39	20/51 - 1/66
0.3448	...	20/58	0.3774	...	20/53
0.3450	2/23 + 8/31	15/24 - 7/25	0.3780	13/27 - 3/29	31/53 - 12/58
0.3460	18/41 - 4/43	18/41 - 4/43	0.3784	14/37	14/37
0.3469	17/49	17/49	0.3788	...	25/66
0.3470	7/31 + 4/33	7/38 + 7/43	0.3790	8/37 + 7/43	8/37 + 7/43
0.3478	8/23	16/46	0.3793	11/29	22/58
0.3480	20/33 - 8/31	31/59 - 11/62	0.3800	20/43 - 4/47	7/25 + 3/30

Table 3. (Continued) Accurate Angular Indexing

Part of a Turn	B&S, Becker, Hendey, K&T, & Rockford	Cincinnati and LeBlond	Part of a Turn	B&S, Becker, Hendey, K&T, & Rockford	Cincinnati and LeBlond
0.3810	8/21	16/42	0.4120	18/41 - 1/37	24/53 - 2/49
0.3810	19/47 - 1/43	8/51 + 13/58	0.4130	2/39 + 17/47	19/46
0.3820	25/49 - 5/39	40/62 - 15/57	0.4138	12/29	24/58
0.3824	...	13/34	0.4140	19/39 - 3/41	19/39 - 3/41
0.3830	18/47	18/47	0.4146	17/41	17/41
0.3830	27/43 - 12/49	37/58 - 13/51	0.4150	18/33 - 3/23	9/24 + 1/25
0.3840	27/43 - 10/41	27/43 - 10/41	0.4151	...	22/53
0.3846	15/39	15/39	0.4160	21/39 - 6/49	41/62 - 13/53
0.3850	15/37 - 1/49	15/24 - 6/25	0.4167	...	10/24
0.3860	1/37 + 14/39	22/57	0.4170	26/37 - 14/49	10/38 + 6/39
0.3870	3/17 + 4/19	16/39 - 1/43	0.4180	8/21 + 1/27	16/46 + 4/57
0.3871	12/31	24/62	0.4186	18/43	18/43
0.3878	19/49	19/49	0.4190	18/39 - 2/47	31/46 - 13/51
0.3880	14/41 + 2/43	18/53 + 3/62	0.4194	13/31	26/62
0.3889	7/18	21/54	0.4200	24/49 - 3/43	8/25 + 3/30
0.3890	17/41 - 1/39	24/53 - 3/47	0.4210	1/39 + 17/43	23/49 - 3/62
0.3898	...	23/59	0.4211	8/19	16/38
0.3900	2/23 + 10/33	16/25 - 6/24	0.4211	...	24/57
0.3902	16/41	16/41	0.4220	15/29 - 2/21	3/41 + 15/43
0.3910	14/31 - 2/33	29/66 - 3/62	0.4230	24/43 - 5/37	20/54 + 3/57
0.3913	9/23	18/46	0.4237	...	25/59
0.3920	14/33 - 1/31	17/47 + 2/66	0.4240	4/27 + 8/29	41/62 - 14/59
0.3922	...	20/51	0.4242	14/33	28/66
0.3929	...	11/28	0.4250	6/16 + 1/20	7/24 + 4/30
0.3930	1/39 + 18/49	28/46 - 11/51	0.4255	20/47	20/47
0.3939	13/33	26/66	0.4259	...	23/54
0.3940	3/39 + 13/41	24/53 - 3/51	0.4260	27/41 - 10/43	28/57 - 3/46
0.3947	...	15/38	0.4270	27/39 - 13/49	29/59 - 4/62
0.3950	26/37 - 12/39	13/25 - 3/24	0.4280	12/43 + 7/47	33/57 - 8/53
0.3953	17/43	17/43	0.4286	9/21	12/28
0.3960	4/29 + 8/31	33/47 - 15/49	0.4286	21/49	18/42
0.3962	...	21/53	0.4286	...	21/49
0.3966	...	23/58	0.4290	30/47 - 9/43	21/51 + 1/58
0.3970	25/41 - 10/47	7/57 + 17/62	0.4300	22/43 - 4/49	17/25 - 6/24
0.3980	3/16 + 4/19	28/58 - 5/59	0.4310	11/39 + 7/47	25/58
0.3990	7/39 + 9/41	6/37 + 9/38	0.4314	...	22/51
0.4000	6/15	10/25	0.4320	4/23 + 8/31	28/62 - 1/51
0.4000	8/20	12/30	0.4324	16/37	16/37
0.4010	2/37 + 17/49	27/62 - 2/58	0.4330	5/37 + 14/47	26/42 - 8/43
0.4020	5/43 + 14/49	16/49 + 4/53	0.4333	...	13/30
0.4030	26/49 - 6/47	30/47 - 12/51	0.4340	5/31 + 9/33	23/53
0.4032	...	25/62	0.4348	10/23	20/46
0.4035	...	23/57	0.4350	21/31 - 8/33	14/25 - 3/24
0.4040	11/39 + 5/41	11/39 + 5/41	0.4355	...	27/62
0.4043	19/47	19/47	0.4359	...	17/39
0.4048	...	17/42	0.4360	6/31 + 8/33	42/59 - 16/58
0.4050	29/41 - 13/43	3/24 + 7/25	0.4370	27/39 - 12/47	31/49 - 9/46
0.4054	15/37	15/37	0.4375	7/16	...
0.4060	21/47 - 2/49	17/58 + 7/62	0.4380	13/27 - 1/23	24/57 + 1/59
0.4068	...	24/59	0.4386	...	25/57
0.4070	9/19 - 1/15	7/47 + 16/62	0.4390	18/43 + 1/49	34/59 - 7/51
0.4074	11/27	22/54	0.4390	18/41	18/41
0.4080	16/37 - 1/41	2/54 + 23/62	0.4394	...	29/66
0.4082	20/49	20/49	0.4400	8/41 + 12/49	11/25
0.4090	15/39 + 1/41	15/39 + 1/41	0.4407	...	26/59
0.4091	...	27/66	0.4410	10/37 + 7/41	10/37 + 7/41
0.4100	1/37 + 18/47	6/24 + 4/25	0.4412	...	15/34
0.4103	16/39	16/39	0.4419	19/43	19/43
0.4110	9/41 + 9/47	7/34 + 8/39	0.4420	18/33 - 3/29	34/62 - 5/47
0.4118	7/17	14/34	0.4430	4/39 + 16/47	20/51 + 3/59
0.4118	...	21/51	0.4440	9/41 + 11/49	14/51 + 10/59

Table 3. (Continued) Accurate Angular Indexing

Part of a Turn	B&S, Becker, Hendeny, K&T, & Rockford	Cincinnati and LeBlond	Part of a Turn	B&S, Becker, Hendeny, K&T, & Rockford	Cincinnati and LeBlond
0.4444	12/27	24/54	0.4737	...	27/57
0.4444	8/18	...	0.4740	9/37 + 9/39	9/34 + 9/43
0.4450	7/37 + 11/43	3/24 + 8/25	0.4746	...	28/59
0.4460	11/23 - 1/31	22/46 - 2/62	0.4750	6/16 + 2/20	9/24 + 3/30
0.4468	21/47	21/47	0.4760	4/43 + 18/47	15/53 + 11/57
0.4470	6/21 + 5/31	14/49 + 10/62	0.4762	10/21	20/42
0.4474	...	17/38	0.4770	26/43 - 6/47	30/47 - 10/62
0.4480	10/41 + 10/49	27/41 - 8/38	0.4780	12/31 + 3/33	24/62 + 6/66
0.4483	13/29	26/58	0.4783	11/23	22/46
0.4490	22/49	22/49	0.4790	22/39 - 4/47	10/53 + 18/62
0.4490	20/39 - 3/47	14/57 + 12/59	0.4800	16/39 + 3/43	12/25
0.4500	9/20	6/24 + 6/30	0.4810	14/41 + 6/43	22/58 + 6/59
0.4510	...	23/51	0.4815	13/27	26/54
0.4510	5/15 + 2/17	42/62 - 12/53	0.4820	33/49 - 9/47	19/46 + 4/58
0.4516	14/31	28/62	0.4828	14/29	28/58
0.4520	14/39 + 4/43	4/49 + 20/54	0.4830	27/39 - 9/43	27/39 - 9/43
0.4524	...	19/42	0.4839	15/31	30/62
0.4528	...	24/53	0.4840	5/37 + 15/43	24/46 - 2/53
0.4530	3/23 + 10/31	16/59 + 12/66	0.4848	16/33	32/66
0.4540	14/27 - 2/31	1/54 + 27/62	0.4850	24/47 - 1/39	3/24 + 9/25
0.4545	15/33	30/66	0.4860	13/43 + 9/49	43/62 - 11/53
0.4550	25/47 - 3/39	9/24 + 2/25	0.4865	18/37	18/37
0.4560	9/37 + 10/47	17/62 + 12/66	0.4870	15/37 + 4/49	26/43 - 4/34
0.4561	...	26/57	0.4872	19/39	19/39
0.4565	...	21/46	0.4878	20/41	20/41
0.4570	4/37 + 15/43	27/39 - 8/34	0.4880	8/29 + 7/33	5/46 + 22/58
0.4576	...	27/59	0.4884	21/43	21/43
0.4580	27/49 - 4/43	20/53 + 5/62	0.4890	28/43 - 6/37	19/47 + 5/59
0.4583	...	11/24	0.4894	23/47	23/47
0.4590	35/49 - 12/47	18/51 + 7/66	0.4898	24/49	24/49
0.4595	17/37	17/37	0.4900	13/21 - 4/31	6/24 + 6/25
0.4600	16/41 + 3/43	9/25 + 3/30	0.4902	...	25/51
0.4610	13/39 + 6/47	22/34 - 8/43	0.4906	...	26/53
0.4615	18/39	18/39	0.4910	15/39 + 5/47	21/46 + 2/58
0.4620	15/47 + 7/49	36/62 - 7/59	0.4912	...	28/57
0.4630	...	25/54	0.4915	...	29/59
0.4630	...	10/46 + 14/57	0.4920	25/37 - 9/49	17/46 + 6/49
0.4631	9/21 + 1/29	...	0.4930	8/41 + 14/47	21/53 + 6/62
0.4634	19/41	19/41	0.4940	33/49 - 7/39	14/46 + 11/58
0.4640	21/43 - 1/41	32/58 - 5/57	0.4950	5/29 + 10/31	9/24 + 3/25
0.4643	...	13/28	0.4960	8/23 + 4/27	20/53 + 7/59
0.4650	21/37 - 4/39	15/24 - 4/25	0.4970	33/47 - 8/39	7/46 + 20/58
0.4651	20/43	20/43	0.4980	20/37 - 2/47	29/41 - 9/43
0.4655	...	27/58	0.4990	26/41 - 5/37	26/41 - 5/37
0.4660	13/41 + 7/47	31/47 - 12/62	0.5000	8/16	12/24
0.4667	7/15	14/30	0.5000	9/18	14/28
0.4670	19/37 - 2/43	25/34 - 11/41	0.5000	10/20	15/30
0.4677	...	29/62	0.5000	...	17/34
0.4680	11/27 + 2/33	3/49 + 24/59	0.5000	...	19/38
0.4681	22/47	22/47	0.5000	...	21/42
0.4690	8/23 + 4/33	35/49 - 13/53	0.5000	...	23/46
0.4694	23/49	23/49	0.5000	...	27/54
0.4697	...	31/66	0.5000	...	29/58
0.4700	19/29 - 5/27	18/25 - 6/24	0.5000	...	31/62
0.4706	8/17	16/34	0.5000	...	33/66
0.4706	...	24/51	0.5010	5/37 + 15/41	37/51 - 11/49
0.4710	12/39 + 8/49	12/47 + 11/51	0.5020	17/37 + 2/47	25/53 + 2/66
0.4717	...	25/53	0.5030	8/39 + 14/47	16/49 + 9/51
0.4720	20/39 - 2/49	31/53 - 7/62	0.5040	5/43 + 19/49	37/66 - 3/53
0.4730	6/39 + 15/47	29/59 - 1/54	0.5050	21/31 - 5/29	15/24 - 3/25
0.4737	9/19	18/38	0.5060	7/39 + 16/49	22/53 + 6/66

Table 3. (Continued) Accurate Angular Indexing

Part of a Turn	B&S, Becker, Hendeny, K&T, & Rockford	Cincinnati and LeBlond	Part of a Turn	B&S, Becker, Hendeny, K&T, & Rockford	Cincinnati and LeBlond
0.5070	33/47 – 8/41	28/46 – 6/59	0.5370	...	29/54
0.5080	12/37 + 9/49	41/66 – 6/53	0.5370	...	6/51 + 26/62
0.5085	...	30/59	0.5371	17/41 + 6/49	...
0.5088	...	29/57	0.5380	4/18 + 6/19	12/49 + 17/58
0.5090	24/39 – 5/47	27/51 – 1/49	0.5385	21/39	21/39
0.5094	...	27/53	0.5390	26/39 – 6/47	34/51 – 6/47
0.5098	...	26/51	0.5400	25/41 – 3/43	6/25 + 9/30
0.5100	8/21 + 4/31	18/24 – 6/25	0.5405	20/37	20/37
0.5102	25/49	25/49	0.5410	12/47 + 14/49	2/38 + 21/43
0.5106	24/47	24/47	0.5417	...	13/24
0.5110	6/37 + 15/43	26/49 – 1/51	0.5420	4/43 + 22/49	7/46 + 23/59
0.5116	22/43	22/43	0.5424	...	32/59
0.5120	21/29 – 7/33	45/66 – 9/53	0.5430	33/43 – 11/49	22/54 + 8/59
0.5122	21/41	21/41	0.5435	...	25/46
0.5128	20/39	20/39	0.5439	...	31/57
0.5130	22/37 – 4/49	30/54 – 2/47	0.5440	4/37 + 17/39	4/37 + 17/39
0.5135	19/37	19/37	0.5450	3/39 + 22/47	15/24 – 2/25
0.5140	30/43 – 9/49	33/46 – 12/59	0.5455	18/33	36/66
0.5150	1/39 + 23/47	16/25 – 3/24	0.5460	13/27 + 2/31	2/34 + 19/39
0.5152	17/33	34/66	0.5470	21/31 – 3/23	32/49 – 7/66
0.5160	28/43 – 5/37	37/59 – 6/54	0.5472	...	29/53
0.5161	16/31	32/62	0.5476	...	23/42
0.5170	13/39 + 9/49	9/49 + 17/51	0.5480	12/41 + 12/47	25/39 – 4/43
0.5172	15/29	30/58	0.5484	17/31	34/62
0.5180	9/47 + 16/49	31/41 – 10/42	0.5490	10/15 – 2/17	8/47 + 25/66
0.5185	14/27	28/54	0.5490	...	28/51
0.5190	27/41 – 6/43	6/49 + 23/58	0.5500	11/20	6/24 + 9/30
0.5200	3/41 + 21/47	13/25	0.5510	19/39 + 3/47	31/53 – 2/59
0.5210	17/39 + 4/47	41/59 – 8/46	0.5510	...	27/49
0.5217	12/23	24/46	0.5517	16/29	32/58
0.5220	19/31 – 3/33	14/47 + 13/58	0.5520	31/41 – 10/49	29/46 – 4/51
0.5230	17/43 + 6/47	14/49 + 14/59	0.5526	...	21/38
0.5238	11/21	22/42	0.5530	15/21 – 5/31	28/54 + 2/58
0.5240	29/47 – 4/43	32/51 – 6/58	0.5532	26/47	26/47
0.5250	6/16 + 3/20	7/24 + 7/30	0.5540	12/23 + 1/31	12/53 + 19/58
0.5254	...	31/59	0.5550	1/41 + 26/49	17/25 – 3/24
0.5260	28/37 – 9/39	26/46 – 2/51	0.5556	10/18	30/54
0.5263	10/19	20/38	0.5556	15/27	...
0.5263	...	30/57	0.5560	32/41 – 11/49	35/47 – 10/53
0.5270	32/47 – 6/39	6/53 + 24/58	0.5570	22/41 + 1/49	18/49 + 11/58
0.5280	19/39 + 2/49	35/59 – 3/46	0.5580	3/29 + 15/33	7/53 + 23/54
0.5283	...	28/53	0.5581	24/43	24/43
0.5290	18/37 + 2/47	30/53 – 2/54	0.5588	...	19/34
0.5294	9/17	18/34	0.5590	27/37 – 7/41	43/59 – 9/53
0.5294	...	27/51	0.5593	...	33/59
0.5300	5/27 + 10/29	6/24 + 7/25	0.5600	37/49 – 8/41	14/25
0.5303	...	35/66	0.5606	...	37/66
0.5306	26/49	26/49	0.5610	23/41	23/41
0.5310	15/23 – 4/33	24/37 – 4/34	0.5610	4/23 + 12/31	5/51 + 25/54
0.5319	25/47	25/47	0.5614	...	32/57
0.5320	7/27 + 9/33	5/51 + 23/53	0.5620	1/23 + 14/27	9/34 + 11/37
0.5323	...	33/62	0.5625	9/16	...
0.5330	18/37 + 2/43	16/46 + 10/54	0.5630	12/39 + 12/47	22/46 + 5/59
0.5333	8/15	16/30	0.5640	25/33 – 6/31	41/49 – 18/66
0.5340	28/41 – 7/47	37/51 – 9/47	0.5641	22/39	22/39
0.5345	...	31/58	0.5645	...	35/62
0.5349	23/43	23/43	0.5650	10/31 + 8/33	3/24 + 11/25
0.5350	16/37 + 4/39	9/24 + 4/25	0.5652	13/23	26/46
0.5357	...	15/28	0.5660	4/39 + 19/41	9/46 + 20/54
0.5360	1/41 + 22/43	5/49 + 23/53	0.5660	...	30/53
0.5366	22/41	22/41	0.5667	...	17/30

Table 3. (Continued) Accurate Angular Indexing

Part of a Turn	B&S, Becker, Hendeny, K&T, & Rockford	Cincinnati and LeBlond	Part of a Turn	B&S, Becker, Hendeny, K&T, & Rockford	Cincinnati and LeBlond
0.5670	33/47 – 5/37	25/47 + 2/57	0.5970	6/47 + 23/49	13/58 + 22/59
0.5676	21/37	21/37	0.5980	35/49 – 5/43	16/47 + 17/66
0.5680	23/31 – 4/23	21/47 + 8/66	0.5990	17/37 + 6/43	23/49 + 7/54
0.5686	...	29/51	0.6000	9/15	15/25
0.5690	...	33/58	0.6000	12/20	18/30
0.5690	28/39 – 7/47	42/59 – 7/49	0.6010	32/41 – 7/39	32/41 – 7/39
0.5700	21/43 + 4/49	6/24 + 8/25	0.6020	13/16 – 4/19	20/47 + 9/51
0.5710	9/43 + 17/47	39/57 – 6/53	0.6030	16/41 + 10/47	24/49 + 6/53
0.5714	12/21	16/28	0.6034	...	35/58
0.5714	28/49	24/42	0.6038	...	32/53
0.5714	...	28/49	0.6040	23/31 – 4/29	21/58 + 15/62
0.5720	31/43 – 7/47	40/58 – 6/51	0.6047	...	26/43
0.5730	12/39 + 13/49	23/57 + 10/59	0.6050	11/37 + 12/39	3/24 + 12/25
0.5740	14/41 + 10/43	23/37 – 2/42	0.6053	...	23/38
0.5741	...	31/54	0.6060	28/41 – 3/39	29/54 + 4/58
0.5745	27/47	27/47	0.6061	20/33	40/66
0.5750	3/15 + 6/16	9/24 + 6/30	0.6070	31/49 – 1/39	23/47 + 6/51
0.5758	19/33	38/66	0.6071	...	17/28
0.5760	21/29 – 4/27	24/49 + 5/58	0.6078	...	31/51
0.5763	...	34/59	0.6080	1/31 + 19/33	24/53 + 9/58
0.5770	5/37 + 19/43	32/46 – 7/59	0.6087	14/23	28/46
0.5780	2/21 + 14/29	25/49 + 4/59	0.6090	17/31 + 2/33	40/59 – 4/58
0.5789	11/19	22/38	0.6098	25/41	25/41
0.5789	...	33/57	0.6100	23/33 – 2/23	6/24 + 9/25
0.5790	26/43 – 1/39	38/62 – 2/59	0.6102	...	36/59
0.5800	3/43 + 25/49	12/25 + 3/30	0.6110	1/39 + 24/41	5/28 + 16/37
0.5806	18/31	36/62	0.6111	...	33/54
0.5810	21/39 + 2/47	18/53 + 14/58	0.6120	27/41 – 2/43	29/39 – 5/38
0.5814	25/43	25/43	0.6122	30/49	30/49
0.5820	6/21 + 8/27	23/38 – 1/43	0.6129	19/31	38/62
0.5830	11/37 + 14/49	8/46 + 27/66	0.6130	15/19 – 3/17	1/49 + 32/54
0.5833	...	14/24	0.6140	25/39 – 1/37	36/49 – 7/58
0.5840	18/39 + 6/49	13/57 + 21/59	0.6140	...	35/57
0.5849	...	31/53	0.6150	22/37 + 1/49	9/24 + 6/25
0.5850	3/23 + 15/33	15/24 – 1/25	0.6154	24/39	24/39
0.5854	24/41	24/41	0.6160	10/41 + 16/43	14/53 + 19/54
0.5860	20/39 + 3/41	17/54 + 16/59	0.6170	12/37 + 12/41	5/59 + 33/62
0.5862	17/29	34/58	0.6170	29/47	29/47
0.5870	...	27/46	0.6176	...	21/34
0.5870	30/47 – 2/39	37/53 – 6/54	0.6180	5/39 + 24/49	3/53 + 32/57
0.5880	1/37 + 23/41	28/57 + 6/62	0.6190	1/43 + 28/47	17/53 + 17/57
0.5882	10/17	20/34	0.6190	13/21	26/42
0.5882	...	30/51	0.6200	23/43 + 4/47	8/25 + 9/30
0.5890	32/41 – 9/47	8/46 + 22/53	0.6207	...	36/58
0.5897	23/39	23/39	0.6210	29/37 – 7/43	6/46 + 26/53
0.5900	29/47 – 1/37	18/24 – 4/25	0.6212	...	41/66
0.5909	...	39/66	0.6216	23/37	23/37
0.5910	24/39 – 1/41	40/59 – 4/46	0.6220	14/27 + 3/29	15/53 + 20/59
0.5918	29/49	29/49	0.6226	...	33/53
0.5920	21/37 + 1/41	21/34 – 1/39	0.6230	24/37 – 1/39	24/37 – 1/39
0.5926	16/27	32/54	0.6240	5/29 + 14/31	4/49 + 32/59
0.5930	1/15 + 10/19	22/34 – 2/37	0.6250	10/16	15/24
0.5932	...	35/59	0.6260	12/43 + 17/49	21/46 + 10/59
0.5940	6/29 + 12/31	15/49 + 19/66	0.6270	17/47 + 13/49	24/46 + 6/57
0.5946	22/37	22/37	0.6271	...	37/59
0.5950	12/41 + 13/43	18/25 – 3/24	0.6275	...	32/51
0.5952	...	25/42	0.6279	27/43	27/43
0.5957	28/47	28/47	0.6280	23/33 – 2/29	28/47 + 2/62
0.5960	28/39 – 5/41	15/51 + 16/53	0.6290	11/39 + 17/49	12/54 + 24/59
0.5965	...	34/57	0.6290	...	39/62
0.5968	...	37/62	0.6296	17/27	34/54

Table 3. (Continued) Accurate Angular Indexing

Part of a Turn	B&S, Becker, Hendeny, K&T, & Rockford	Cincinnati and LeBlond	Part of a Turn	B&S, Becker, Hendeny, K&T, & Rockford	Cincinnati and LeBlond
0.6300	11/41 + 17/47	18/24 - 3/25	0.6610	...	39/59
0.6304	...	29/46	0.6613	...	41/62
0.6310	9/37 + 19/49	8/49 + 29/62	0.6620	13/23 + 3/31	36/53 - 1/58
0.6316	12/19	24/38	0.6630	35/49 - 2/39	11/39 + 16/42
0.6316	...	36/57	0.6640	13/41 + 17/49	33/51 + 1/59
0.6320	12/37 + 12/39	12/34 + 12/43	0.6650	16/37 + 10/43	15/24 + 1/25
0.6327	31/49	31/49	0.6660	34/41 - 8/49	21/51 + 15/59
0.6330	13/27 + 5/33	14/51 + 19/53	0.6667	10/15	16/24
0.6333	...	19/30	0.6667	12/18	20/30
0.6340	7/17 + 4/18	25/37 - 1/24	0.6667	14/21	26/39
0.6341	26/41	26/41	0.6667	18/27	28/42
0.6350	9/39 + 19/47	19/25 - 3/24	0.6667	22/33	34/51
0.6360	7/37 + 21/47	12/54 + 24/58	0.6667	26/39	36/54
0.6364	21/33	42/66	0.6667	...	38/57
0.6370	5/47 + 26/49	10/47 + 28/66	0.6667	...	44/66
0.6379	...	37/58	0.6670	24/41 + 4/49	5/51 + 33/58
0.6380	12/27 + 6/31	6/34 + 18/39	0.6680	14/41 + 16/49	11/47 + 23/53
0.6383	30/47	30/47	0.6690	5/23 + 14/31	10/46 + 28/62
0.6390	14/23 + 1/33	28/39 - 3/38	0.6700	37/49 - 4/47	18/24 - 2/25
0.6400	4/37 + 25/47	16/25	0.6710	9/21 + 8/33	15/47 + 19/54
0.6410	...	45/66 - 2/49	0.6720	15/41 + 15//49	7/54 + 32//59
0.6410	25/39	25/39	0.6724	...	39/58
0.6415	...	34/53	0.6730	7/43 + 25//49	42/57 - 3//47
0.6420	23/37 + 1/49	20/59 + 20/66	0.6735	33/49	33/49
0.6429	...	18/28	0.6739	...	31/46
0.6429	...	27/42	0.6740	4/39 + 28/49	21/53 + 15/54
0.6430	41/37 - 20/43	24/51 + 10/58	0.6744	29/43	29/43
0.6440	31/43 - 3/39	31/43 - 3/39	0.6750	10/16 + 1/20	9/24 + 9/30
0.6441	...	38/59	0.6757	25/37	25/37
0.6450	33/43 - 6/49	3/24 + 13/25	0.6760	20/23 - 6/31	43/62 - 1/57
0.6452	20/31	40/62	0.6765	...	23/34
0.6460	23/37 + 1/41	2/47 + 35/58	0.6770	7/37 + 20/41	26/53 + 11/59
0.6470	8/39 + 19/43	24/47 + 9/66	0.6774	21/31	42/62
0.6471	11/17	22/34	0.6780	...	40/59
0.6471	...	33/51	0.6780	21/39 + 6/43	6/49 + 30/54
0.6480	31/41 - 4/37	43/57 - 5/47	0.6786	...	19/28
0.6481	...	35/54	0.6790	7/37 + 24/49	19/51 + 19/62
0.6486	24/37	24/37	0.6792	...	36/53
0.6490	3/23 + 14/27	8/30 + 13/34	0.6800	31/47 + 1/49	17/25
0.6491	...	37/57	0.6809	32/47	32/47
0.6500	13/20	6/24 + 12/30	0.6810	21/27 - 3/31	29/41 - 1/38
0.6510	18/29 + 1/33	25/59 + 15/66	0.6818	...	45/66
0.6512	...	28/43	0.6820	15/37 + 13/47	37/51 - 2/46
0.6515	...	43/66	0.6829	28/41	28/41
0.6520	8/31 + 13/33	46/59 - 6/47	0.6830	5/17 + 7/18	35/57 + 4/58
0.6522	15/23	30/46	0.6840	31/37 - 6/39	13/47 + 22/54
0.6530	24/31 - 4/33	22/54 + 14/57	0.6842	13/19	26/38
0.6531	32/49	32/49	0.6842	...	39/57
0.6540	23/41 + 4/43	34/58 + 4/59	0.6850	15/41 + 15/47	3/24 + 14/25
0.6550	23/31 - 2/23	9/24 + 7/25	0.6852	...	37/54
0.6552	19/29	38/58	0.6860	3/23 + 15/27	19/49 + 17/57
0.6560	29/41 - 2/39	23/24 - 13/43	0.6863	...	35/51
0.6570	10/23 + 6/27	20/46 + 12/54	0.6870	28/37 - 3/43	36/51 - 1/53
0.6579	...	25/38	0.6875	11/16	...
0.6580	10/21 + 6/33	20/34 + 3/43	0.6880	13/21 + 2/29	30/49 + 5/66
0.6585	27/41	27/41	0.6890	36/47 - 3/39	42/53 - 6/58
0.6590	15/27 + 3/29	3/54 + 35/58	0.6897	20/29	40/58
0.6596	31/47	31/47	0.6900	21/37 + 6/49	6/24 + 11/25
0.6600	8/47 + 24/49	9/25 + 9/30	0.6905	...	29/42
0.6604	...	35/53	0.6910	35/49 - 1/43	21/57 + 20/62
0.6610	2/41 + 30/49	34/57 + 4/62	0.6920	35/43 - 5/41	35/43 - 5/41

Table 3. (Continued) Accurate Angular Indexing

Part of a Turn	B&S, Becker, Hendeny, K&T, & Rockford	Cincinnati and LeBlond	Part of a Turn	B&S, Becker, Hendeny, K&T, & Rockford	Cincinnati and LeBlond
0.6923	27/39	27/39	0.7234	...	34/47
0.6930	19/37 + 7/39	19/37 + 7/39	0.7240	3/27 + 19/31	34/41 - 4/38
0.6935	...	43/62	0.7241	21/29	42/58
0.6939	34/49	34/49	0.7250	2/16 + 12/20	7/24 + 13/30
0.6940	10/23 + 7/27	14/38 + 14/43	0.7255	...	37/51
0.6949	...	41/59	0.7258	...	45/62
0.6950	24/33 - 1/31	9/24 + 8/25	0.7260	34/41 - 6/47	2/49 + 37/54
0.6957	16/23	32/46	0.7270	15/19 - 1/16	14/54 + 29/62
0.6960	15/31 + 7/33	32/47 + 1/66	0.7273	24/33	48/66
0.6970	...	46/66	0.7280	23/37 + 5/47	23/49 + 15/58
0.6970	24/39 + 4/49	24/51 + 12/53	0.7288	...	43/59
0.6977	30/43	30/43	0.7290	38/49 - 2/43	12/47 + 27/57
0.6980	22/29 - 2/33	4/47 + 38/62	0.7297	27/37	27/37
0.6981	...	37/53	0.7300	11/27 + 10/31	6/24 + 12/25
0.6990	34/47 - 1/41	14/58 + 27/59	0.7310	15/37 + 14/43	26/59 + 18/62
0.7000	14/20	21/30	0.7317	30/41	30/41
0.7010	24/43 + 7/49	28/47 + 6/57	0.7320	20/37 + 9/47	26/57 + 16/58
0.7018	...	40/57	0.7330	19/37 + 9/41	39/47 - 6/62
0.7020	10/21 + 7/31	7/37 + 20/39	0.7333	11/15	22/30
0.7021	33/47	33/47	0.7340	6/21 + 13/29	26/49 + 12/59
0.7027	26/37	26/37	0.7347	36/49	36/49
0.7030	25/31 - 3/29	23/58 + 19/62	0.7350	29/37 - 2/41	9/24 + 9/25
0.7037	19/27	38/54	0.7353	...	25/34
0.7040	8/37 + 20/41	47/59 - 5/54	0.7358	...	39/53
0.7050	19/37 + 9/47	15/24 + 2/25	0.7360	25/47 + 10/49	47/59 - 4/66
0.7059	12/17	24/34	0.7368	14/19	28/38
0.7059	...	36/51	0.7368	...	42/57
0.7060	18/37 + 9/41	38/58 + 3/59	0.7370	2/37 + 28/41	13/49 + 25/53
0.7069	...	41/58	0.7380	19/37 + 11/49	31/47 + 4/51
0.7070	6/39 + 26/47	7/30 + 18/38	0.7381	...	31/42
0.7073	29/41	29/41	0.7390	6/31 + 18/33	12/62 + 36/66
0.7080	30/39 - 3/49	13/58 + 30/62	0.7391	17/23	34/46
0.7083	...	17/24	0.7400	8/39 + 23/43	6/25 + 15/30
0.7090	34/39 - 7/43	31/46 + 2/57	0.7407	20/27	40/54
0.7097	22/31	44/62	0.7410	9/39 + 25/49	49/57 - 7/59
0.7100	20/43 + 12/49	18/24 - 1/25	0.7414	...	43/58
0.7105	...	27/38	0.7419	23/31	46/62
0.7110	22/29 - 1/21	33/39 - 5/37	0.7420	17/39 + 15/49	28/51 + 11/57
0.7119	...	42/59	0.7424	...	49/66
0.7120	6/39 + 24/43	31/54 + 8/58	0.7430	19/39 + 11/43	1/53 + 42/58
0.7121	...	47/66	0.7436	...	29/39
0.7130	27/43 + 4/47	17/30 + 6/41	0.7440	4/29 + 20/33	27/49 + 11/57
0.7140	6/43 + 27/47	45/57 - 4/53	0.7442	32/43	32/43
0.7143	15/21	20/28	0.7447	35/47	35/47
0.7143	35/49	30/42	0.7450	17/21 - 2/31	15/24 + 3/25
0.7143	...	35/49	0.7451	...	38/51
0.7150	28/43 + 3/47	21/25 - 3/24	0.7458	...	44/59
0.7160	2/47 + 33/49	25/51 + 14/62	0.7460	13/47 + 23/49	2/59 + 47/66
0.7170	...	38/53	0.7470	23/41 + 8/43	29/49 + 9/58
0.7170	29/43 + 2/47	28/59 + 16/66	0.7480	19/43 + 15/49	10/53 + 33/59
0.7174	...	33/46	0.7490	13/15 - 2/17	36/47 - 1/59
0.7179	28/39	28/39	0.7500	12/16	18/24
0.7180	22/27 - 3/31	21/58 + 21/59	0.7500	15/20	21/28
0.7190	39/49 - 3/39	12/57 + 30/59	0.7510	11/23 + 9/33	39/53 + 1/66
0.7193	...	41/57	0.7520	19/23 - 2/27	39/57 + 4/59
0.7200	2/43 + 33/49	18/25	0.7530	23/39 + 8/49	11/53 + 36/66
0.7209	31/43	31/43	0.7540	6/37 + 29/49	25/46 + 12/57
0.7210	13/29 + 9/33	21/47 + 17/62	0.7544	...	43/57
0.7220	18/23 - 2/33	13/46 + 29/66	0.7547	...	40/53
0.7222	13/18	39/54	0.7550	24/37 + 5/47	21/24 - 3/25
0.7230	6/29 + 16/31	11/46 + 30/62	0.7551	37/49	37/49

Table 3. (Continued) Accurate Angular Indexing

Part of a Turn	B&S, Becker, Hendeny, K&T, & Rockford	Cincinnati and LeBlond	Part of a Turn	B&S, Becker, Hendeny, K&T, & Rockford	Cincinnati and LeBlond
0.7560	1/47 + 36/49	9/47 + 35/62	0.7860	17/37 + 16/49	49/58 - 3/51
0.7561	31/41	31/41	0.7870	10/39 + 26/49	30/37 - 1/42
0.7568	28/37	28/37	0.7872	37/47	37/47
0.7570	15/43 + 20/49	8/53 + 40/66	0.7879	26/33	52/66
0.7576	25/33	50/66	0.7880	6/39 + 26/41	45/51 - 5/53
0.7580	16/37 + 14/43	48/59 - 3/54	0.7890	19/41 + 14/43	37/49 + 2/59
0.7581	...	47/62	0.7895	...	30/38
0.7586	22/29	44/58	0.7895	...	45/57
0.7590	28/47 + 8/49	36/41 - 5/42	0.7900	15/37 + 15/39	18/24 + 1/25
0.7593	...	41/54	0.7903	...	49/62
0.7600	39/47 - 3/43	19/25	0.7907	34/43	34/43
0.7609	...	35/46	0.7910	8/29 + 17/33	7/49 + 35/54
0.7610	19/43 + 15/47	34/51 + 5/53	0.7917	...	19/24
0.7619	16/21	32/42	0.7920	8/29 + 16/31	4/47 + 41/58
0.7620	38/47 - 2/43	16/51 + 26/58	0.7925	...	42/53
0.7627	...	45/59	0.7930	10/39 + 22/41	7/47 + 38/59
0.7630	14/37 + 15/39	36/46 - 1/51	0.7931	23/29	46/58
0.7632	...	29/38	0.7940	28/43 + 7/49	14/57 + 34/62
0.7640	29/39 + 1/49	27/57 + 18/62	0.7941	...	27/34
0.7647	13/17	26/34	0.7949	31/39	31/39
0.7647	...	39/51	0.7950	24/37 + 6/41	21/24 - 2/25
0.7650	16/27 + 5/29	3/24 + 16/25	0.7959	39/49	39/49
0.7660	36/47	36/47	0.7960	2/39 + 35/47	18/37 + 13/42
0.7660	13/37 + 17/41	4/37 + 25/38	0.7963	...	43/54
0.7667	...	23/30	0.7966	...	47/59
0.7670	14/41 + 20/47	31/38 - 2/41	0.7970	40/47 - 2/37	13/53 + 32/58
0.7674	33/43	33/43	0.7980	14/39 + 18/41	33/51 + 8/53
0.7680	21/41 + 11/43	21/41 + 11/43	0.7990	3/37 + 28/39	10/28 + 19/43
0.7690	16/47 + 21/49	15/54 + 28/57	0.8000	12/15	20/25
0.7692	30/39	30/39	0.8000	16/20	24/30
0.7700	14/23 + 5/31	6/24 + 13/25	0.8010	32/37 - 3/47	10/47 + 30/51
0.7710	21/39 + 10/43	48/59 - 2/47	0.8020	27/31 - 2/29	54/62 - 4/58
0.7719	...	44/57	0.8030	18/39 + 14/41	18/39 + 14/41
0.7720	2/37 + 28/39	2/37 + 28/39	0.8030	...	53/66
0.7727	...	51/66	0.8039	...	41/51
0.7730	20/27 + 1/31	1/34 + 29/39	0.8040	10/43 + 28/49	32/49 + 8/53
0.7736	...	41/53	0.8043	...	37/46
0.7740	32/39 - 2/43	32/39 - 2/43	0.8049	33/41	33/41
0.7742	24/31	48/62	0.8050	22/23 - 5/33	3/24 + 17/25
0.7750	6/16 + 8/20	9/24 + 12/30	0.8060	34/41 - 1/43	13/47 + 27/51
0.7755	38/49	38/49	0.8065	25/31	50/62
0.7759	...	45/58	0.8070	5/15 + 9/19	15/58 + 34/62
0.7760	36/41 - 5/49	5/51 + 40/59	0.8070	...	46/57
0.7770	6/23 + 16/31	47/59 - 1/51	0.8080	19/21 - 3/31	22/39 + 10/41
0.7778	14/18	42/54	0.8085	38/47	38/47
0.7778	21/27	...	0.8090	22/39 + 12/49	28/53 + 16/57
0.7780	16/41 + 19/49	41/47 - 5/53	0.8095	...	34/42
0.7790	6/41 + 31/49	49/57 - 5/62	0.8100	33/43 + 2/47	6/24 + 14/25
0.7797	...	46/59	0.8103	...	47/58
0.7800	28/37 + 1/43	17/25 + 3/30	0.8108	30/37	30/37
0.7805	32/41	32/41	0.8110	7/27 + 16/29	34/53 + 10/59
0.7810	12/23 + 7/27	17/57 + 28/58	0.8113	...	43/53
0.7820	28/31 - 4/33	45/49 - 9/66	0.8120	17/29 + 7/31	34/58 + 14/62
0.7826	18/23	36/46	0.8125	13/16	...
0.7830	13/31 + 12/33	23/46 + 15/53	0.8130	6/43 + 33/49	16/24 + 6/41
0.7838	29/37	29/37	0.8136	...	48/59
0.7840	21/23 - 4/31	34/47 + 4/66	0.8140	35/43	35/43
0.7843	...	40/51	0.8140	28/33 - 1/29	14/47 + 32/62
0.7850	32/43 + 2/49	15/24 + 4/25	0.8148	22/27	44/54
0.7857	...	22/28	0.8150	22/47 + 17/49	9/24 + 11/25
0.7857	...	33/42	0.8158	...	31/38

Table 3. (Continued) Accurate Angular Indexing

Part of a Turn	B&S, Becker, Hendeny, K&T, & Rockford	Cincinnati and LeBlond	Part of a Turn	B&S, Becker, Hendeny, K&T, & Rockford	Cincinnati and LeBlond
0.8160	5/37 + 32/47	23/54 + 6/43	0.8478	...	39/46
0.8163	40/49	40/49	0.8480	30/41 + 5/43	31/59 + 20/62
0.8170	12/17 + 2/18	13/54 + 34/59	0.8485	28/33	56/66
0.8180	30/39 + 2/41	33/54 + 12/58	0.8490	13/41 + 25/47	2/47 + 50/62
0.8182	27/33	54/66	0.8491	...	45/53
0.8190	26/37 + 5/43	20/34 + 9/39	0.8500	17/20	18/24 + 3/30
0.8200	28/39 + 5/49	8/25 + 15/30	0.8510	5/21 + 19/31	22/37 + 10/39
0.8205	32/39	32/39	0.8511	40/47	40/47
0.8210	10/21 + 10/29	10/59 + 43/66	0.8519	23/27	46/54
0.8214	...	23/28	0.8520	1/16 + 15/19	55/62 - 2/57
0.8220	18/41 + 18/47	11/57 + 39/62	0.8529	...	29/34
0.8226	...	51/62	0.8530	17/21 + 1/23	19/58 + 31/59
0.8230	34/39 - 2/41	4/49 + 43/58	0.8537	35/41	35/41
0.8235	14/17	28/34	0.8540	15/39 + 23/49	54/62 - 1/59
0.8235	...	42/51	0.8548	...	53/62
0.8240	15/37 + 18/43	19/53 + 27/58	0.8550	19/37 + 14/41	9/24 + 12/25
0.8246	...	47/57	0.8560	24/43 + 14/47	37/53 + 9/57
0.8250	6/16 + 9/20	7/24 + 16/30	0.8570	3/43 + 37/47	51/57 - 2/53
0.8260	4/31 + 23/33	39/62 + 13/66	0.8571	18/21	24/28
0.8261	19/23	38/46	0.8571	42/49	36/42
0.8270	32/41 + 2/43	46/58 + 2/59	0.8571	...	42/49
0.8276	24/29	48/58	0.8580	25/43 + 13/47	38/51 + 7/62
0.8280	35/41 - 1/39	35/41 - 1/39	0.8590	11/27 + 14/31	22/54 + 28/62
0.8290	5/37 + 34/49	10/34 + 23/43	0.8596	...	49/57
0.8293	34/41	34/41	0.8600	1/43 + 41/49	9/25 + 15/30
0.8298	39/47	39/47	0.8605	37/43	37/43
0.8300	17/23 + 3/33	18/24 + 2/25	0.8610	16/37 + 21/49	18/46 + 31/66
0.8302	...	44/53	0.8620	13/37 + 24/47	17/38 + 17/41
0.8305	...	49/59	0.8621	25/29	50/58
0.8310	34/39 - 2/49	39/49 + 2/57	0.8627	...	44/51
0.8320	27/43 + 10/49	27/53 + 20/62	0.8630	38/41 - 3/47	18/46 + 25/53
0.8330	9/37 + 23/39	42/47 - 4/66	0.8636	...	57/66
0.8333	15/18	20/24	0.8640	11/16 + 3/17	56/62 - 2/51
0.8333	...	25/30	0.8644	...	51/59
0.8333	...	35/42	0.8649	32/37	32/37
0.8333	...	45/54	0.8650	4/41 + 33/43	15/24 + 6/25
0.8333	...	55/66	0.8660	10/17 + 5/18	13/57 + 37/58
0.8340	15/23 + 6/33	20/38 + 12/39	0.8667	13/15	26/30
0.8350	43/49 - 2/47	21/24 - 1/25	0.8670	3/21 + 21/29	28/54 + 23/66
0.8360	2/41 + 37/47	32/46 + 8/57	0.8679	...	46/53
0.8367	41/49	41/49	0.8680	36/47 + 5/49	53/59 - 2/66
0.8370	19/29 + 6/33	33/57 + 16/62	0.8684	...	33/38
0.8372	...	36/43	0.8690	40/43 - 3/49	39/47 + 2/51
0.8378	...	31/37	0.8696	20/23	40/46
0.8380	7/39 + 27/41	20/46 + 25/62	0.8700	4/39 + 33/43	18/24 + 3/25
0.8387	26/31	52/62	0.8704	...	47/54
0.8390	30/39 + 3/43	3/49 + 42/54	0.8710	27/31	54/62
0.8400	19/37 + 16/49	21/25	0.8710	17/27 + 7/29	31/51 + 15/57
0.8410	23/43 + 15/49	44/51 - 1/46	0.8718	34/39	34/39
0.8420	34/37 - 3/39	46/49 - 6/62	0.8720	30/37 + 3/49	26/58 + 25/59
0.8421	16/19	32/38	0.8723	41/47	41/47
0.8421	...	48/57	0.8730	15/39 + 21/43	21/49 + 24/54
0.8430	6/37 + 32/47	9/47 + 43/66	0.8740	15/39 + 23/47	5/53 + 46/59
0.8431	...	43/51	0.8750	14/16	21/24
0.8440	17/21 + 1/29	41/54 + 5/59	0.8760	21/23 - 1/27	48/57 + 2/59
0.8448	...	49/58	0.8770	3/37 + 39/49	37/51 + 10/66
0.8450	29/37 + 3/49	3/24 + 18/25	0.8772	...	50/57
0.8460	27/37 + 5/43	22/54 + 25/57	0.8776	43/49	43/49
0.8462	33/39	33/39	0.8780	24/47 + 18/49	31/53 + 17/58
0.8470	5/23 + 17/27	26/38 + 7/43	0.8780	36/41	36/41
0.8475	...	50/59	0.8788	...	58/66

Table 3. (Continued) Accurate Angular Indexing

Part of a Turn	B&S, Becker, Hendeny, K&T, & Rockford	Cincinnati and LeBlond	Part of a Turn	B&S, Becker, Hendeny, K&T, & Rockford	Cincinnati and LeBlond
0.8790	22/43 + 18/49	52/58 - 1/57	0.9110	31/37 + 3/41	31/37 + 3/41
0.8793	...	51/58	0.9118	...	31/34
0.8800	31/39 + 4/47	22/25	0.9120	26/37 + 9/43	52/43 - 11/37
0.8810	...	37/42	0.9123	...	52/57
0.8810	19/29 + 7/31	8/51 + 42/58	0.9130	2/31 + 28/33	35/62 + 23/66
0.8814	...	52/59	0.9130	21/23	42/46
0.8820	20/37 + 14/41	42/57 + 9/62	0.9138	...	53/58
0.8824	15/17	30/34	0.9140	7/21 + 18/31	42/47 + 1/49
0.8824	...	45/51	0.9149	43/47	43/47
0.8830	27/41 + 11/49	7/51 + 44/59	0.9150	8/17 + 8/18	21/24 + 1/25
0.8837	38/43	38/43	0.9153	...	54/59
0.8840	23/29 + 3/33	37/47 + 6/62	0.9160	35/43 + 5/49	40/53 + 10/62
0.8850	7/23 + 18/31	3/24 + 19/25	0.9167	...	22/24
0.8860	38/41 - 2/49	38/59 + 15/62	0.9170	19/23 + 3/33	29/38 + 6/39
0.8868	...	47/53	0.9180	1/41 + 42/47	39/46 + 4/57
0.8870	28/41 + 10/49	34/51 + 13/59	0.9184	45/49	45/49
0.8871	...	55/62	0.9189	34/37	34/37
0.8880	18/41 + 22/49	28/51 + 20/59	0.9190	14/23 + 9/29	8/46 + 38/51
0.8889	16/18	48/54	0.9194	...	57/62
0.8889	24/27	...	0.9200	28/37 + 8/49	23/25
0.8890	8/41 + 34/49	53/57 - 2/49	0.9210	17/37 + 18/39	23/49 + 28/62
0.8900	39/41 - 3/49	6/24 + 16/25	0.9211	...	35/38
0.8910	29/41 + 9/49	52/57 - 1/47	0.9216	...	47/51
0.8913	...	41/46	0.9220	26/39 + 12/47	10/34 + 27/43
0.8919	33/37	33/37	0.9229	31/37 + 4/47	...
0.8920	19/41 + 21/49	17/47 + 35/66	0.9230	...	29/54 + 22/57
0.8929	...	25/28	0.9231	36/39	36/39
0.8930	27/37 + 8/49	5/46 + 40/51	0.9240	15/41 + 24/43	45/59 + 10/62
0.8936	42/47	42/47	0.9242	...	61/66
0.8939	...	59/66	0.9245	...	49/53
0.8940	27/29 - 1/27	28/49 + 20/62	0.9250	14/16 + 1/20	7/24 + 19/30
0.8947	17/19	34/38	0.9259	25/27	50/54
0.8947	...	51/57	0.9260	17/43 + 26/49	2/51 + 47/53
0.8950	30/41 + 8/49	9/24 + 13/25	0.9268	38/41	38/41
0.8960	20/41 + 20/49	8/47 + 45/62	0.9270	28/37 + 8/47	29/59 + 27/62
0.8966	26/29	52/58	0.9280	3/39 + 40/47	47/57 + 6/58
0.8970	14/43 + 28/49	7/57 + 48/62	0.9286	...	26/28
0.8974	35/39	35/39	0.9286	...	39/42
0.8980	44/49	44/49	0.9290	12/37 + 26/43	16/53 + 37/59
0.8980	1/39 + 41/47	28/57 + 24/59	0.9298	...	53/57
0.8983	...	53/59	0.9300	5/29 + 25/33	6/24 + 17/25
0.8990	8/39 + 34/49	42/51 + 4/53	0.9302	40/43	40/43
0.9000	18/20	27/30	0.9310	25/37 + 12/47	7/30 + 30/43
0.9010	28/29 - 2/31	27/58 + 27/62	0.9310	27/29	54/58
0.9020	20/27 + 5/31	46/51	0.9320	30/39 + 7/43	59/62 + 1/51
0.9020	...	29/53 + 22/62	0.9322	...	55/59
0.9024	37/41	37/41	0.9330	34/39 + 3/49	5/42 + 35/43
0.9030	17/41 + 21/43	17/41 + 21/43	0.9333	14/15	28/30
0.9032	28/31	56/62	0.9340	1/37 + 39/43	56/59 - 1/66
0.9040	17/41 + 23/47	7/53 + 44/57	0.9348	...	43/46
0.9048	19/21	38/42	0.9350	2/39 + 38/43	9/24 + 14/25
0.9050	38/43 + 1/47	15/24 + 7/25	0.9355	29/31	58/62
0.9057	...	48/53	0.9360	15/37 + 26/49	13/58 + 42/59
0.9060	17/43 + 24/47	17/58 + 38/62	0.9362	44/47	44/47
0.9070	39/43	39/43	0.9370	19/21 + 1/31	29/53 + 23/59
0.9070	14/29 + 14/33	7/47 + 47/62	0.9375	15/16	...
0.9074	...	49/54	0.9380	13/39 + 26/43	21/46 + 26/54
0.9080	1/27 + 27/31	29/54 + 23/62	0.9388	46/49	46/49
0.9090	14/37 + 26/49	8/53 + 47/62	0.9390	30/37 + 5/39	30/37 + 5/39
0.9091	30/33	60/66	0.9394	31/33	62/66
0.9100	14/39 + 27/49	18/24 + 4/25	0.9400	35/39 + 2/47	16/25 + 9/30

Table 3. (Continued) Accurate Angular Indexing

Part of a Turn	B&S, Becker, HendeY, K&T, & Rockford	Cincinnati and LeBlond	Part of a Turn	B&S, Becker, HendeY, K&T, & Rockford	Cincinnati and LeBlond
0.9410	30/41 + 9/43	25/47 + 27/66	0.9670	9/47 + 38/49	8/34 + 30/41
0.9412	16/17	32/34	0.9677	30/31	60/62
0.9412	...	48/51	0.9680	26/37 + 13/49	2/46 + 49/53
0.9420	15/37 + 22/41	42/47 + 3/62	0.9690	26/39 + 13/43	5/51 + 54/62
0.9430	9/23 + 16/29	12/49 + 37/53	0.9697	32/33	64/66
0.9434	...	50/53	0.9700	12/23 + 13/29	6/24 + 18/25
0.9440	9/43 + 36/49	26/46 + 25/66	0.9706	...	33/34
0.9444	17/18	51/54	0.9710	26/37 + 11/41	14/46 + 34/51
0.9450	37/41 + 2/47	15/24 + 8/25	0.9720	26/43 + 18/49	31/53 + 24/62
0.9459	35/37	35/37	0.9730	36/37	36/37
0.9460	12/39 + 30/47	22/46 + 29/62	0.9730	20/23 + 3/29	26/54 + 29/59
0.9470	33/47 + 12/49	14/49 + 41/62	0.9737	...	37/38
0.9474	18/19	36/38	0.9740	16/21 + 7/33	26/34 + 9/43
0.9474	...	54/57	0.9744	38/39	38/39
0.9480	18/37 + 18/39	11/38 + 27/41	0.9750	10/16 + 7/20	13/24 + 13/30
0.9483	...	55/58	0.9756	40/41	40/41
0.9487	37/39	37/39	0.9760	14/39 + 29/47	10/49 + 44/57
0.9490	1/15 + 15/17	13/47 + 39/58	0.9762	...	41/42
0.9492	...	56/59	0.9767	42/43	42/43
0.9500	19/20	6/24 + 21/30	0.9770	33/37 + 4/47	30/47 + 21/62
0.9510	29/43 + 13/47	41/53 + 11/62	0.9780	25/37 + 13/43	25/37 + 13/43
0.9512	39/41	39/41	0.9783	...	45/46
0.9516	...	59/62	0.9787	46/47	46/47
0.9520	8/43 + 36/47	30/53 + 22/57	0.9790	13/23 + 12/29	10/53 + 49/62
0.9524	20/21	40/42	0.9796	48/49	48/49
0.9530	5/43 + 41/49	16/59 + 45/66	0.9800	23/39 + 16/41	17/25 + 9/30
0.9535	41/43	41/43	0.9804	...	50/51
0.9540	29/37 + 8/47	28/54 + 27/62	0.9810	22/43 + 23/49	51/58 + 6/59
0.9545	...	63/66	0.9811	...	52/53
0.9550	7/39 + 38/49	21/24 + 2/25	0.9815	...	53/54
0.9560	13/37 + 26/43	13/37 + 26/43	0.9820	30/39 + 10/47	19/46 + 33/58
0.9565	22/23	44/46	0.9825	...	56/57
0.9570	14/21 + 9/31	21/47 + 25/49	0.9828	...	57/58
0.9574	45/47	45/47	0.9830	26/41 + 15/43	45/57 + 12/62
0.9580	5/39 + 39/47	20/53 + 36/62	0.9831	...	58/59
0.9583	...	23/24	0.9839	...	61/62
0.9590	21/41 + 21/47	18/51 + 40/66	0.9840	13/37 + 31/49	1/46 + 51/53
0.9592	47/49	47/49	0.9848	...	65/66
0.9600	7/39 + 32/41	24/25	0.9850	6/23 + 21/29	15/24 + 9/25
0.9608	...	49/51	0.9860	16/23 + 9/31	42/53 + 12/62
0.9610	11/23 + 14/29	5/34 + 35/43	0.9870	15/21 + 9/33	13/34 + 26/43
0.9620	28/41 + 12/43	52/59 + 5/62	0.9880	7/39 + 38/47	5/46 + 51/58
0.9623	...	51/53	0.9890	33/39 + 7/49	20/39 + 20/42
0.9630	26/27	52/54	0.9900	10/29 + 20/31	18/24 + 6/25
0.9630	30/43 + 13/49	1/51 + 50/53	0.9910	22/23 + 1/29	21/46 + 31/58
0.9640	21/39 + 20/47	52/57 + 3/58	0.9920	39/41 + 2/49	40/53 + 14/59
0.9643	...	27/28	0.9930	8/23 + 20/31	21/53 + 37/62
0.9649	...	55/57	0.9940	7/23 + 20/29	14/46 + 40/58
0.9650	11/39 + 28/41	3/24 + 21/25	0.9950	35/39 + 4/41	21/24 + 3/25
0.9655	28/29	56/58	0.9960	40/41 + 1/49	43/46 + 3/49
0.9660	13/39 + 31/49	15/39 + 25/43	0.9970	15/23 + 10/29	30/46 + 20/58
0.9661	...	57/59	0.9980	20/41 + 25/49	12/51 + 45/59
0.9667	...	29/30	0.9990	10/41 + 37/49	6/51 + 52/59

Approximate Indexing for Small Angles.—To find *approximate* indexing movements for small angles, such as the remainder from the method discussed in *Angular Indexing* starting on page 1991, on a dividing head with a 40:1 worm-gear ratio, divide 540 by the number of minutes in the angle, and then divide the number of holes in each of the available indexing circles by this quotient. The result that is closest to a whole number is the best approximation of the angle for a simple indexing movement and is the number of holes to be moved in the corresponding circle of holes. If the angle is greater than 9 degrees, the

whole number will be greater than the number of holes in the circle, indicating that one or more full turns of the crank are required. Dividing by the number of holes in the indicated circle of holes will reduce the required indexing movement to the number of full turns, and the remainder will be the number of holes to be moved for the fractional turn. If the angle is less than about 11 minutes, it cannot be indexed by simple indexing with standard B & S plates (the corresponding angle for standard plates on a Cincinnati head is about 8 minutes, and for Cincinnati high number plates, 2.7 minutes. See Tables 5, 6a, and 6b for indexing movements with Cincinnati standard and high number plates).

Example: An angle of $7^{\circ} 25'$ is to be indexed. Expressed in minutes, it is $445'$ and 540 divided by 445 equals 1.213483 . The indexing circles available on standard B & S plates are 15, 16, 17, 18, 19, 20, 21, 23, 27, 29, 31, 33, 37, 39, 41, 43, 47, and 49. Each of these numbers is divided by 1.213483 and the closest to a whole number is found to be $17 \div 1.213483 = 14.00926$. The best approximation for a simple indexing movement to obtain $7^{\circ} 25'$ is 14 holes on the 17-hole circle.

Differential Indexing.—This method is the same, in principle, as compound indexing (see *Compound Indexing* on page 1985), but differs from the latter in that the index plate is rotated by suitable gearing that connects it to the spiral-head spindle. This rotation or differential motion of the index plate takes place when the crank is turned, the plate moving either in the same direction as the crank or opposite to it, as may be required. The result is that the *actual* movement of the crank, at every indexing, is either greater or less than its movement with relation to the index plate. The differential method makes it possible to obtain almost any division by using only one circle of holes for that division and turning the index crank in one direction, as with plain indexing.

The gears to use for turning the index plate the required amount (when gears are required) are shown by Tables 4a and 4b, *Simple and Differential Indexing with Browne & Sharpe Indexing Plates*, which shows what divisions can be obtained by plain indexing, and when it is necessary to use gears and the differential system. For example, if 50 divisions are required, the 20-hole index circle is used and the crank is moved 16 holes, but no gears are required. For 51 divisions, a 24-tooth gear is placed on the wormshaft and a 48-tooth gear on the spindle. These two gears are connected by two idler gears having 24 and 44 teeth, respectively.

To illustrate the principle of differential indexing, suppose a dividing head is to be geared for 271 divisions. Table 4b calls for a gear on the wormshaft having 56 teeth, a spindle gear with 72 teeth, and a 24-tooth idler to rotate the index plate in the same direction as the crank. The sector arms should be set to give the crank a movement of 3 holes in the 21-hole circle. If the spindle and the index plate were not connected through gearing, 280 divisions would be obtained by successively moving the crank 3 holes in the 21-hole circle, but the gears cause the index plate to turn in the same direction as the crank at such a rate that, when 271 indexings have been made, the work is turned one complete revolution. Therefore, we have 271 divisions instead of 280, the number being reduced because the total movement of the crank, for each indexing, is equal to the movement relative to the index plate, *plus* the movement of the plate itself when, as here, the crank and plate rotate in the same direction.

If they were rotated in opposite directions, the crank would have a total movement equal to the amount it turned relative to the plate, *minus* the plate's movement. Sometimes it is necessary to use compound gearing to move the index plate the required amount for each turn of the crank. The differential method cannot be used in connection with helical or spiral milling because the spiral head is then geared to the leadscrew of the machine.

Finding Ratio of Gearing for Differential Indexing.—To find the ratio of gearing for differential indexing, first select some approximate number A of divisions either greater or less than the required number N . For example, if the required number N is 67, the approximate number A might be 70. Then, if 40 turns of the index crank are required for 1 revolu-

tion of the spindle, the gearing ratio $R = (A - N) \times 40/A$. If the approximate number A is less than N , the formula is the same as above except that $A - N$ is replaced by $N - A$.

Example: Find the gearing ratio and indexing movement for 67 divisions.

$$\text{If } A = 70, \text{ gearing ratio} = (70 - 67) \times \frac{40}{70} = \frac{12}{7} = \frac{\text{gear on spindle (driver)}}{\text{gear on worm (driven)}}$$

The fraction $12/7$ is raised to obtain a numerator and a denominator to match gears that are available. For example, $12/7 = 48/28$.

Various combinations of gearing and index circles are possible for a given number of divisions. The index numbers and gear combinations in the accompanying Tables 4a and 4b apply to a given series of index circles and gear-tooth numbers. The approximate number A on which any combination is based may be determined by dividing 40 by the fraction representing the indexing movement. For example, the approximate number used for 109 divisions equals $40 \div 6/16$, or $40 \times 16/6 = 106\frac{2}{3}$. If this approximate number is inserted in the preceding formula, it will be found that the gear ratio is $7/8$, as shown in the table.

Second Method of Determining Gear Ratio: In illustrating a somewhat different method of obtaining the gear ratio, 67 divisions will again be used. If 70 is selected as the approximate number, then $40/70 = 4/7$ or $12/21$ turn of the index crank will be required. If the crank is indexed four-sevenths of a turn, sixty-seven times, it will make $4/7 \times 67 = 38\frac{2}{7}$ revolutions. This number is $1\frac{5}{7}$ turns less than the 40 required for one revolution of the work (indicating that the gearing should be arranged to rotate the index plate in the same direction as the index crank to increase the indexing movement). Hence the gear ratio $1\frac{5}{7} = 12/7$.

To Find the Indexing Movement.—The indexing movement is represented by the fraction $40/A$. For example, if 70 is the approximate number A used in calculating the gear ratio for 67 divisions, then, to find the required movement of the index crank, reduce $40/70$ to any fraction of equal value and having as denominator any number equal to the number of holes available in an index circle.

$$\text{To illustrate, } \frac{40}{70} = \frac{4}{7} = \frac{12}{21} = \frac{\text{number of holes indexed}}{\text{number of holes in index circle}}$$

Use of Idler Gears.—In differential indexing, idler gears are used to rotate the index plate in the same direction as the index crank, thus *increasing* the resulting indexing movement, or to rotate the index plate in the opposite direction, thus *reducing* the resulting indexing movement.

Example 1: If the approximate number A is *greater* than the required number of divisions N , simple gearing will require one idler, and compound gearing, no idler. Index plate and crank rotate in the same direction.

Example 2: If the approximate number A is *less* than the required number of divisions N , simple gearing requires two idlers, and compound gearing, one idler. Index plate and crank rotate in opposite directions.

When Compound Gearing Is Required.—It is sometimes necessary, as shown in the table, to use a train of four gears to obtain the required ratio with the gear-tooth numbers that are available.

Example: Find the gear combination and indexing movement for 99 divisions, assuming that an approximate number A of 100 is used.

$$\text{Ratio} = (100 - 99) \times \frac{40}{100} = \frac{4}{10} = \frac{4 \times 1}{5 \times 2} = \frac{32}{40} \times \frac{28}{56}$$

The final numbers here represent available gear sizes. The gears having 32 and 28 teeth are the drivers (gear on spindle and first gear on stud), and gears having 40 and 56 teeth are

driven (second gear on stud and gear on wormshaft). The indexing movement is represented by the fraction $\frac{40}{100}$, which is reduced to $\frac{8}{20}$, the 20-hole index circle being used here.

Example: Determine the gear combination to use for indexing 53 divisions. If 56 is used as an approximate number (possibly after one or more trial solutions to find an approximate number and resulting gear ratio coinciding with available gears):

$$\text{Gearing ratio} = (56 - 53) \times \frac{40}{56} = \frac{15}{7} = \frac{3 \times 5}{1 \times 7} = \frac{72 \times 40}{24 \times 56}$$

The tooth numbers above the line here represent *gear on spindle* and *first gear on stud*. The tooth numbers below the line represent *second gear on stud* and *gear on wormshaft*.

$$\text{Indexing movement} = \frac{40}{56} = \frac{5}{7} = \frac{5 \times 7}{7 \times 7} = \frac{35 \text{ holes}}{49\text{-hole circle}}$$

To Check the Number of Divisions Obtained with a Given Gear Ratio and Index Movement.—Invert the fraction representing the indexing movement. Let C = this inverted fraction and R = gearing ratio.

Example 1: If simple gearing with one idler, or compound gearing with no idler, is used: number of divisions $N = 40C - RC$.

For instance, if the gear ratio is $\frac{12}{7}$, there is simple gearing and one idler, and the indexing movement is $\frac{12}{21}$, making the inverted fraction C , $\frac{21}{12}$; find the number of divisions N .

$$N = \left(40 \times \frac{21}{12}\right) - \left(\frac{12}{7} \times \frac{21}{12}\right) = 70 - \frac{21}{7} = 67$$

Example 2: If simple gearing with two idlers, or compound gearing with one idler, is used: number of divisions $N = 40C + RC$.

For instance, if the gear ratio is $\frac{7}{8}$, two idlers are used with simple gearing, and the indexing movement is 6 holes in the 16-hole circle, then number of divisions:

$$N = \left(40 \times \frac{16}{6}\right) + \left(\frac{7}{8} \times \frac{16}{6}\right) = 109$$

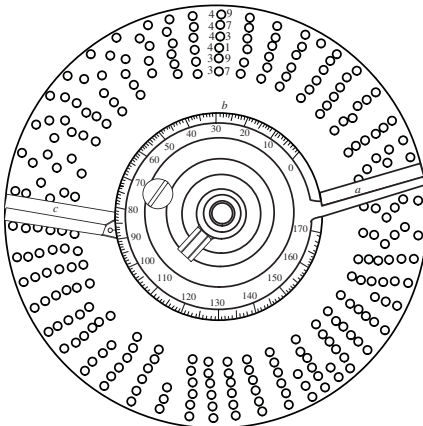

Sector Graduations

Table 4a. Simple and Differential Indexing with Browne & Sharpe Indexing Plates

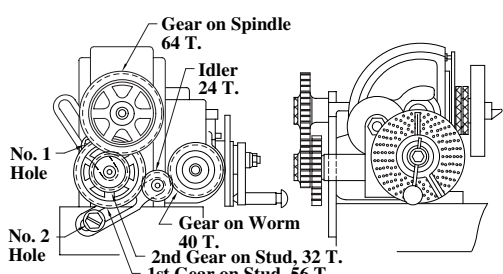
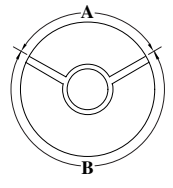
Geared for 107 Divisions

No. of Div.	Index Circle	No. of Turns of Crank	Graduation on Sector	No. of Div.	Index Circle	No. of Turns of Crank	Graduation on Sector	Gear on Worm	No. 1 Hole		Gear on Spindle	Idlers	
									First Gear on Stud	Second Gear on Stud		No. 1 Hole	No. 2 Hole
2	Any	20	...	33	33	17/33	41						
3	39	13 13/39	65	34	17	13/17	33						
4	Any	10	...	35	49	17/49	26						
5	Any	8	...	36	27	13/27	21						
6	39	6 2/39	132	37	37	13/37	15						
7	49	5 3/49	140	38	19	17/19	9						
8	Any	5	...	39	39	13/39	3						
9	27	4 2/27	88	40	Any	1	...						
10	Any	4	...	41	41	40/41	3*						
11	33	3 2/33	126	42	21	20/21	9*						
12	39	3 1/39	65	43	43	40/43	12*						
13	39	3 2/39	14	44	33	30/33	17*						
14	49	2 4/49	169	45	27	24/27	21*						
15	39	2 2/39	132	46	23	20/23	172						
16	20	2 1/20	98	47	47	40/47	168						
17	17	2 9/17	69	48	18	15/18	165						
18	27	2 2/27	43	49	49	40/49	161						
19	19	2 2/19	19	50	20	16/20	158						
20	Any	2	...	51	17	14/17	33*	24	48	24	44
21	21	1 19/21	18*	52	39	30/39	152
22	33	1 2/33	161	53	49	35/49	140	56	40	24	72
23	23	1 17/23	147	54	27	20/27	147
24	39	1 2/39	132	55	33	24/33	144
25	20	1 1/20	118	56	49	35/49	140
26	39	1 2/39	106	57	21	15/21	142	56	40	24	44
27	27	1 1/27	95	58	29	20/29	136
28	49	1 2/49	83	59	39	26/39	132	48	32	44	...
29	29	1 1/29	75	60	39	26/39	132
30	39	1 1/39	65	61	39	26/39	132	48	32	24	44
31	31	1 3/31	56	62	31	20/31	127
32	20	1 1/20	48	63	39	26/39	132	24	48	24	44

Note: The data in columns labeled Graduation on Sector refer to a graduated dial that accompanies the sector arms on some dividing heads, page 2011. The graduated sector ring eliminates the requirement of counting holes and thereby lessens the possibility of error. Graduations in table indicate setting for sector arms when index crank moves through arc A, except figures marked *, when crank moves through arc B.

Differential Indexing
Certain divisions such as 51, 53, 57, etc., require the use of differential indexing. In differential indexing, change gears are used to transmit motion from the main spindle of the dividing head to the index plate, which turns (either in the same direction as the index plate or in the opposite direction) whatever amount is required to obtain the correct indexing movement.

The numbers in the columns below represent numbers of teeth for the change gears necessary to give the divisions required. Where no numbers are shown simple indexing, which does not require change gears, is used.

Differential Gears					
24	48	24	44
...
56	40	24	72
...
...
56	40	24	44
...
48	32	44	...
...
48	32	24	44
...
24	48	24	44

**Table 4b. Simple and Differential Indexing
Browne & Sharpe Indexing Plates**

No. of Divisions	Index Circle	No. of Turns of Crank	Graduation on Sector ^a	Gear on Worm	No. 1 Hole		Gear on Spindle	Idlers	
					First Gear on Stud	Second Gear on Stud		No. 1 Hole	No. 2 Hole ^b
64	16	10/16	123
65	39	24/39	121
66	33	20/33	120
67	21	12/21	113	28	48	44	...
68	17	10/17	116
69	20	12/20	118	40	56	24	44
70	49	28/49	112
71	18	10/18	109	72	40	24	...
72	27	15/27	110
73	21	12/21	113	28	48	24	44
74	37	20/37	107
75	15	8/15	105
76	19	10/19	103
77	20	10/20	98	32	48	44	...
78	39	20/39	101
79	20	10/20	98	48	24	44	...
80	20	10/20	98
81	20	10/20	98	48	24	24	44
82	41	20/41	96
83	20	10/20	98	32	48	24	44
84	21	10/21	94
85	17	8/17	92
86	43	20/48	91
87	15	7/15	92	40	24	24	44
88	33	15/33	89
89	18	8/18	87	72	32	44	...
90	27	12/27	88
91	39	18/39	91	24	48	24	44
92	23	10/23	86
93	18	8/18	87	24	32	24	44
94	47	20/47	83
95	19	8/19	82
96	21	9/21	85	28	32	24	44
97	20	8/20	78	40	48	44	...
98	49	20/49	79
99	20	8/20	78	56	28	40	32
100	20	8/20	78
101	20	8/20	78	72	24	40	48	...	24
102	20	8/20	78	40	32	24	44
103	20	8/20	78	40	48	24	44
104	39	15/39	75
105	21	8/21	75
106	43	16/43	73	86	24	24	48
107	20	8/20	78	40	56	32	64	...	24
108	27	10/27	73
109	16	6/16	73	32	28	24	44
110	33	12/33	71
111	39	13/39	65	24	72	32	...
112	39	13/39	65	24	64	44	...
113	39	13/39	65	24	56	44	...
114	39	13/39	65	24	48	44	...
115	23	8/23	68
116	29	10/29	68
117	39	13/39	65	24	24	56	...
118	39	13/39	65	48	32	44	...
119	39	13/39	65	72	24	44	...
120	39	13/39	65
121	39	13/39	65	72	24	24	44
122	39	13/39	65	48	32	24	44
123	39	13/39	65	24	24	24	44
124	31	10/31	63

**Table 4b. (Continued) Simple and Differential Indexing
Browne & Sharpe Indexing Plates**

No. of Divisions	Index Circle	No. of Turns of Crank	Graduation on Sector ^a	Gear on Worm	No. 1 Hole		Gear on Spindle	Idlers	
					First Gear on Stud	Second Gear on Stud		No. 1 Hole	No. 2 Hole ^b
125	39	13/39	65	24	40	24	44
126	39	13/39	65	24	48	24	44
127	39	13/39	65	24	56	24	44
128	16	5/16	61
129	39	13/39	65	24	72	24	44
130	39	12/39	60
131	20	6/20	58	40	28	44	...
132	33	10/33	59
133	21	6/21	56	24	48	44	...
134	21	6/21	56	28	48	44	...
135	27	8/27	58
136	17	5/17	57
137	21	6/21	56	28	24	56	...
138	21	6/21	56	56	32	44	...
139	21	6/21	56	56	32	48	24
140	49	14/49	55
141	18	5/18	54	48	40	44	...
142	21	6/21	56	56	32	24	44
143	21	6/21	56	28	24	24	44
144	18	5/18	54
145	29	8/29	54
146	21	6/21	56	28	48	24	44
147	21	6/21	56	24	48	24	44
148	37	10/37	53
149	21	6/21	56	28	72	24	44
150	15	4/15	52
151	20	5/20	48	32	72	44	...
152	19	5/19	51
153	20	5/20	48	32	56	44	...
154	20	5/20	48	32	48	44	...
155	31	8/31	50
156	39	10/39	50
157	20	5/20	48	32	24	56	...
158	20	5/20	48	48	24	44	...
159	20	5/20	48	64	32	56	28
160	20	5/20	48
161	20	5/20	48	64	32	56	28	...	24
162	20	5/20	48	48	24	24	44
163	20	5/20	48	32	24	24	44
164	41	10/41	47
165	33	8/33	47
166	20	5/20	48	32	48	24	44
167	20	5/20	48	32	56	24	44
168	21	5/21	47
169	20	5/20	48	32	72	24	44
170	17	4/17	45
171	21	5/21	47	56	40	24	44
172	43	10/43	44
173	18	4/18	43	72	56	32	64
174	18	4/18	43	24	32	56	...
175	18	4/18	43	72	40	32	64
176	18	4/18	43	72	24	24	64
177	18	4/18	43	72	48	24	...
178	18	4/18	43	72	32	44	...
179	18	4/18	43	72	24	48	32
180	18	4/18	43
181	18	4/18	43	72	24	48	32	...	24
182	18	4/18	43	72	32	24	44
183	18	4/18	43	48	32	24	44
184	23	5/23	42
185	37	8/37	42

**Table 4b. (Continued) Simple and Differential Indexing
Browne & Sharpe Indexing Plates**

No. of Divisions	Index Circle	No. of Turns of Crank	Graduation on Sector ^a	Gear on Worm	No. 1 Hole		Gear on Spindle	Idlers	
					First Gear on Stud	Second Gear on Stud		No. 1 Hole	No. 2 Hole ^b
186	18	4/18	43	48	64	24	44
187	18	4/18	43	72	48	24	56	...	24
188	47	10/47	40
189	18	4/18	43	32	64	24	44
190	19	4/19	40
191	20	4/20	38	40	72	24	...
192	20	4/20	38	40	64	44	...
193	20	4/20	38	40	56	44	...
194	20	4/20	38	40	48	44	...
195	39	8/39	39
196	49	10/49	38
197	20	4/20	38	40	24	56	...
198	20	4/20	38	56	28	40	32
199	20	4/20	38	100	40	64	32
200	20	4/20	38
201	20	4/20	38	72	24	40	24	...	24
202	20	4/20	38	72	24	40	48	...	24
203	20	4/20	38	40	24	24	44
204	20	4/20	38	40	32	24	44
204	20	4/20	38	40	32	24	44
205	41	8/41	37
206	20	4/20	38	40	48	24	44
207	20	4/20	38	40	56	24	44
208	20	4/20	38	40	64	24	44
209	20	4/20	38	40	72	24	44
210	21	4/21	37
211	16	3/16	36	64	28	44	...
212	43	8/43	35	86	24	24	48
213	27	5/27	36	72	40	44	...
214	20	4/20	38	40	56	32	64	...	24
215	43	8/43	35
216	27	5/27	36
217	21	4/21	37	48	64	24	44
218	16	3/16	36	64	56	24	44
219	21	4/21	37	28	48	24	44
220	33	6/33	35
221	17	3/17	33	24	24	56	...
222	18	3/18	32	24	72	44	...
223	43	8/43	35	86	8	24	64	...	24
224	18	3/18	32	24	64	44	...
225	27	5/27	36	24	40	24	44
226	18	3/18	32	24	56	44	...
227	49	8/49	30	56	64	28	72
228	18	3/18	32	24	48	44	...
229	18	3/18	32	24	44	48	...
230	23	4/23	34
231	18	3/18	32	32	48	44	...
232	29	5/29	33
233	18	3/18	32	48	56	44	...
234	18	3/18	32	24	24	56	...
235	47	8/47	32
236	18	3/18	32	48	32	44	...
237	18	3/18	32	48	24	44	...
238	18	3/18	32	72	24	44	...
239	18	3/18	32	72	24	64	32
240	18	3/18	32
241	18	3/18	32	72	24	64	32	...	24
242	18	3/18	32	72	24	24	44
243	18	3/18	32	64	32	24	44
244	18	3/18	32	48	32	24	44
245	49	8/49	30

**Table 4b. (Continued) Simple and Differential Indexing
Browne & Sharpe Indexing Plates**

No. of Divisions	Index Circle	No. of Turns of Crank	Graduation on Sector ^a	Gear on Worm	No. 1 Hole		Gear on Spindle	Idlers	
					First Gear on Stud	Second Gear on Stud		No. 1 Hole	No. 2 Hole ^b
246	18	3/18	32	24	24	24	44
247	18	3/18	32	48	56	24	44
248	31	5/31	31
249	18	3/18	32	32	48	24	44
250	18	3/18	32	24	40	24	44
251	18	3/18	32	48	44	32	64	...	24
252	18	3/18	32	24	48	24	44
253	33	5/33	29	24	40	56	...
254	18	3/18	32	24	56	24	44
255	18	3/18	32	48	40	24	72	...	24
256	18	3/18	32	24	64	24	44
257	49	8/49	30	56	48	28	64	...	24
258	43	7/43	31	32	64	24	44
259	21	3/21	28	24	72	44	...
260	39	6/39	29
261	29	4/29	26	48	64	24	72
262	20	3/20	28	40	28	44	...
263	49	8/49	30	56	64	28	72	...	24
264	33	5/33	29
265	21	3/21	28	56	40	24	72
266	21	3/21	28	32	64	44	...
267	27	4/27	28	72	32	44	...
268	21	3/21	28	28	48	44	...
269	20	3/20	28	64	32	40	28	...	24
270	27	4/27	28
271	21	3/21	28	56	24	24	72
272	21	3/21	28	56	64	24	...
273	21	3/21	28	24	24	56	...
274	21	3/21	28	56	48	44	...
275	21	3/21	28	56	40	44	...
276	21	3/21	28	56	32	44	...
277	21	3/21	28	56	24	44	...
278	21	3/21	28	56	32	48	24
279	27	4/27	28	24	32	24	44
280	49	7/49	26
281	21	3/21	28	72	24	56	24	...	24
282	43	6/43	26	86	24	24	56
283	21	3/21	28	56	24	24	44
284	21	3/21	28	56	32	24	44
285	21	3/21	28	56	40	24	44
286	21	3/21	28	56	48	24	44
287	21	3/21	28	24	24	24	44
288	21	3/21	28	28	32	24	44
289	21	3/21	28	56	24	24	72	...	24
290	29	4/29	26
291	15	2/15	25	40	48	44	...
292	21	3/21	28	28	48	24	44
293	15	2/15	25	48	32	40	56
294	21	3/21	28	24	48	24	44
295	15	2/15	25	48	32	44	...
296	37	5/37	26
297	33	4/33	23	28	48	24	56
298	21	3/21	28	28	72	24	44
299	23	3/23	25	24	24	56	...
300	15	2/15	25
301	43	6/43	26	24	48	24	44
302	16	2/16	24	32	72	24	...
303	15	2/15	25	72	24	40	48	...	24
304	16	2/16	24	24	48	44	...
305	15	2/15	25	48	32	24	44
306	15	2/15	25	40	32	24	44

**Table 4b. (Continued) Simple and Differential Indexing
Browne & Sharpe Indexing Plates**

No. of Divisions	Index Circle	No. of Turns of Crank	Graduation on Sector ^a	Gear on Worm	No. 1 Hole		Gear on Spindle	Idlers	
					First Gear on Stud	Second Gear on Stud		No. 1 Hole	No. 2 Hole ^b
307	15	2/15	25	72	48	40	56	...	24
308	16	2/16	24	32	48	44	...
309	15	2/15	25	40	48	24	44
310	31	4/31	24
311	16	2/16	24	64	24	24	72
312	39	5/39	24
313	16	2/16	24	32	28	56	...
314	16	2/16	24	32	24	56	...
315	16	2/16	24	64	40	24	...
316	16	2/16	24	64	32	44	...
317	16	2/16	24	64	24	44	...
318	16	2/16	24	56	28	48	24
319	29	4/29	26	48	64	24	72	...	24
320	16	2/16	24
321	16	2/16	24	72	24	64	24	...	24
322	23	3/23	25	32	64	24	44
323	16	2/16	24	64	24	24	44
324	16	2/16	24	64	32	24	44
325	16	2/16	24	64	40	24	44
326	16	2/16	24	32	24	24	44
327	16	2/16	24	32	28	24	44
328	41	5/41	23
329	16	2/16	24	64	24	24	72	...	24
330	33	4/33	23
331	16	2/16	24	64	44	24	48	...	24
332	16	2/16	24	32	48	24	44
333	18	2/18	21	24	72	44	...
334	16	2/16	24	32	56	24	44
335	33	4/33	23	72	48	44	40	...	24
336	16	2/16	24	32	64	24	44
337	43	5/43	21	86	40	32	56
338	16	2/16	24	32	72	24	44
339	18	2/18	21	24	56	44	...
340	17	2/17	22
341	43	5/43	21	86	24	32	40
342	18	2/18	21	32	64	44	...
343	15	2/15	25	40	64	24	86	...	24
344	43	5/43	21
345	18	2/18	21	24	40	56	...
346	18	2/18	21	72	56	32	64
347	43	5/43	21	86	24	32	40	...	24
348	18	2/18	21	24	32	56	...
349	18	2/18	21	72	44	24	48
350	18	2/18	21	72	40	32	64
351	18	2/18	21	24	24	56	...
352	18	2/18	21	72	24	24	64
353	18	2/18	21	72	24	24	56
354	18	2/18	21	72	48	24	...
355	18	2/18	21	72	40	24	...
356	18	2/18	21	72	32	24	...
357	18	2/18	21	72	24	44	...
358	18	2/18	21	72	32	48	24
359	43	5/43	21	86	48	32	100	...	24
360	18	2/18	21
361	19	2/19	19	32	64	44	...
362	18	2/18	21	72	28	56	32	...	24
363	18	2/18	21	72	24	24	44
364	18	2/18	21	72	32	24	44

^a See Note on page 2012.^b On B & S numbers 1, 1½, and 2 machines, number 2 hole is in the machine table. On numbers 3 and 4 machines, number 2 hole is in the head.

Table 5. Indexing Movements for Standard Index Plate Cincinnati Milling Machine

The standard index plate indexes all numbers up to and including 60; all even numbers and those divisible by 5 up to 120; and all divisions listed below up to 400. This plate is drilled on both sides, and has holes as follows: First side: 24, 25, 28, 30, 34, 37, 38, 39, 41, 42, 43. Second side: 46, 47, 49, 51, 53, 54, 57, 58, 59, 62, 66.												
No. of Divisions	Index Plate Circle	No. of Turns	No. of Holes	No. of Divisions	Index Plate Circle	No. of Holes	No. of Divisions	Index Plate Circle	No. of Holes	No. of Divisions	Index Plate Circle	No. of Holes
2	Any	20	...	44	66	60	104	39	15	205	41	8
3	24	13	8	45	54	48	105	42	16	210	42	8
4	Any	10	...	46	46	40	106	53	20	212	53	10
5	Any	8	...	47	47	40	108	54	20	215	43	8
6	24	6	16	48	24	20	110	66	24	216	54	10
7	28	5	20	49	49	40	112	28	10	220	66	12
8	Any	5	...	50	25	20	114	57	20	224	28	5
9	54	4	24	51	51	40	115	46	16	228	57	10
10	Any	4	...	52	39	30	116	58	20	230	46	8
11	66	3	42	53	53	40	118	59	20	232	58	10
12	24	3	8	54	54	40	120	66	22	235	47	8
13	39	3	3	55	66	48	124	62	20	236	59	10
14	49	2	42	56	28	20	125	25	8	240	66	11
15	24	2	16	57	57	40	130	39	12	245	49	8
16	24	2	12	58	58	40	132	66	20	248	62	10
17	34	2	12	59	59	40	135	54	16	250	25	4
18	54	2	12	60	42	28	136	34	10	255	51	8
19	38	2	4	62	62	40	140	28	8	260	39	6
20	Any	2	...	64	24	15	144	54	15	264	66	10
21	42	1	38	65	39	24	145	58	16	270	54	8
22	66	1	54	66	66	40	148	37	10	272	34	5
23	46	1	34	68	34	20	150	30	8	280	28	4
24	24	1	16	70	28	16	152	38	10	290	58	8
25	25	1	15	72	54	30	155	62	16	296	37	5
26	39	1	21	74	37	20	156	39	10	300	30	4
27	54	1	26	75	30	16	160	28	7	304	38	5
28	42	1	18	76	38	20	164	41	10	310	62	8
29	58	1	22	78	39	20	165	66	16	312	39	5
30	24	1	8	80	34	17	168	42	10	320	24	3
31	62	1	18	82	41	20	170	34	8	328	41	5
32	28	1	7	84	42	20	172	43	10	330	66	8
33	66	1	14	85	34	16	176	66	15	336	42	5
34	34	1	6	86	43	20	180	54	12	340	34	4
35	28	1	4	88	66	30	184	46	10	344	43	5
36	54	1	6	90	54	24	185	37	8	360	54	6
37	37	1	3	92	46	20	188	47	10	368	46	5
38	38	1	2	94	47	20	190	38	8	370	37	4
39	39	1	1	95	38	16	192	24	5	376	47	5
40	Any	1	...	96	24	10	195	39	8	380	38	4
41	41	...	40	98	49	20	196	49	10	390	39	4
42	42	...	40	100	25	10	200	30	6	392	49	5
43	43	...	40	102	51	20	204	51	10	400	30	3

**Table 6a. Indexing Movements for High Numbers
Cincinnati Milling Machine**

This set of 3 index plates indexes all numbers up to and including 200; all even numbers and those divisible by 5 up to and including 400. The plates are drilled on each side, making six sides *A, B, C, D, E* and *F*.

Example:—It is required to index 35 divisions. The preferred side is *F*, since this requires the least number of holes; but should one of plates *D, A* or *E* be in place, either can be used, thus avoiding the changing of plates.

No. of Divisions	Side	Circle	Turns	Holes	No. of Divisions	Side	Circle	Turns	Holes	No. of Divisions	Side	Circle	Turns	Holes
2	Any	Any	20	15	<i>C</i>	93	2	62	28	<i>D</i>	77	1	33
3	<i>A</i>	30	13	10	15	<i>F</i>	159	2	106	28	<i>A</i>	91	1	39
3	<i>B</i>	36	13	12	16	<i>E</i>	26	2	13	29	<i>E</i>	87	1	33
3	<i>E</i>	42	13	14	16	<i>F</i>	28	2	14	30	<i>A</i>	30	1	10
3	<i>C</i>	93	13	31	16	<i>A</i>	30	2	15	30	<i>B</i>	36	1	12
3	<i>F</i>	159	13	53	16	<i>D</i>	32	2	16	30	<i>E</i>	42	1	14
4	Any	Any	10	16	<i>C</i>	34	2	17	30	<i>C</i>	93	1	31
5	Any	Any	8	16	<i>B</i>	36	2	18	30	<i>F</i>	159	1	53
6	<i>A</i>	30	6	20	17	<i>C</i>	34	2	12	31	<i>C</i>	93	1	27
6	<i>B</i>	36	6	24	17	<i>E</i>	119	2	42	32	<i>F</i>	28	1	7
6	<i>E</i>	42	6	28	17	<i>C</i>	153	2	54	32	<i>D</i>	32	1	8
6	<i>C</i>	93	6	62	17	<i>F</i>	187	2	66	32	<i>B</i>	36	1	9
6	<i>F</i>	159	6	106	18	<i>B</i>	36	2	8	32	<i>A</i>	48	1	12
7	<i>F</i>	28	5	20	18	<i>A</i>	99	2	22	33	<i>A</i>	99	1	21
7	<i>E</i>	42	5	30	18	<i>C</i>	153	2	34	34	<i>C</i>	34	1	6
7	<i>D</i>	77	5	55	19	<i>F</i>	38	2	4	34	<i>E</i>	119	1	21
7	<i>A</i>	91	5	65	19	<i>E</i>	133	2	14	34	<i>F</i>	187	1	33
8	Any	Any	5	19	<i>A</i>	171	2	18	35	<i>F</i>	28	1	4
9	<i>B</i>	36	4	16	20	Any	Any	2	35	<i>D</i>	77	1	11
9	<i>A</i>	99	4	44	21	<i>E</i>	42	1	38	35	<i>A</i>	91	1	13
9	<i>C</i>	153	4	68	21	<i>A</i>	147	1	133	35	<i>E</i>	119	1	17
10	Any	Any	4	22	<i>D</i>	44	1	36	36	<i>B</i>	36	1	4
11	<i>D</i>	44	3	28	22	<i>A</i>	99	1	81	36	<i>A</i>	99	1	11
11	<i>A</i>	99	3	63	22	<i>F</i>	143	1	117	36	<i>C</i>	153	1	17
11	<i>F</i>	143	3	91	23	<i>C</i>	46	1	34	37	<i>B</i>	111	1	9
12	<i>A</i>	30	3	10	23	<i>A</i>	69	1	51	38	<i>F</i>	38	1	2
12	<i>B</i>	36	3	12	23	<i>E</i>	161	1	119	38	<i>E</i>	133	1	7
12	<i>E</i>	42	3	14	24	<i>A</i>	30	1	20	38	<i>A</i>	171	1	9
12	<i>C</i>	93	3	31	24	<i>B</i>	36	1	24	39	<i>A</i>	117	1	3
12	<i>F</i>	159	3	53	24	<i>E</i>	42	1	28	40	Any	Any	1
13	<i>E</i>	26	3	2	24	<i>C</i>	93	1	62	41	<i>C</i>	123	120
13	<i>A</i>	91	3	7	24	<i>F</i>	159	1	106	42	<i>E</i>	42	40
13	<i>F</i>	143	3	11	25	<i>A</i>	30	1	18	42	<i>A</i>	147	140
13	<i>B</i>	169	3	13	25	<i>E</i>	175	1	105	43	<i>A</i>	129	120
14	<i>F</i>	28	2	24	26	<i>F</i>	26	1	14	44	<i>D</i>	44	40
14	<i>E</i>	42	2	36	26	<i>A</i>	91	1	49	44	<i>A</i>	99	90
14	<i>D</i>	77	2	66	26	<i>B</i>	169	1	91	44	<i>F</i>	143	130
14	<i>A</i>	91	2	78	27	<i>B</i>	81	1	39	45	<i>B</i>	36	32
15	<i>A</i>	30	2	20	27	<i>A</i>	189	1	91	45	<i>A</i>	99	88
15	<i>B</i>	36	2	24	28	<i>F</i>	28	1	12	45	<i>C</i>	153	136
15	<i>E</i>	42	2	28	28	<i>E</i>	42	1	18	46	<i>C</i>	46	40

**Table 6b. Indexing Movements for High Numbers
Cincinnati Milling Machine**

No. of Division	Side	Circle	Holes	No. of Divisions	Side	Circle	Holes	No. of Division	Side	Circle	Holes
46	A	69	60	70	E	119	68	96	B	36	15
46	E	161	140	71	F	71	40	96	A	48	20
47	B	141	120	72	B	36	20	97	B	97	40
48	A	30	25	72	A	117	65	98	A	147	60
48	B	36	30	72	C	153	85	99	A	99	40
49	A	147	120	73	E	73	40	100	A	30	12
50	A	30	24	74	B	111	60	100	E	175	70
50	E	175	140	75	A	30	16	101	F	101	40
51	C	153	120	76	F	38	20	102	C	153	60
52	E	26	20	76	E	133	70	103	E	103	40
52	A	91	70	76	A	171	90	104	E	26	10
52	F	143	110	77	D	77	40	104	A	91	35
52	B	169	130	78	A	117	60	104	F	143	55
53	F	159	120	79	C	79	40	104	B	169	65
54	B	81	60	80	E	26	13	105	E	42	16
54	A	189	140	80	F	28	14	105	A	147	56
55	D	44	32	80	A	30	15	106	F	159	60
55	F	143	104	80	D	32	16	107	D	107	40
56	F	28	20	80	C	34	17	108	B	81	30
56	E	42	30	80	B	36	18	108	A	189	70
56	D	77	55	80	E	42	21	109	C	109	40
56	A	91	65	81	B	81	40	110	D	44	16
57	A	171	120	82	C	123	60	110	A	99	36
58	E	87	60	83	F	83	40	110	F	143	52
59	A	177	120	84	E	42	20	111	B	111	40
60	A	30	20	84	A	147	70	112	F	28	10
60	B	36	24	85	C	34	16	112	E	42	15
60	E	42	28	85	E	119	56	113	F	113	40
60	F	159	106	85	F	187	88	114	A	171	60
61	B	183	120	86	A	129	60	115	C	46	16
62	C	93	60	87	E	87	40	115	A	69	24
63	A	189	120	88	D	44	20	115	E	161	56
64	D	32	20	88	A	99	45	116	E	87	30
64	A	48	30	88	F	143	65	117	A	117	40
65	E	26	16	89	D	89	40	118	A	177	60
65	A	91	56	90	B	36	16	119	E	119	40
65	F	143	88	90	A	99	44	120	A	30	10
65	B	169	104	90	C	153	68	120	B	36	12
66	A	99	60	91	A	91	40	120	E	42	14
67	B	67	40	92	C	46	20	120	C	93	31
68	C	34	20	92	A	69	30	120	F	159	53
68	E	119	70	92	E	161	70	121	D	121	40
68	F	187	110	93	C	93	40	122	B	183	60
69	A	69	40	94	B	141	60	123	C	123	40
70	F	28	16	95	F	38	16	124	C	93	30
70	D	42	24	95	E	133	56	125	E	175	56
70	A	91	52	95	A	171	72	126	A	189	60
127	B	127	40	160	A	48	12	198	A	99	20
128	D	32	10	161	E	161	40	199	B	199	40
128	A	48	15	162	B	81	20	200	A	30	6
129	A	129	40	163	D	163	40	200	E	175	35
130	E	26	8	164	C	123	30	202	F	101	20
130	A	91	28	165	A	99	24	204	C	153	30
130	F	143	44	166	F	83	20	205	C	123	24
130	B	169	52	167	C	167	40	206	E	103	20
131	F	131	40	168	E	42	10	208	E	26	5
132	A	99	30	168	A	147	35	210	E	42	8
133	E	133	40	169	B	169	40	210	A	147	28
134	B	67	20	170	C	34	8	212	F	159	30
135	B	81	24	170	E	119	28	214	D	107	20
135	A	189	56	170	F	187	44	215	A	129	24
136	C	34	10	171	A	171	40	216	B	81	15
136	E	119	35	172	A	129	30	216	A	189	35

**Table 6b. (Continued) Indexing Movements for High Numbers
Cincinnati Milling Machine**

No. of Division	Side	Circle	Holes	No. of Divisions	Side	Circle	Holes	No. of Division	Side	Circle	Holes
137	D	137	40	173	F	173	40	218	C	109	20
138	A	69	20	174	E	87	20	220	D	44	8
139	C	139	40	175	E	175	40	220	A	99	18
140	F	28	8	176	D	44	10	220	F	143	26
140	E	42	12	177	A	177	40	222	B	111	20
140	D	77	22	178	D	89	20	224	F	28	5
140	A	91	26	179	D	179	40	226	F	113	20
141	B	141	40	180	B	36	8	228	A	171	30
142	F	71	20	180	A	99	22	230	C	46	8
143	F	143	40	180	C	153	34	230	A	69	12
144	B	36	10	181	C	181	40	230	E	161	28
145	E	87	24	182	A	91	20	232	E	87	15
146	E	73	20	183	B	183	40	234	A	117	20
147	A	147	40	184	C	46	10	235	B	141	24
148	B	111	30	184	A	69	15	236	A	177	30
149	E	149	40	184	E	161	35	238	E	119	20
150	A	30	8	185	B	111	24	240	A	30	5
151	D	151	40	186	C	93	20	240	B	36	6
152	F	38	10	187	F	187	40	240	E	42	7
152	E	133	35	188	B	141	30	240	A	48	8
152	A	171	45	189	A	189	40	242	D	121	20
153	C	153	40	190	F	38	8	244	B	183	30
154	D	77	20	190	E	133	28	245	A	147	24
155	C	93	24	190	A	171	36	246	C	123	20
156	A	117	30	191	E	191	40	248	C	93	15
157	B	157	40	192	A	48	10	250	E	175	28
158	C	79	20	193	D	193	40	252	A	189	30
159	F	159	40	194	B	97	20	254	B	127	20
160	F	28	7	195	A	117	24	255	C	153	24
160	D	32	8	196	A	147	30	256	D	32	5
160	B	36	9	197	C	197	40	258	A	129	20
260	E	26	4	304	F	38	5	354	A	177	20
260	A	91	14	305	B	183	24	355	F	71	8
260	F	143	22	306	C	153	20	356	D	89	10
260	B	169	26	308	D	77	10	358	D	179	20
262	F	131	20	310	C	93	12	360	B	36	4
264	A	99	15	312	A	117	15	360	A	99	11
265	F	159	24	314	B	157	20	360	C	153	17
266	E	133	20	315	A	189	24	362	C	181	20
268	B	67	10	316	C	79	10	364	A	91	10
270	B	81	12	318	F	159	20	365	E	73	8
270	A	189	28	320	D	32	4	366	B	183	20
272	C	34	5	320	A	48	6	368	C	46	5
274	D	137	20	322	E	161	20	370	B	111	12
276	A	69	10	324	B	81	10	372	C	93	10
278	C	139	20	326	D	163	20	374	F	187	20
280	F	28	4	328	C	123	15	376	B	141	15
280	E	42	6	330	A	99	12	378	A	189	20
280	D	77	11	332	F	83	10	380	F	38	4
280	A	91	13	334	C	167	20	380	E	133	14
282	B	141	20	335	B	67	8	380	A	171	18
284	F	71	10	336	E	42	5	382	E	191	20
285	A	171	24	338	B	169	20	384	A	48	5
286	F	143	20	340	C	34	4	385	D	77	8
288	B	36	5	340	E	119	14	386	D	193	20
290	E	87	12	340	F	187	22	388	B	97	10
292	E	73	10	342	A	171	20	390	A	117	12
294	A	147	20	344	A	129	15	392	A	147	15
295	A	177	24	345	A	69	8	394	C	197	20
296	B	111	15	346	F	173	20	395	C	79	8
298	E	149	20	348	E	87	10	396	A	99	10
300	A	30	4	350	E	175	20	398	B	199	20
302	D	151	20	352	D	44	5	400	A	30	3

Indexing Tables.—Indexing tables are usually circular, with a flat, T-slotted table, 12 to 24 in. in diameter, to which workpieces can be clamped. The flat table surface may be horizontal, universal, or angularly adjustable. The table can be turned continuously through 360° about an axis normal to the surface. Rotation is through a worm drive with a graduated scale, and a means of angular readout is provided. Indexed locations to 0.25° with accuracy of ± 0.1 second can be obtained from mechanical means, or greater accuracy from an autocollimator or sine-angle attachment built into the base, or under numerical control. Provision is made for locking the table at any angular position while a machining operation is being performed.

Power for rotation of the table during machining can be transmitted, as with a dividing head, for cutting a continuous, spiral scroll, for instance. The indexing table is usually more rigid and can be used with larger workpieces than the dividing head.

Block or Multiple Indexing for Gear Cutting.—With the block system of indexing, numbers of teeth are indexed at one time, instead of cutting the teeth consecutively, and the gear is revolved several times before all the teeth are finished. For example, when cutting a gear having 25 teeth, the indexing mechanism is geared to index four teeth at once (see Table 7) and the first time around, six widely separated tooth spaces are cut. The second time around, the cutter is one tooth behind the spaces originally milled. On the third indexing, the cutter has dropped back another tooth, and the gear in question is thus finished by indexing it through four cycles.

The various combinations of change gears to use for block or multiple indexing are given in the accompanying Table 7. The advantage claimed for block indexing is that the heat generated by the cutter (especially when cutting cast iron gears of coarse pitch) is distributed more evenly about the rim and is dissipated to a greater extent, thus avoiding distortion due to local heating and permitting higher speeds and feeds to be used.

Table 7 gives values for use with Brown & Sharpe automatic gear cutting machines, but the gears for any other machine equipped with a similar indexing mechanism can be calculated easily. Assume, for example, that a gear cutter requires the following change gears for indexing a certain number of teeth: driving gears having 20 and 30 teeth, respectively, and driven gears having 50 and 60 teeth.

Then if it is desired to cut, for instance, every fifth tooth, multiply the fractions $20/60$ and $30/50$ by 5. Then $20/60 \times 30/50 \times 5/1 = 1/1$. In this instance, the blank could be divided so that every fifth space was cut, by using gears of equal size. The number of teeth in the gear and the number of teeth indexed in each block must not have a common factor.

Table 7. Block or Multiple Indexing for Gear Cutting

Number of Teeth to be Cut	Number Indexed at Once	1st Driver	1st Follower	2nd Driver	2nd Follower	Turns of Locking Disk	Number of Teeth to be Cut	Number Indexed at Once	1st Driver	1st Follower	2nd Driver	2nd Follower	Turns of Locking Disk
25	4	100	50	72	30	4	36	5	100	48	80	40	4
26	3	100	50	90	52	4	37	5	100	30	90	74	4
27	2	100	50	60	54	4	38	5	100	30	90	76	4
28	3	100	50	90	56	4	39	5	100	30	90	78	4
29	3	100	50	90	58	4	40	3	100	50	90	80	4
30	7	100	30	84	40	4	41	5	100	30	90	82	4
31	3	100	50	90	62	4	42	5	100	30	90	84	4
32	3	100	50	90	64	4	43	5	100	30	90	86	4
33	4	100	50	80	44	4	44	5	100	30	90	88	4
34	3	100	50	90	68	4	45	7	100	50	70	30	4
35	4	100	50	96	56	4	46	5	100	30	90	92	4

Table 7. (Continued) Block or Multiple Indexing for Gear Cutting

Number of Teeth to be Cut	Number Indexed at Once	1st Driver	1st Follower	2nd Driver	2nd Follower	Turns of Locking Disk	Number of Teeth to be Cut	Number Indexed at Once	1st Driver	1st Follower	2nd Driver	2nd Follower	Turns of Locking Disk
47	5	100	30	90	94	4	119	3	100	70	72	68	2
48	5	100	30	90	96	4	120	7	100	50	70	40	2
49	5	100	30	90	98	4	121	4	60	66	96	44	2
50	7	100	50	84	40	4	123	7	100	30	84	82	2
51	4	100	30	96	68	2	124	5	100	60	90	62	2
52	5	100	30	90	52	2	125	7	100	50	84	50	2
54	5	100	30	90	54	2	126	5	100	50	50	42	2
55	4	100	50	96	44	2	128	5	100	60	90	64	2
56	5	100	30	90	56	2	129	7	100	30	84	86	2
57	4	100	30	96	76	2	130	7	100	50	84	52	2
58	5	100	30	90	58	2	132	5	100	88	80	40	2
60	7	100	30	84	40	2	133	4	100	70	96	76	2
62	5	100	30	90	62	2	134	5	100	60	90	67	2
63	5	100	30	80	56	2	135	7	100	50	84	54	2
64	5	100	30	90	64	2	136	5	100	60	90	68	2
65	4	100	50	96	52	2	138	5	100	92	80	40	2
66	5	100	44	80	40	2	140	3	50	50	90	70	2
67	5	100	30	90	67	2	141	5	100	94	80	40	2
68	5	100	30	90	68	2	143	6	90	66	96	52	2
69	5	100	46	80	40	2	144	5	100	60	90	72	2
70	3	100	50	90	70	2	145	6	100	50	72	58	2
72	5	100	30	90	72	2	147	5	100	98	80	40	2
74	5	100	30	90	74	2	148	5	100	60	90	74	2
75	7	100	30	84	50	2	150	7	100	60	84	50	2
76	5	100	30	90	76	2	152	5	100	60	90	76	2
77	4	100	70	96	44	2	153	5	100	68	80	60	2
78	5	100	30	90	78	2	154	5	100	56	72	66	2
80	3	100	50	90	80	2	155	6	100	50	72	62	2
81	7	100	30	84	52	2	156	5	100	60	90	78	2
82	5	100	30	90	82	2	160	7	100	50	84	64	2
84	5	100	30	90	84	2	161	5	100	70	60	46	2
85	4	100	50	96	68	2	162	7	100	60	84	52	2
86	5	100	30	90	86	2	164	5	100	60	90	82	2
87	7	100	30	84	58	2	165	7	100	50	84	66	2
88	5	100	30	90	88	2	168	5	100	60	90	84	2
90	7	100	30	70	50	2	169	6	96	52	90	78	2
91	3	100	70	72	52	2	170	7	100	50	84	68	2
92	5	100	30	90	92	2	171	5	70	42	80	76	2
93	7	100	30	84	62	2	172	5	100	60	90	86	2
94	5	100	30	90	94	2	174	7	100	60	84	58	2
95	4	100	50	96	76	2	175	8	100	50	96	70	2
96	5	100	30	90	96	2	176	5	100	60	90	88	2
98	5	100	30	90	98	2	180	7	100	60	70	50	2
99	10	100	30	80	44	2	182	9	90	56	96	52	2
100	7	100	50	84	40	2	184	5	100	60	90	92	2
102	5	100	30	60	68	2	185	6	100	50	72	74	2
104	5	100	60	90	52	2	186	7	100	60	84	62	2
105	4	100	70	96	60	2	187	5	100	44	48	68	2
108	7	100	30	70	60	2	188	5	100	60	90	94	2
110	7	100	50	84	44	2	189	5	100	60	80	84	2
111	5	100	74	80	40	2	190	7	100	50	84	76	2
112	5	100	60	90	56	2	192	5	100	60	90	96	2
114	7	100	30	84	76	2	195	7	100	50	84	78	2
115	8	100	50	96	46	2	196	5	100	60	90	98	2
116	5	100	60	90	58	2	198	7	100	50	70	66	2
117	8	100	30	96	78	2	200	7	60	60	84	40	2

Table 8. Indexing Movements for 60-Tooth Worm-Wheel Dividing Head

Divisions	Index Circle	No. of Turns	No. of Holes	Divisions	Index Circle	No. of Turns	No. of Holes	Divisions	Index Circle	No. of Holes	Divisions	Index Circle	No. of Holes
2	Any	30	..	50	60	1	12	98	49	30	146	73	30
3	Any	20	..	51	17	1	3	99	33	20	147	49	20
4	Any	15	..	52	26	1	4	100	60	36	148	37	15
5	Any	12	..	53	53	1	7	101	101	60	149	149	60
6	Any	10	..	54	27	1	3	102	17	10	150	60	24
7	21	8	12	55	33	1	3	103	103	60	151	151	60
8	26	7	13	56	28	1	2	104	26	15	152	76	30
9	21	6	14	57	19	1	1	105	21	12	153	51	20
10	Any	6	..	58	29	1	1	106	53	30	154	77	30
11	33	5	15	59	59	1	1	107	107	60	155	31	12
12	Any	5	..	60	Any	1	..	108	27	15	156	26	10
13	26	4	16	61	61	..	60	109	109	60	157	157	60
14	21	4	6	62	31	..	30	110	33	18	158	79	30
15	Any	4	..	63	21	..	20	111	37	20	159	53	20
16	28	3	21	64	32	..	30	112	28	15	160	32	12
17	17	3	9	65	26	..	24	113	113	60	161	161	60
18	21	3	7	66	33	..	30	114	19	10	162	27	10
19	19	3	3	67	67	..	60	115	23	12	163	163	60
20	Any	3	..	68	17	..	15	116	29	15	164	41	15
21	21	2	18	69	23	..	20	117	39	20	165	33	12
22	33	2	24	70	21	..	18	118	59	30	166	83	30
23	23	2	14	71	71	..	60	119	119	60	167	167	60
24	26	2	13	72	60	..	50	120	26	13	168	28	10
25	60	2	24	73	73	..	60	121	121	60	169	169	60
26	26	2	8	74	37	..	30	122	61	30	170	17	6
27	27	2	6	75	60	..	48	123	41	20	171	57	20
28	21	2	3	76	19	..	15	124	31	15	172	43	15
29	29	2	2	77	77	..	60	125	100	48	173	173	60
30	Any	2	..	78	26	..	20	126	21	10	174	29	10
31	31	1	29	79	79	..	60	127	127	60	175	35	12
32	32	1	28	80	28	..	21	128	32	15	176	44	15
33	33	1	27	81	27	..	20	129	43	20	177	59	20
34	17	1	13	82	41	..	30	130	26	12	178	89	30
35	21	1	15	83	83	..	60	131	131	60	179	179	60
36	21	1	14	84	21	..	15	132	33	15	180	21	7
37	37	1	23	85	17	..	12	133	133	60	181	181	60
38	19	1	11	86	43	..	30	134	67	30	182	91	30
39	26	1	14	87	29	..	20	135	27	12	183	61	20
40	26	1	13	88	44	..	30	136	68	30	184	46	15
41	41	1	19	89	89	..	60	137	137	60	185	37	12
42	21	1	9	90	21	..	14	138	23	10	186	31	10
43	43	1	17	91	91	..	60	139	139	60	187	187	60
44	33	1	12	92	23	..	15	140	21	9	188	47	15
45	21	1	7	93	31	..	20	141	47	20	189	63	20
46	23	1	7	94	47	..	30	142	71	30	190	19	6
47	47	1	13	95	19	..	12	143	143	60	191	191	60
48	28	1	7	96	32	..	20	144	60	25	192	32	10
49	49	1	11	97	97	..	60	145	29	12	193	193	60

Linear Indexing for Rack Cutting.—When racks are cut on a milling machine, two general methods of linear indexing are used. One is by using the graduated dial on the feed-screw and the other is by using an indexing attachment. The accompanying Table 9 shows the indexing movements when the first method is employed. This table applies to milling machines having feed-screws with the usual lead of $\frac{1}{4}$ inch and 250 dial graduations each equivalent to 0.001 inch of table movement.

$$\text{Actual rotation of feed-screw} = \frac{\text{Linear pitch of rack}}{\text{Lead of feed-screw}}$$

Multiply *decimal* part of turn (obtained by above formula) by 250, to obtain dial reading for fractional part of indexing movement, assuming that dial has 250 graduations.

Table 9. Linear Indexing Movements for Cutting Rack Teeth on a Milling Machine

Pitch of Rack Teeth		Indexing, Movement		Pitch of Rack Teeth		Indexing, Movement	
Diametral Pitch	Linear or Circular	No. of Whole Turns	No. of 0.001 Inch Divisions	Diametral Pitch	Linear or Circular	No. of Whole Turns	No. of 0.001 Inch Divisions
2	1.5708	6	70.8	12	0.2618	1	11.8
2 $\frac{1}{4}$	1.3963	5	146.3	13	0.2417	0	241.7
2 $\frac{1}{2}$	1.2566	5	6.6	14	0.2244	0	224.4
2 $\frac{3}{4}$	1.1424	4	142.4	15	0.2094	0	208.4
3	1.0472	4	47.2	16	0.1963	0	196.3
3 $\frac{1}{2}$	0.8976	3	147.6	17	0.1848	0	184.8
4	0.7854	3	35.4	18	0.1745	0	174.8
5	0.6283	2	128.3	19	0.1653	0	165.3
6	0.5263	2	23.6	20	0.1571	0	157.1
7	0.4488	1	198.8	22	0.1428	0	142.8
8	0.3927	1	142.7	24	0.1309	0	130.9
9	0.3491	1	99.1	26	0.1208	0	120.8
10	0.3142	1	64.2	28	0.1122	0	112.2
11	0.2856	1	35.6	30	0.1047	0	104.7

These movements are for table feed-screws having the usual lead of $\frac{1}{4}$ inch

Note: The linear pitch of the rack equals the circular pitch of gear or pinion which is to mesh with the rack. The table gives both standard diametral pitches and their equivalent linear or circular pitches.

Example: Find indexing movement for cutting rack to mesh with a pinion of 10 diametral pitch.

Indexing movement equals 1 whole turn of feed-screw plus 64.2 thousandths or divisions on feed-screw dial. The feed-screw may be turned this fractional amount by setting dial back to its zero position for each indexing (without backward movement of feed-screw), or, if preferred, 64.2 (in this example) may be added to each successive dial position as shown below.

Dial reading for second position = $64.2 \times 2 = 128.4$ (complete movement = 1 turn \times 64.2 additional divisions by turning feed-screw until dial reading is 128.4).

Third dial position = $64.2 \times 3 = 192.6$ (complete movement = 1 turn + 64.2 additional divisions by turning until dial reading is 192.6).

Fourth position = $64.2 \times 4 - 250 = 6.8$ (1 turn + 64.2 additional divisions by turning feed-screw until dial reading is 6.8 divisions past the zero mark); or, to simplify operation, set dial back to zero for fourth indexing (without moving feed-screw) and then repeat settings for the three previous indexings or whatever number can be made before making a complete turn of the dial.

Counter Milling.—Changing the direction of a linear milling operation by a specific angle requires a linear offset before changing the angle of cut. This compensates for the radius of the milling cutters, as illustrated in Figs. 1a and 1b.

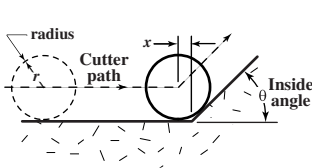

Fig. 1a. Inside Milling

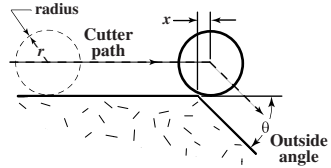

Fig. 1b. Outside Milling

For inside cuts the offset is subtracted from the point at which the cutting direction changes (Fig. 1a), and for outside cuts the offset is added to the point at which the cutting direction changes (Fig. 1b). The formula for the offset is

$$x = rM$$

where x = offset distance; r = radius of the milling cutter; and, M = the multiplication factor ($M = \tan \frac{\theta}{2}$). The value of M for certain angles can be found in Table 10.

Table 10. Offset Multiplication Factors

Deg°	M	Deg°	M	Deg°	M	Deg°	M	Deg°	M
1°	0.00873	19°	0.16734	37°	0.33460	55°	0.52057	73°	0.73996
2°	0.01746	20°	0.17633	38°	0.34433	56°	0.53171	74°	0.75355
3°	0.02619	21°	0.18534	39°	0.35412	57°	0.54296	75°	0.76733
4°	0.03492	22°	0.19438	40°	0.36397	58°	0.55431	76°	0.78129
5°	0.04366	23°	0.20345	41°	0.37388	59°	0.56577	77°	0.79544
6°	0.05241	24°	0.21256	42°	0.38386	60°	0.57735	78°	0.80978
7°	0.06116	25°	0.22169	43°	0.39391	61°	0.58905	79°	0.82434
8°	0.06993	26°	0.23087	44°	0.40403	62°	0.60086	80°	0.83910
9°	0.07870	27°	0.24008	45°	0.41421	63°	0.61280	81°	0.85408
10°	0.08749	28°	0.24933	46°	0.42447	64°	0.62487	82°	0.86929
11°	0.09629	29°	0.25862	47°	0.43481	65°	0.63707	83°	0.88473
12°	0.10510	30°	0.26795	48°	0.44523	66°	0.64941	84°	0.90040
13°	0.11394	31°	0.27732	49°	0.45573	67°	0.66189	85°	0.91633
14°	0.12278	32°	0.28675	50°	0.46631	68°	0.67451	86°	0.93252
15°	0.13165	33°	0.29621	51°	0.47698	69°	0.68728	87°	0.94896
16°	0.14054	34°	0.30573	52°	0.48773	70°	0.70021	88°	0.96569
17°	0.14945	35°	0.31530	53°	0.49858	71°	0.71329	89°	0.98270
18°	0.15838	36°	0.32492	54°	0.50953	72°	0.72654	90°	1.00000

Multiply factor M by the tool radius r to determine the offset dimension