

Trimmer and Brushcutter Safety Manual

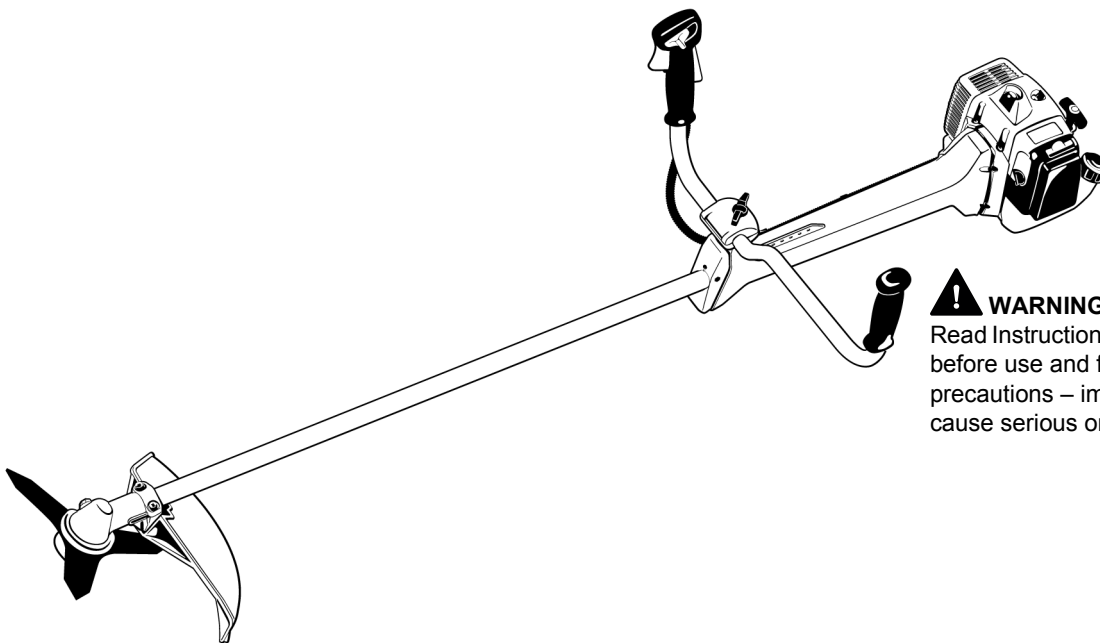

! WARNING
Read Instruction Manual thoroughly
before use and follow all safety
precautions – improper use can
cause serious or fatal injury.



Contents

| | |
|---|----|
| Safety Precautions and Working Techniques | 2 |
| Maintenance and Care | 16 |
| Main Parts | 18 |

This manual contains the safety precautions and recommended working techniques outlined in STIHL instruction manuals for gasoline-powered trimmers/brushcutters. Even if you are an experienced user, it is in your own interest to familiarize yourself with the latest instructions and safety precautions regarding your trimmer/brushcutter.

Please note that the illustrations in the chapter “Main Parts of the Machine” in this manual show the trimmer/brushcutter STIHL FS 130.

Other trimmer/brushcutter models may have different parts and controls. You should therefore always refer to the instruction manual of your particular trimmer/brushcutter.

Contact your STIHL dealer or the STIHL distributor for your area if you do not understand any of the instructions in this manual.



This instruction manual is protected by copyright. All rights reserved, especially the rights to reproduce, translate and process with electronic systems.

Safety Precautions and Working Techniques



Because a trimmer / brushcutter is a high-speed, fast-cutting power tool sometimes equipped with sharp cutting blades, special safety precautions must be observed to reduce the risk of personal injury.



It is important that you read, fully understand and observe the following safety precautions and warnings. Read the instruction manual and the safety precautions periodically. Careless or improper use may cause serious or fatal injury.

The terminology utilized in this manual when referring to the power tool reflects the fact that different types of cutting attachments may be mounted on it. The term "trimmer" is used to designate an FS unit that is equipped with a nylon line head or a head with flexible plastic blades (i.e., the PolyCut head). A "brushcutter" designates a unit equipped with a rigid metal blade. Many FS models may be used as either a trimmer or a brushcutter – therefore, the power tool is referred in this manual as a "trimmer / brushcutter." Some smaller and / or lightweight FS models may only be used as a trimmer, i.e., they may not be used with metal blades.

The term "clearing saw" indicates a high-powered trimmer / brushcutter that is particularly suited for use with a circular saw blade to clear saplings or small trees.

FS models with an "R" on the nameplate were originally configured (at the time of distribution) as a trimmer with a loop handle.



WARNING

As more fully explained later in these Safety Precautions, to reduce the risk of personal injury, make sure your unit is equipped with the proper handle, harness and deflector for the type of cutting attachment you are using. Use only cutting attachments that are specifically authorized by STIHL for use on your FS model.

Have your STIHL dealer show you how to operate your power tool. Observe all applicable local safety regulations, standards and ordinances.



WARNING

Do not lend or rent your power tool without the instruction manual. Be sure that anyone using it understands the information contained in this manual.



WARNING

The use of this machine may be hazardous. If the rotating line or blade comes in contact with your body, it will cut you. When it comes in contact with solid foreign objects such as rocks or bits of metal, it may fling them directly or by ricochet in the direction of bystanders or the operator. Striking such objects could damage the cutting attachment

and may cause blades to crack, chip or break. Thrown objects, including broken heads or blades, may result in serious or fatal injury to the operator or bystanders. STIHL does not recommend the use of rigid blades when cutting in stony areas.

Use your trimmer / brushcutter equipped with the appropriate cutting attachment only for cutting grass, brush, wood and similar material.



WARNING

Do not use it for other purposes, since misuse may result in personal injury or property damage, including damage to the machine.



WARNING

Minors should never be allowed to use this power tool. Bystanders, especially children, and animals should not be allowed in the area where it is in use.



WARNING

To reduce the risk of injury to bystanders and damage to property, never let your power tool run unattended. When it is not in use (e.g. during a work break), shut it off and make sure that unauthorized persons do not use it.

Most of these safety precautions and warnings apply to the use of all STIHL trimmers / brushcutters. Different models may have different parts and controls. See the appropriate section of your instruction manual for a description of the controls and the function of the parts of your model.

Safe use of a trimmer / brushcutter involves

1. the operator
2. the power tool
3. the use of the power tool.

THE OPERATOR

Physical Condition

You must be in good physical condition and mental health and not under the influence of any substance (drugs, alcohol, etc.) which might impair vision, dexterity or judgment. Do not operate this machine when you are fatigued.

WARNING

Be alert – if you get tired, take a break. Tiredness may result in loss of control. Working with any power tool can be strenuous. If you have any condition that might be aggravated by strenuous work, check with your doctor before operating this machine.

WARNING

Prolonged use of a power tool (or other machines) exposing the operator to vibrations may produce whitefinger disease (Raynaud's phenomenon) or carpal tunnel syndrome.

These conditions reduce the hand's ability to feel and regulate temperature, produce numbness and burning sensations and may cause nerve and circulation damage and tissue necrosis.

All factors which contribute to whitefinger disease are not known, but cold weather, smoking and diseases or physical conditions that affect blood vessels and blood transport, as well as high vibration levels and long periods of exposure to vibration are mentioned as factors in the development of whitefinger disease. In order to reduce the risk of whitefinger disease and carpal tunnel syndrome, please note the following:

- Most STIHL power tools are available with an anti-vibration ("AV") system designed to reduce the transmission of vibrations created by the machine to the operator's hands. An AV system is recommended for those persons using power tools on a regular or sustained basis.
- Wear gloves and keep your hands warm.
- Keep the AV system well maintained. A power tool with loose components or with damaged or worn AV elements will tend to have higher vibration levels.
- Maintain a firm grip at all times, but do not squeeze the handles with constant, excessive pressure. Take frequent breaks.

All the above-mentioned precautions do not guarantee that you will not sustain whitefinger disease or carpal tunnel syndrome. Therefore, continual and regular users should closely monitor the condition of their hands and fingers. If any of the above symptoms appear, seek medical advice immediately.

WARNING

The ignition system of the STIHL unit produces an electromagnetic field of a very low intensity. This field may interfere with some pacemakers. To reduce the risk of serious or fatal injury, persons with a pacemaker should consult their physician and the pacemaker manufacturer before operating this tool.

Proper Clothing

To reduce the risk of injury, the operator should wear proper protective apparel.

WARNING

The deflector provided with your power tool will not protect the operator from all foreign objects (gravel, glass, wire, etc.) thrown back by the rotating cutting attachment. Thrown objects may also ricochet and strike the operator.

! WARNING



To reduce the risk of injury to your eyes never operate your power tool unless wearing goggles or properly fitted protective glasses with adequate top and side protection complying with ANSI Z87 "+" (or your applicable national standard). To reduce the risk of injury to your face STIHL recommends that you also wear a face shield or face screen over your goggles or protective glasses.

Wear an approved safety hard hat to reduce the risk of injury to your head when there is a danger of head injuries.

Power tool noise may damage your hearing. Wear sound barriers (ear plugs or ear muffs) to protect your hearing. Continual and regular users should have their hearing checked regularly.

Be particularly alert and cautious when wearing hearing protection because your ability to hear warnings (shouts, alarms, etc.) is restricted.



Always wear heavy duty work gloves (e.g. made of leather or other wear resistant material) when handling the machine and metal blades. Heavy-duty, nonslip gloves improve your grip and help to protect your hands.



Clothing must be sturdy and snug-fitting, but allow complete freedom of movement. Wear long pants made of heavy material to help protect your legs. Do not wear shorts, sandals or go barefoot.

Avoid loose-fitting jackets, scarfs, neckties, jewelry, flared or cuffed pants, unconfined long hair or anything that could become caught on branches, brush or the moving parts of the unit. Secure hair so it is above shoulder level.



Good footing is very important. Wear sturdy boots with nonslip soles. Steel-toed safety boots are recommended.

THE POWER TOOL

For illustrations and definitions of the power tool parts see the chapter on "Main Parts."

! WARNING

Never modify this power tool in any way. Only attachments supplied by STIHL and expressly approved by STIHL for use with the specific STIHL model are authorized. Although certain unauthorized attachments are useable with STIHL power tools, their use may, in fact, be extremely dangerous. For the cutting attachments authorized by STIHL for your unit, see the chapter "Approved Combinations of Cutting Attachment, Deflector, Handle and Harness" in the instruction manual or the STIHL "Cutting Attachments, Parts & Accessories" catalog.

If this tool is subjected to unusually high loads for which it was not designed (e.g. heavy impact or a fall), always check that it is in good condition before continuing work. Check in particular that the fuel system is tight (no leaks) and that the controls and safety devices are working properly. Do not continue operating this machine if it is damaged. In case of doubt, have it checked by your STIHL servicing dealer.

THE USE OF THE POWER TOOL

Transporting the Power Tool

! WARNING

To reduce the risk of injury from loss of control and blade or line contact, never carry or transport your power tool with the cutting attachment moving.

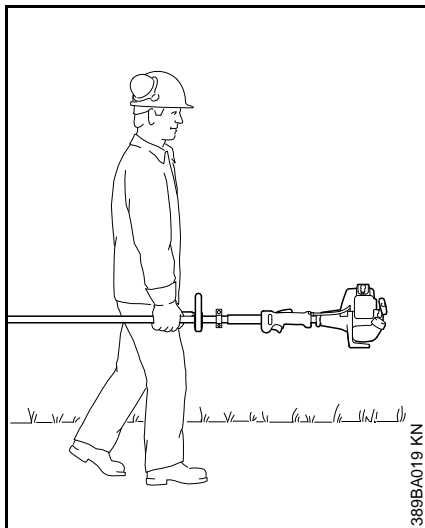

It may be carried only in a horizontal position. Grip the shaft in a manner that the machine is balanced horizontally. Keep the hot muffler away from your body and the cutting attachment behind you.

! WARNING

Always shut off the engine and make sure the cutting attachment has stopped before putting a trimmer / brushcutter down. When transporting it in a vehicle, properly secure it to prevent turnover, fuel spillage and damage to the unit. STIHL recommends that you keep metal blades covered with the transport guard (optional accessory).

Fuel

Your STIHL power tool uses an oil-gasoline mixture for fuel (see the chapter on "Fuel" of your instruction manual).

! WARNING



Gasoline is an extremely flammable fuel. If spilled and ignited by a spark or other ignition source, it can cause fire and serious burn injury or property damage. Use extreme caution when handling gasoline or fuel mix. Do not smoke or bring any fire or flame near the fuel or the power tool. Note that combustible fuel vapor may escape from the fuel system.

Fueling Instructions

! WARNING

To reduce the risk of serious injury from burns, never attempt to refuel the unit until it has been completely removed from the operator.

! WARNING

Fuel your power tool in well-ventilated areas, outdoors. Always shut off the engine and allow it to cool before refueling. Gasoline vapor pressure may build up inside the fuel tank depending on the fuel used, the weather conditions and the tank venting system.

In order to reduce the risk of burns and other personal injury from escaping gas vapor and fumes, remove the fuel filler cap on your power tool carefully so as to allow any pressure build-up in the tank to release slowly. Never remove the fuel filler cap while the engine is running.

Select bare ground for fueling and move at least 10 feet (3 m) from the fueling spot before starting the engine. Wipe off any spilled fuel before starting your machine.

! WARNING



Check for fuel leakage while refueling and during operation. If fuel leakage is found, do not start or run the engine until the leak is fixed and any spilled fuel has been wiped away. Take care not to get fuel on your clothing. If this happens, change your clothing immediately.

! WARNING

In order to reduce the risk of fuel spillage and fire from an improperly tightened fuel cap, correctly position and tighten the fuel cap in the fuel tank opening.

! WARNING



Unit vibrations can cause an improperly tightened fuel filler cap to loosen or come off and spill quantities of fuel. In order to reduce the risk of fuel spillage and fire, tighten the fuel filler cap by hand as securely as possible.

See also the "Fueling" chapter in your Instruction Manual for additional information.

Before Starting

WARNING

Always check your power tool for proper condition and operation before starting, particularly the throttle trigger, throttle trigger lockout, slide control / stop switch, cutting attachment, deflector and harness. The throttle trigger must move freely and always spring back to the idle position. Never attempt to modify the controls or safety devices.

WARNING

Check fuel system for leaks, especially the visible parts, e.g., filler cap, hose connections, manual fuel pump (only for power tools equipped with a manual fuel pump). Do not start the engine if there are leaks or damage – risk of fire! Have the machine repaired by a servicing dealer before using it.

WARNING

Never operate your power tool if it is damaged, improperly adjusted or maintained, or not completely or securely assembled.

WARNING

Do not attach any cutting attachment to a unit without proper installation of all required parts. Failure to use the proper parts may cause the blade or head to fly off and seriously injure the operator or bystanders.

WARNING

The cutting attachment must be properly tightened and in safe operating condition. Inspect for loose parts (nuts, screws, etc.) and for cracked or damaged heads or cracked, bent, warped or damaged blades. Replace damaged heads or blades before using the power tool. Always keep blades sharp.

Keep the handles clean and dry at all times; it is particularly important to keep them free of moisture, pitch, oil, fuel mix, grease or resin in order for you to maintain a firm grip and properly control your power tool.

WARNING

Check that the spark plug boot is securely mounted on the spark plug – a loose boot may cause arcing that could ignite combustible fumes and cause a fire.

WARNING



To reduce the risk of personal injury to the operator from blade or line contact and thrown objects, make sure your unit is equipped with the proper deflector, handle and harness for the type of cutting attachment being used (see chart in the chapter on "Approved Combinations of Cutting Attachment, Deflector, Handle and Harness".)

As can be seen in that chart, some cutting attachments may require you to change your deflector, handle and / or harness.

Keep the deflector (and the attached skirt where appropriate) adjusted properly at all times (see chapters on "Mounting the Deflector" and "Mounting the Cutting Attachment" of your instruction manual).

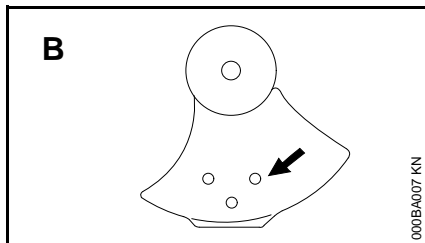
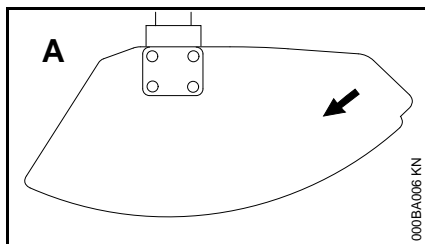

Arrows on the deflector (A) and limit stop (B) (as seen from the underside) show the correct direction of rotation of the cutting attachment. When viewed from above, however, the cutting attachment rotates counterclockwise.

Adjust carrying harness and hand grip to suit your size before starting work. The machine should be properly balanced as specified in your instruction manual for proper control and less fatigue in operation. To be better prepared in case of an emergency, practice releasing the unit from the harness as quickly as possible.

Starting

Start the engine at least 10 feet (3 m) from the fueling spot, outdoors only.

For specific starting instructions, see the appropriate section of your manual. Place the power tool on firm ground or

other solid surface in an open area. Maintain good balance and secure footing.

! WARNING

To reduce the risk of injury from blade or line contact, be absolutely sure that the cutting attachment is clear of you and all other obstructions and objects, including the ground, because when the engine starts at starting-throttle, engine speed will be fast enough for the clutch to engage and move the cutting attachment.

Once the engine has started, immediately blip the throttle trigger, which should release the starting throttle and allow the engine to slow down to idle.

With the engine running only at idle, attach the power tool to the spring hook of your harness (see appropriate chapter of this manual).

! WARNING

Your power tool is a one-person machine. Do not allow other persons in the general work area, even when starting.

! WARNING

To reduce the risk of injury from loss of control, do not attempt to "drop start" your power tool.

! WARNING

When you pull the starter grip, do not wrap the starter rope around your hand. Do not let the grip snap back, but guide the starter rope to rewind it properly.

Failure to follow this procedure may result in injury to your hand or fingers and may damage the starter mechanism.

Important Adjustments

! WARNING

To reduce the risk of personal injury from loss of control or contact with the running cutting attachment, do not use your unit with incorrect idle adjustment. At correct idle speed, the cutting attachment should not move. For directions on how to adjust idle speed, see the appropriate section of your instruction manual.

If you cannot set the correct idle speed, have your STIHL dealer check your power tool and make proper adjustments and repairs.

During Operation

Holding and Controlling the Power Tool

Always hold the unit firmly with both hands on the handles while you are working.

Wrap your fingers and thumbs around the handles, keeping the handles cradled between your thumb and forefinger. Keep your hands in this position to have your power tool under control at all times. Make sure your trimmer handles and grips are in good condition and free of moisture, pitch, oil, fuel mix or grease.

Make sure you always have good balance and secure footing.

Models with bike handle

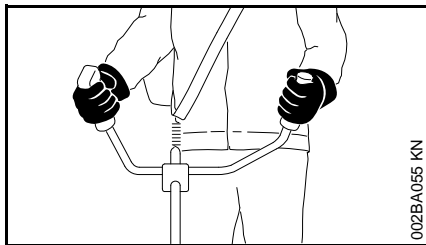

Right hand on control handle, left hand on left handle.

Models with loop handle

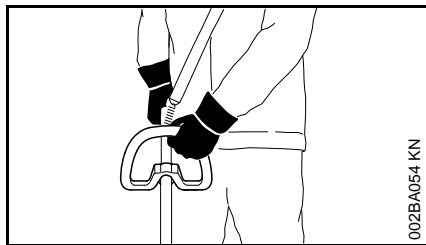

Left hand on loop handle, right hand on control handle, even if you are left-handed.

WARNING



Never attempt to operate your power tool with one hand. Loss of control of the power tool resulting in serious or fatal injury may result. To reduce the risk of cut injuries, keep hands and feet away from the cutting attachment. Never touch a moving cutting attachment with your hand or any other part of your body.

WARNING

Do not overreach. Keep proper footing and balance at all times. Special care must be taken in slippery conditions (wet ground, snow) and in difficult, overgrown terrain. Watch for hidden obstacles such as tree stumps, roots and ditches to avoid stumbling. For better footing, clear away scrub and cuttings. Be extremely cautious when working on slopes or uneven ground.

WARNING

To reduce the risk of injury from loss of control, never work on a ladder or on any other insecure support. Never hold the cutting attachment above waist height.

Working Conditions

Operate and start your power tool only outdoors in a well ventilated area. Operate it under good visibility and daylight conditions only. Work carefully.

WARNING



As soon as the engine is running, this product generates toxic exhaust fumes containing chemicals, such as unburned hydrocarbons (including benzene) and carbon monoxide, that are known to cause respiratory problems, cancer, birth defects, or other reproductive harm. Some of the gases (e.g. carbon monoxide) may be colorless and odorless. To reduce the risk of serious or fatal injury / illness from inhaling toxic fumes, never run the machine indoors or in poorly ventilated locations.

WARNING

If the vegetation being cut or the surrounding ground is coated with a chemical substance (such as an active pesticide or herbicide), read and follow the instructions and warnings that accompanied the substance at issue.

WARNING

Inhalation of certain dusts, especially organic dusts such as mold or pollen, can cause susceptible persons to have an allergic or asthmatic reaction. Substantial or repeated inhalation of dust and other airborne contaminants, in particular those with a smaller particle size, may cause respiratory or other illnesses. Control dust at the source

where possible. Use good work practices, such as operating the unit so that the wind or operating process directs any dust raised by the power tool away from the operator. Follow the recommendations of EPA / OSHA / NIOSH and occupational and trade associations with respect to dust ("particulate matter"). When the inhalation of dust cannot be substantially controlled, i.e., kept at or near the ambient (background) level, the operator and any bystanders should wear a respirator approved by NIOSH / MSHA for the type of dust encountered.

Operating Instructions

WARNING

Do not operate your power tool using the starting throttle lock, as you do not have control of the engine speed.

In the event of an emergency, shut off the engine immediately – move the slide control / stop switch to **0** or **STOP**.

WARNING



The cutting attachment continues to rotate for a short period after the throttle trigger is released (flywheel effect.)

WARNING

The rotating cutting attachment may fling foreign objects directly or by ricochet a great distance.

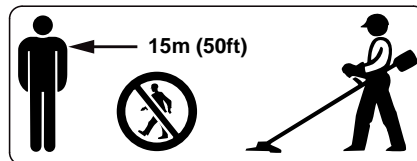

To reduce the risk of eye and other injury always wear proper eye protection (see the chapter on "Proper Clothing") and ensure that bystanders are at least 50 feet (15 m) away. To reduce the risk of damage to property, also maintain this distance from such objects as vehicles or windows. Even maintaining a minimum distance of 15 meters cannot exclude the potential danger. Any coworkers who must be in the restricted area should also wear goggles or protective glasses. Stop the engine immediately if you are approached.

WARNING



Inspect the work area: To reduce the risk of injury, remove stones, pieces of metal and other solid objects which could be thrown 15 meters or more by the cutting attachment or damage the cutting attachment and property (e.g. parked vehicles, windows).



WARNING

This trimmer / brushcutter is normally to be used at ground level with the cutting attachment parallel to the ground. Use of a trimmer / brushcutter above ground level or with the cutting attachment perpendicular to the ground may

increase the risk of injury, since the cutting attachment is more fully exposed and the power tool may be more difficult to control. Never use your trimmer / brushcutter as a hedge trimmer.

WARNING

During cutting, check the tightness and the condition of the cutting attachment at regular short intervals with the engine and attachment stopped. If the behavior of the attachment changes during use, stop the engine immediately, wait until the cutting attachment stops, and check the nut securing the attachment for tightness and the blade or head for cracks, wear and damage.

WARNING

A loose blade or head may vibrate, crack, break or come off the trimmer / brushcutter, which may result in serious or fatal injury. Make sure that the cutting attachment is properly tightened. Use the wrench supplied or one of sufficient length to obtain the proper torque. If the blade or head loosens after being properly tightened, stop work immediately. The retaining nut may be worn or damaged and should be replaced. If the blade or head continues to loosen, see your STIHL dealer. Never use a trimmer / brushcutter with a loose cutting attachment.

WARNING

Replace a cracked, damaged or worn-out head or a cracked, bent, warped, damaged, dull or worn out blade immediately, even if damage is limited to

superficial cracks. Such attachments may shatter at high speed and cause serious or fatal injury.

 **WARNING**

When using rigid blades, avoid cutting close to fences, sides of buildings, tree trunks, stones or other such objects that could cause the power tool to kick out or could cause damage to the blade.

STIHL recommends use of the nylon line heads for such jobs. In addition, be alert to an increased possibility of ricochets in such situations.

 **WARNING**

If a rotating metal blade strikes a rock or other hard object, sparks may be created, which can ignite flammable materials under certain circumstances. Flammable materials can include dry vegetation and brush, particularly when weather conditions are hot and dry. When there is a risk of fire or wildfire, do not use metal blades around flammable materials or around dry vegetation or brush. Contact your local fire authorities or the U.S. Forestry Service if you have any question about whether vegetation and weather conditions are suitable for the use of a metal blade.

 **WARNING**

If the head, blade or deflector becomes clogged or stuck, always shut off the engine and make sure the cutting attachment has stopped before cleaning. Grass, weeds, etc. should be cleaned off the blade or from around the head at regular intervals.

 **WARNING**

To reduce the risk of unintentional rotation of the cutting attachment and injury, always shut off the engine and remove the spark plug boot before replacing the cutting attachment. To reduce the risk of injury, always shut off the engine before adjusting the length of the nylon line on manually adjustable mowing heads.

 **WARNING**

The gearbox becomes hot during operation. To reduce the risk of burn injury, do not touch the gear housing when it is hot.

 **WARNING**

Never modify your muffler. Any modification could cause an increase in heat radiation, sparks or sound level, thereby increasing the risk of fire, burn injury or hearing loss. You may also permanently damage the engine. Have your muffler serviced and repaired by your STIHL servicing dealer only.

 **WARNING**

The muffler and other parts of the engine (e.g. fins of the cylinder, spark plug) become hot during operation and remain hot for a while after stopping the engine. To reduce risk of burns, do not touch the muffler and other parts while they are hot. Keep the area around the muffler clean. Remove excess lubricant and all debris such as pine needles, branches or leaves. Let the engine cool down

sitting on concrete, metal, bare ground or solid wood (away from any combustible substances).

 **WARNING**

An improperly mounted or damaged cylinder housing or a damaged/deformed muffler shell may interfere with the cooling process of the muffler. To reduce the risk of fire or burn injury, do not continue work with a damaged or improperly mounted cylinder housing or a damaged/deformed muffler shell.

Your muffler is furnished with a spark arresting screen designed to reduce the risk of fire from the emission of hot particles. Never operate your unit with a missing or damaged spark arresting screen. If your gas/oil mix ratio is correct (i.e., not too rich), this screen will normally stay clean as a result of the heat from the muffler and need no service or maintenance. If you experience loss of performance and you suspect a clogged screen, have your muffler maintained by a STIHL servicing dealer. Some state or federal laws or regulations may require a properly maintained spark arrestor for certain uses. See the "Maintenance, Repair and Storing" section of these Safety Precautions. Remember that the risk of a brush or forest fire is greater in hot or dry conditions.

! WARNING



Some STIHL power tools are equipped with a catalytic converter, which is designed to reduce the exhaust emissions of the engine by a chemical process in the muffler. Due to this process, the muffler does not cool down as rapidly as conventional mufflers when the engine returns to idle or is shut off. To reduce the risk of fire and burn injuries when using a catalytic converter, always set your power tool down in the upright position and never locate it where the muffler is near dry brush, grass, wood chips or other combustible materials while it is still hot.

USING THE CUTTING ATTACHMENT

For an illustration of the various cutting attachments and instructions on proper mounting see the chapter on "Mounting the Cutting Attachment" in your instruction manual.

! WARNING

To reduce the risk of severe or fatal injury from blade contact and / or loss of control, never attempt to use a metal blade on an FS model for which it is not authorized.

Using the Mowing Heads

Do not use with mowing line longer than the intended length. With a properly mounted deflector, the built-in line-limiting blade will automatically adjust the line to its proper length.

Using the unit with an overly long nylon cutting line increases the load on the engine and reduces its operating speed. This causes the clutch to slip continuously and results in overheating and damage to important components (e.g. clutch, polymer housing components). Such damage could, among other things, cause the cutting attachment to rotate at idle.

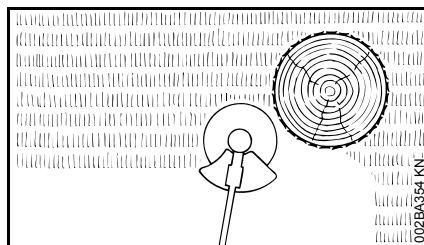

Mowing heads are to be used only on trimmers / brushcutters equipped with a line-limiting blade in the deflector in order to keep the line at the proper length (see "Main Parts" chapter in your instruction manual).

If the lawn edges are planted with trees or bordered by a fence etc., it is best to use a nylon line head. It achieves a "softer" cut with less risk of damaging tree bark etc. than polymer blades.

However, the polymer-bladed STIHL PolyCut produces a better cut if there are no plants along the edge of the lawn. Sharpening is not necessary, and worn polymer blades are easily replaced.

! WARNING

To reduce the risk of serious injury, never use wire or metal-reinforced line or other material in place of the nylon cutting lines. Pieces of wire could break off and be thrown at high speed toward the operator or bystanders.

STIHL SuperCut mowing head

Fresh line is advanced automatically. Frayed line is replaced by a simple adjustment (see instruction sheet supplied with mowing head).

STIHL AutoCut mowing head

Nylon cutting line advances automatically when tapped against the ground (TapAction).

STIHL TrimCut mowing head

Frayed line is replaced by a simple adjustment (see instruction sheet supplied with mowing head).

STIHL PolyCut mowing head

Uses either nylon lines or nonrigid, pivoting polymer blades.

Observe wear indicators.

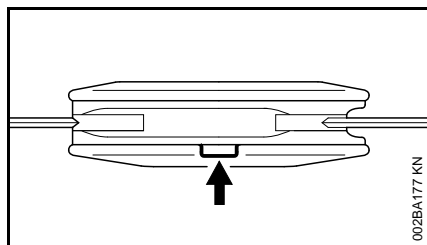

! WARNING

Three rectangular wear limit marks are applied to the base (periphery) of the PolyCut. To reduce the risk of serious injury from breakage of the head or blades, the PolyCut must not be used when it has worn as far as one of these marks. It is important to follow the maintenance instructions supplied with the head.

STIHL FixCut mowing head

Uses pre-cut lengths of nylon line.

Observe wear indicators.

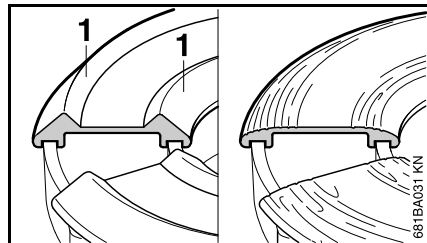

Do not continue using the mowing head if the raised moldings (1) on the base are missing or worn – see right illustration above. The mowing head may otherwise shatter and flying objects could result in injury to the operator or bystanders. Install a new mowing head.

Risk of Kickout (Blade Thrust) with all Rigid Cutting Blades

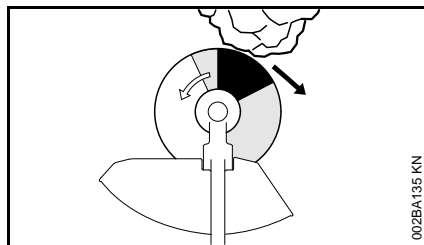

! WARNING



Kickout (blade thrust) is the sudden and uncontrolled motion towards the operator's right or rear that can occur when the shaded area (especially the darkly shaded area) of a rotating blade comes in contact with a solid rigid object like a tree, rock, bush or wall. The rapid counterclockwise rotation of the blade may be stopped or slowed, and the cutting attachment may be thrown to the right or to the rear.

This kickout (blade thrust) may cause loss of control of the power tool and may result in serious or fatal injury to the operator or bystanders. To reduce the risk of injury, extreme caution should be used when cutting with the shaded area of any rigid blade.

Using the Grass Cutting Blade

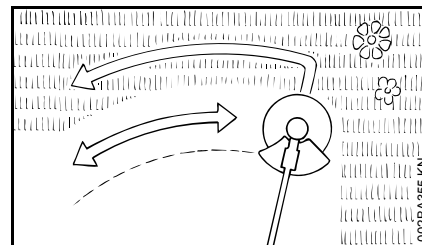

All kinds of grass and weeds can be easily cut with the grass cutting blade. The power tool is swept in an arc similar to a scythe.

! WARNING

To reduce the risk of serious or fatal injury from blade breakage, never attempt to use this blade to cut woody materials.

The **4-tooth** grass cutting blade is intended to cut grass and weeds. It has 4 cutting knives with cutting edges on both sides, i.e. front and rear. When the cutting edges on one side become dull, the blade can be turned over to utilize the cutting edges on the other side.

The **8-tooth** grass cutting blade is recommended for cutting fern or reed.

Both types of grass cutting blade have to be resharpened when all cutting edges are dull.

Using the Brush Knife

When fitted to the power tool, the brush knife is suitable for applications ranging from cutting matted grass to clearing weeds, wild growth and scrub.

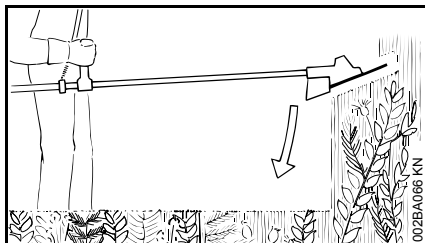

To cut wild growth and scrub, lower the rotating brush knife down onto the growth to achieve a chopping effect – but keep the tool below waist height at all times.

! WARNING

Exercise **extreme caution** when using this method of cutting. The higher the cutting attachment is off the ground, the greater the risk of loss of control and of cuttings being thrown sideways.

Use the power tool like a scythe to cut grass, i.e. sweep it to and fro in an arc.

! WARNING

When cutting woody materials, use the left side of the blade to avoid "kickout" (blade thrust) situations.

! WARNING

Improper use of a brush knife may cause it to crack, chip or shatter. Thrown blade fragments may seriously or fatally injure the operator or bystanders. To reduce the risk of injury, avoid contact with hard or solid foreign objects such as stones, rocks or pieces of metal.

! WARNING

When cutting young saplings or other woody materials up to 2 cm (3/4 in.) in diameter, use the left side of the blade to avoid "kickout" situations (see section on "Risk of kickout (blade thrust) with all rigid cutting blades"). Do not attempt to cut woody material with a larger diameter, since the blade may catch or jerk the power tool forward. This may cause damage to the blade or power tool or loss of control of the power tool, resulting in personal injury. Use a circular saw blade for such work.

! WARNING

Inspect the brush knife at regular short intervals for signs of damage. Do not continue working with a damaged brush knife. Resharpener the brush knife regularly (when it has dulled noticeably).

Using the Circular Saw Blade

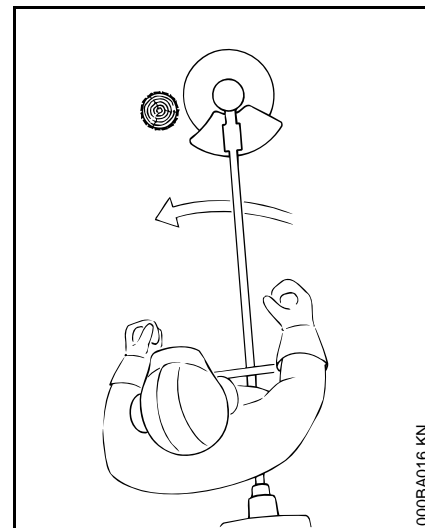

Circular saw blades are suitable for thinning brush and cutting small trees up to a diameter of 4 cm (1 1/2 in.). Do not attempt to cut trees with larger diameters, since the blade may catch or jerk the trimmer / brushcutter forward. This may cause damage to the blade or loss of control of the power tool and result in serious injury. Use a chain saw for such work.

! WARNING

To reduce the risk that the blade will crack and / or break, avoid all contact with stones, rocks or the ground. Sharpen blades in a timely manner as specified – dull teeth may cause the blade to crack or shatter.

When a trimmer / brushcutter with a circular saw blade is used to cut down small trees, STIHL recommends that the standard deflector be removed and

replaced by the special limit stop deflector (see chapter on "Mounting the Deflector"). This limit stop helps to keep the unit positioned against the tree during the cutting process.

Inexperienced users should place the left side of the stop against the tree trunk before beginning to cut. This will keep the trimmer / brushcutter against the tree during the cutting operation and will reduce the risk of loss of control and possible kickout (described above and briefly again below).

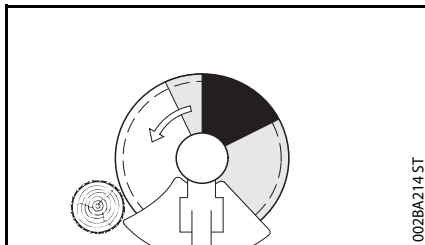

Before starting the cut, accelerate the engine up to full throttle. Perform cut with uniform pressure. STIHL recommends that the circular saw blade be applied to the right of the tree, using the non-shaded area of the blade, as shown in the illustration above.

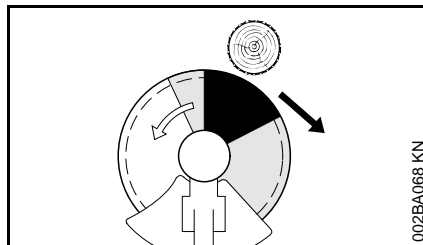

! WARNING

The risk of kickout is highest when cutting in the darker shaded area. To reduce the risk of kickout and resulting injury, do not use this area of the circular saw blade for cutting trees or shrubs. Special techniques using the lighter shaded areas of the blade to cut shrubs and trees should only be used by experienced operators with specialized training in the use and control of the trimmer / brushcutter.

! WARNING

To reduce the risk of loss of control and serious injury to the operator or bystanders by a kickout, never use a circular saw blade on a trimmer / brushcutter with a loop handle, but rather only on one with a bicycle handle.

When felling small trees, maintain a distance of at least two tree lengths from the nearest coworker.

! WARNING

In order to reduce the risk of injury from thrown objects or operator contact with the blade or head, be sure to remount the standard deflector when no longer using a circular saw blade.

MAINTENANCE, REPAIR AND STORING

Maintenance, replacement, or repair of the emission control devices and systems may be performed by any nonroad engine repair establishment or individual. However, if you make a warranty claim for a component which has not been serviced or maintained properly or if nonapproved replacement parts were used, STIHL may deny coverage.

! WARNING

Use only identical STIHL replacement parts for maintenance and repair. Use of non-STIHL parts may cause serious or fatal injury.

Strictly follow the maintenance and repair instructions in the appropriate sections of your instruction manual.

! WARNING

Always stop the engine and make sure that the cutting attachment is stopped before doing any maintenance or repair work or cleaning the power tool. Do not attempt any maintenance or repair work not described in your instruction manual. Have such work performed by your STIHL servicing dealer only.

Wear gloves when handling or performing maintenance on blades.

! WARNING

Use the specified spark plug, and make sure it and the ignition lead are always clean and in good condition. Always press the spark plug boot snugly onto

the spark plug terminal of the proper size. (Note: If the terminal has a detachable SAE adapter nut, it must be securely attached.) A loose connection between the spark plug and the ignition wire connector in the boot may create arcing that could ignite combustible fumes and cause a fire.

 **WARNING**

Never test the ignition system with the spark plug boot removed from the spark plug or with a removed spark plug, since uncontained sparking may cause a fire.

 **WARNING**

Do not operate your power tool if the muffler is damaged, missing or modified. An improperly maintained muffler will increase the risk of fire and hearing loss. Your muffler is equipped with a spark-arresting screen to reduce the risk of fire; never operate your power tool if the screen is missing, damaged or clogged. Remember that the risk of a brush or forest fire is greater in hot or dry weather.

In California, it is a violation of § 4442 or § 4443 of the Public Resources Code to use or operate gasoline-powered tools on forest-covered, brush-covered or grass-covered land unless the engine's exhaust system is equipped with a complying spark arrester that is maintained in effective working order. The owner/operator of this product is responsible for properly maintaining the spark arrester. Other states or governmental entities/agencies, such as the U.S. Forest Service, may have similar requirements. Contact your local

fire agency or forest service for the laws or regulations relating to fire protection requirements.

 **WARNING**

Never repair damaged cutting attachments by welding, straightening or modifying the shape. This may cause parts of the cutting attachment to come off and result in serious or fatal injuries.

Keep blades sharp. Tighten all nuts, bolts and screws, except the carburetor adjustment screws, after each use.

Do not clean your machine with a pressure washer. The solid jet of water may damage parts of the machine.

Store the power tool in a dry and high or locked location out of reach of children.

Before storing for longer than a few days, always empty the fuel tank. See chapter "Storing the Machine" in the instruction manual.

Maintenance and Care

| The following intervals apply for normal operating conditions. The specified intervals must be shortened accordingly when working for longer than normal or under difficult cutting conditions (extensive dust, etc.). | | Before starting work | At the end of work and/or daily | Whenever tank is refilled | Weekly | Monthly | Annually | If faulty | If damaged | As required |
|--|---|----------------------|---------------------------------|---------------------------|--------|---------|----------|-----------|------------|-------------|
| Complete machine | Visual inspection (condition, leaks) | X | | X | | | | | | |
| | Clean | | X | | | | | | | |
| | Replace any damaged parts | X | | | | | | | X | |
| Control handle | Function test | X | | X | | | | | | |
| Air filter | Visual inspection | | | | | X | | X | | |
| | Clean | | | | | | | X | | X |
| | replace | | | | | | | | X | |
| Manual fuel pump (if present) | check | X | | | | | | | | |
| | Have repaired by a specialist dealer ¹⁾ | | | | | | | | X | |
| Fuel pickup body in fuel tank | Have checked by dealer ¹⁾ | | | | | | | X | | |
| | Have replaced by servicing dealer ¹⁾ | | | | | | X | | X | X |
| Fuel tank | Clean | | | | | | | X | | X |
| Carburetor | Check idle adjustment, cutting attachment must not turn | X | | X | | | | | | |
| | Adjust idle speed | | | | | | | | | X |
| Spark plug | Set electrode gap | | | | | | | X | | |
| | Replace after every 100 hours of operation | | | | | | | | | |
| Cooling air intakes | Visual inspection | | X | | | | | | | |
| | Clean | | | | | | | | | X |
| Cylinder fins | Clean ²⁾ | | | | | | X | | | |
| Valve clearance | Check and adjust if necessary, once after 139 hours of operation, by servicing dealer ¹⁾ | | | | | | | | | X |

| The following intervals apply for normal operating conditions. The specified intervals must be shortened accordingly when working for longer than normal or under difficult cutting conditions (extensive dust, etc.). | | Before starting work | At the end of work and/or daily | Whenever tank is refilled | Weekly | Monthly | Annually | If faulty | If damaged | As required |
|--|--|----------------------|---------------------------------|---------------------------|--------|---------|----------|-----------|------------|-------------|
| Combustion chamber (CARB only) | Have cleaned after 139 hours of operation, afterwards after every 150 hours of operation by dealer ¹⁾ | | | | | | | | | X |
| Spark arresting screen in muffler | Check | | X | | | | | X | | |
| | Clean or replace | | | | | | | | X | X |
| All accessible screws, nuts and bolts (not adjusting screws) | Tighten | | | | | | | | | X |
| Anti vibration elements (rubber buffers, springs) | Check | X | | | | | | X | | X |
| | Have replaced by servicing dealer ¹⁾ | | | | | | | | X | |
| Cutting attachment | Visual inspection | X | | X | | | | | | |
| | replace | | | | | | | | X | |
| | Check for secure fit | X | | X | | | | | | |
| Metal cutting attachment | sharpen | X | | | | | | | | X |
| Gear lubrication, gear(box) lubrication | check | | | | X | | | | | |
| | top up | | | | | | | | | X |
| Safety information label | replace | | | | | | | | X | |

1) STIHL recommends STIHL dealers

2) Remove the shroud, see "Spark arresting screen in the muffler"

Main Parts

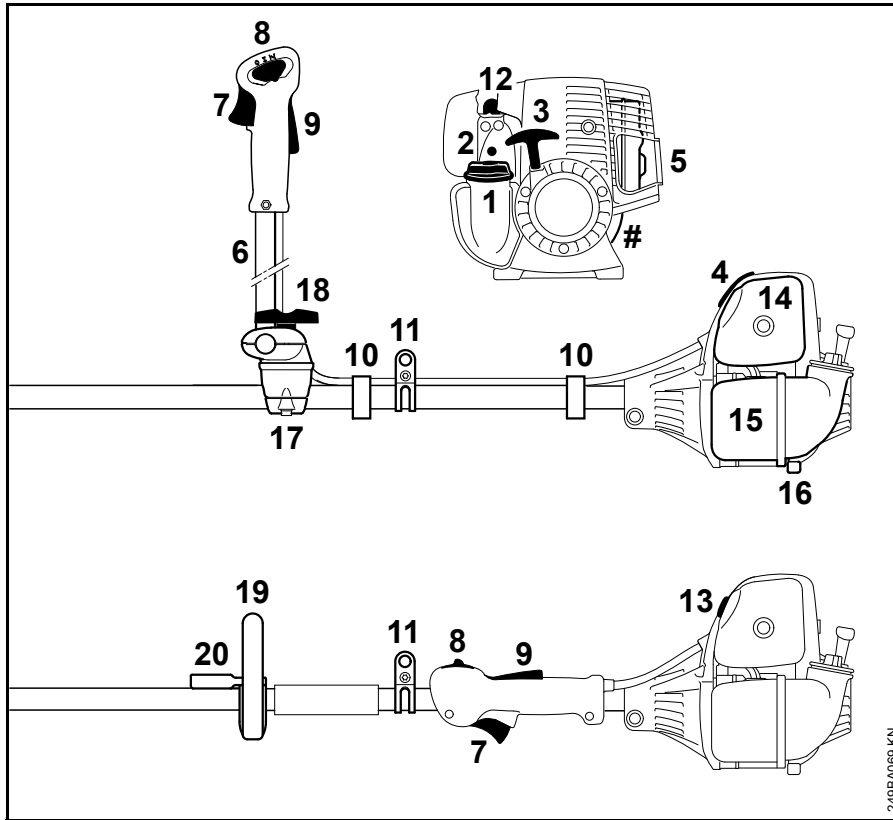

- 1 Fuel Filler Cap
- 2 Carburetor Adjusting Screws
- 3 Starter Grip
- 4 Spark Plug Boot
- 5 Muffler with Spark Arresting Screen
- 6 Bike Handle
- 7 Throttle Trigger
- 8 Slide Control
- 9 Throttle Trigger Lockout
- 10 Throttle Cable Retainer
- 11 Carrying Ring
- 12 Manual Fuel Pump
- 13 Choke Knob
- 14 Air Filter Cover
- 15 Fuel Tank
- 16 Machine Support
- 17 Handle Support
- 18 Wing Screw
- 19 Loop Handle
- 20 Barrier Bar
- # Serial Number

Definitions

- 1 Fuel Filler Cap**
For closing the fuel tank.
- 2 Carburetor Adjusting Screws**
For tuning the carburetor.
- 3 Starter Grip**
The grip of the pull starter, for starting the engine.
- 4 Spark Plug Boot**
Connects the spark plug with the ignition lead.
- 5 Muffler with Spark Arresting Screen**
Muffler reduces engine exhaust noise and diverts exhaust gases away from operator.
Spark arresting screen is designed to reduce the risk of fire.
- 6 Bike Handle**
For easy control of the machine with both hands during cutting work.
- 7 Throttle Trigger**
Controls the speed of the engine.
- 8 Slide Control**
For starting throttle, run and stop.
Keeps the choke partially open during starting and switches off the ignition to stop the engine.
- 9 Throttle Trigger Lockout**
Must be depressed before the throttle trigger can be activated.
- 10 Throttle Cable Retainer**
Secures the throttle cable to the drive tube.
- 11 Carrying Ring**
Connects the trimmer/brushcutter to the harness.
- 12 Manual Fuel Pump**
Provides additional fuel feed for a cold start.
- 13 Choke Knob**
Eases engine starting by enriching mixture.
- 14 Air Filter Cover**
Encloses and protects the air filter element.
- 15 Fuel Tank**
For fuel and oil mixture.
- 16 Machine Support**
For resting machine on the ground.
- 17 Handle Support**
Connects the shaft and bike handle.
- 18 Wing Screw**
Locks handlebar in selected position.
- 19 Loop Handle**
For easy control of machine during cutting work.
- 20 Barrier Bar**
Helps keep user's feet and legs clear of the cutting tool.

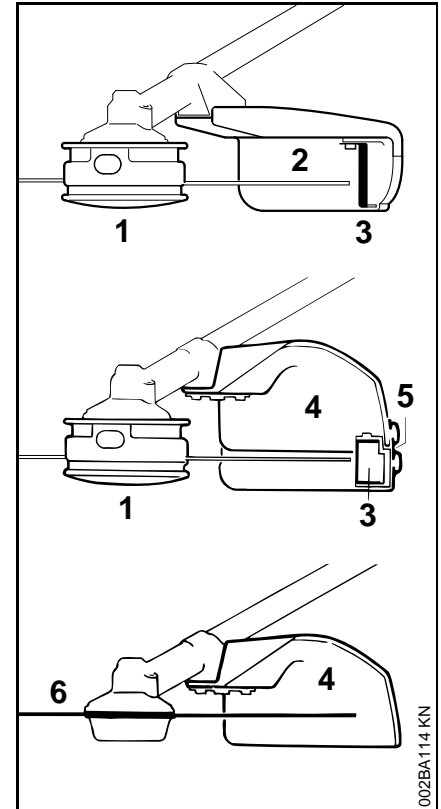

- 1** Mowing Head
- 2** Deflector for Mowing Heads
- 3** Line Limiting Blade
- 4** Deflector with Skirt for all Mowing Attachments
- 5** Skirt
- 6** Metal Mowing Tool

002BA114 KN

Definitions

1 Mowing Head

The cutting attachment, i. e. mowing head, for different purposes.

2 Deflector for Mowing Heads

The deflector is designed to reduce the risk of injury from foreign objects flung backwards toward the operator by the cutting attachment and from contact with the cutting attachment.

3 Line Limiting blade

Metal blade at the deflector in order to keep the line of the mowing head at the proper length.

4 Deflector with Skirt for all Mowing Attachments

The deflector is designed to reduce the risk of injury from foreign objects flung backwards toward the operator by the cutting attachment and from contact with the cutting attachment. Is not designed to contain fragmented metal blades.

5 Skirt

The skirt at the bottom of the deflector must be utilized as described in the chapter "Mounting the Deflector".

6 Metal Mowing Tool

The cutting attachment, i. e. blade, made from metal for different purposes.

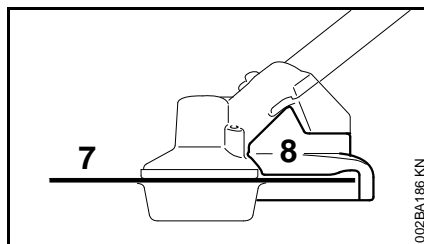

7 Circular Saw Blade

8 Limit Stop for Circular Saw Blade

Definitions

7 Circular Saw Blade

Cutting attachment made of metal for cutting wood.

8 Limit Stop for Circular Saw Blade

Is designed to position the brushcutter steady against the wood in order to reduce the risk of injury from loss of control from reactive forces such as thrust out.

 **WARNING**

The engine exhaust from this product contains chemicals known to the State of California to cause cancer, birth defects or other reproductive harm.

0457-187-3021

englisch USA



www.stihl.com



0457-187-3021